

2000 BAMBI

SECTION I

A through C

APPLIANCES

Air Conditioner	I-1
Furnace	I-1
Range	I-1
Refrigerator	I-1
Water Heater	I-1

BODY

End shell, aft	I-3
End shell, front	I-5
Roof	I-7
RS wall	I-9
CS wall	I-11
Body interior	I-12

CHASSIS

Axles	I-13
Shocks	I-13
Tire & wheel	I-13
Jacks	I-13
Step	I-13
Rear bumper/hose carrier	I-13
Under belly metal	I-14
Coupler, hitch	I-14
Brakes, 12"	I-15

2000 BAMBI

SECTION II

D through E

[DECALS/EXTERIOR TRIM](#) II-1

DOORS/WINDOWS/AWNING

[Doors](#)..... II-2

[Windows](#) II-3

[Awning](#)..... II-3

[DRAPES/BLINDS/VALANCES](#) II-4

ELECTRICAL

[110 volt](#) II-5

[12 volt](#) II-6

ENTERTAINMENT

[Radio/antenna](#)..... II-8

2000 BAMBI

SECTION III

F through H

FASTENERS (common fasteners available locally are not listed)

[Rivets](#) III-1

FLOOR COVERING

[Carpet](#) III-3

[Mats](#) III-3

FURNITURE

[Interior doors](#) III-4

[Mirrors](#) III-4

[Drawer](#) III-4

[Rear bedroom](#) III-5

[Bath](#) III-5

[Galley](#) III-6

[Lounge](#) III-6

HARDWARE

[Exterior locks/hinges](#) III-7

[Interior drawer slides/hinges latches](#) III-11

[Bath, wardrobe, misc. accessories](#) III-14

[Awning hardware](#) III-16

2000 BAMBI

SECTION IV

L through Z

LABELS and TAGS IV-1

PLUMBING

LPG IV-2

Fresh water IV-3

Faucets IV-4

Drain water IV-8

Toilet IV-12

SAFETY EQUIPMENT IV-14

SEALER/GASKETS/PAINT IV-15

UPHOLSTERY/FOAM/MATTRESS IV-16

VENTS/FANS IV-17

WOOD/LAMINATES/TRIM IV-18

2000 BAMBI

SECTION I

A through C

APPLIANCES

Air Conditioner	I-1
Furnace.....	I-1
Microwave	I-1
Range	I-1
Refrigerator	I-1
Water Heater	I-1

BODY

End shell, aft.....	I-3
End shell, front.....	I-5
Roof	I-7
RS wall.....	I-9
CS wall.....	I-11
Body interior	I-12

CHASSIS

Axles	I-13
Shocks	I-13
Tire & wheel.....	I-13
Jacks	I-13
Step	I-13
Rear bumper/hose carrier	I-13
Under belly metal	I-14
Coupler, hitch.....	I-14
Brakes, 12"	I-15

2000 BAMBI APPLIANCES

195329-143	Air conditioner, 11, 000 Dometic
201809	Pan, drain, air conditioner
690323-03	Heat strip, Dometic air conditioner
690323-100	Shroud, exterior, Penguin
690323-05	Air box/return grill
690395	Furnace, Hydroflame, 7916-II
600193	Hose, 2", flex heat duct
511228	Thermostat, furnace, off white
601224-03	Register, Rotaire, black
690396-01	Range/oven, 22" Maytag
690396-03	Bi-fold cover
690393-01	Refrigerator, Dometic, RM2452RH
690394	Power ventilator, refrigerator
964385-28	Door panel, refrigerator, 19.62" x 30.50
690199	Water heater, electronic ignition
690209	Access door, brushed aluminum

2000 BAMBI

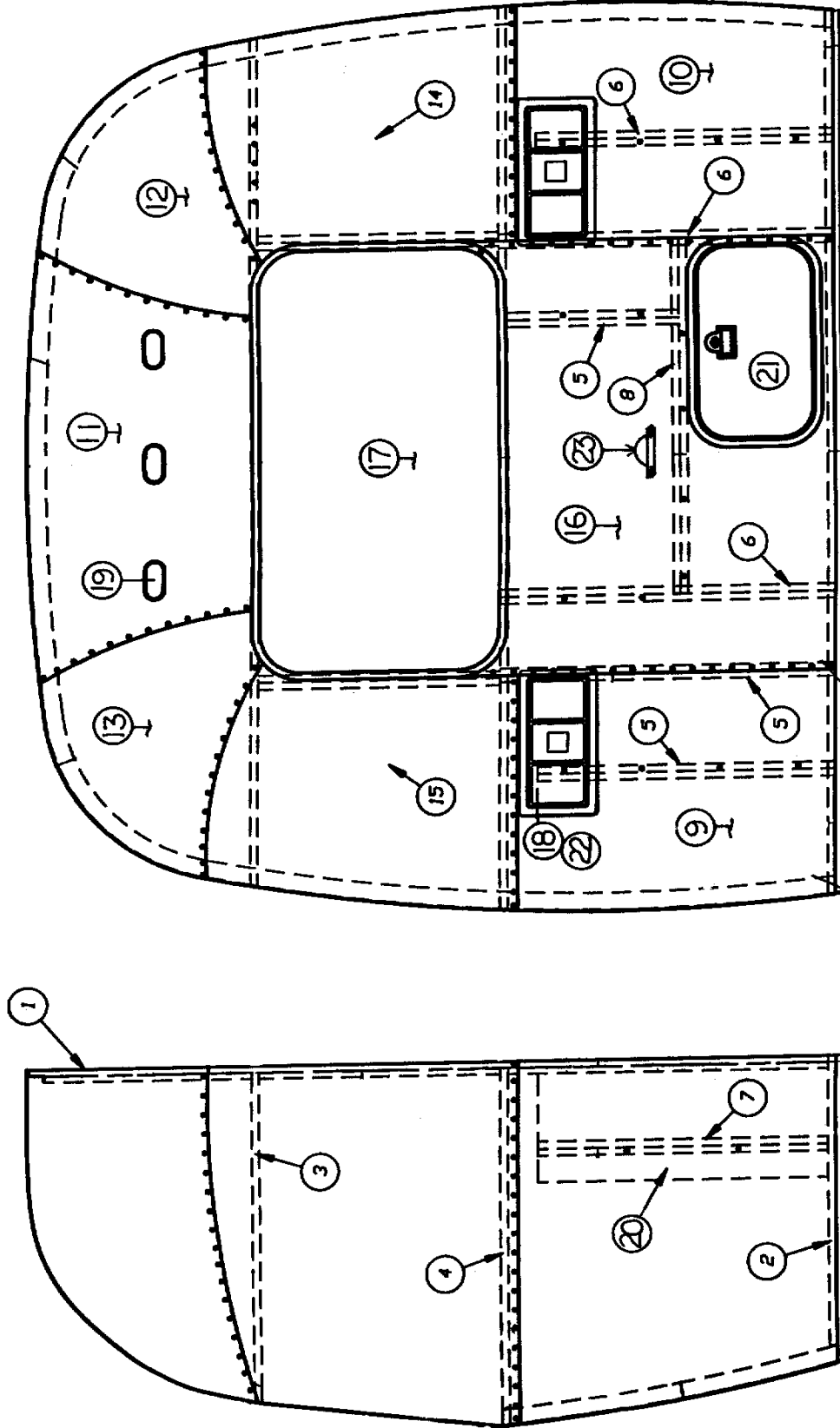

2000 BAMBI

BODY-AFT END

964513 End shell complete, rear, Bambi

- 1) 114371 End bow
- 2) 104463 Floor bow
- 3) 104351 Upper window bow
- 4) 104343 Lower window bow
- 5) 114505-01 Support, lower end, LH
- 6) 114505-02 Support, lower end, RH
- 7) 101315 Brace, vertical rear
- 8) 104408 Extrusion, Z rib
- 9) 114895 Segment #29
- 10) 114894 Segment #28
- 11) 114892 Segment #25(narrow)
- 12) 114890 Segment #26
- 13) 114891 Segment #27
- 14) 114889 Segment, center right
- 15) 114888 Segment, center left
- 16) NPN Alum .sheet, .050" x 41" x 45.25" x 51.0
(cut from 114880)
- 17) 371362 Window, rear egress, 43.94" x 24.19
- 18) 500500 Taillight complete
- 19) 510111 Clearance light, red
- 20) NPN Alum. sheet, .040" x 12.0" x 29.0 (cut from 114880)
- 21) 100679-01 Door assembly, access
- 22) 201462 Pocket, ABS taillight
- 23) 500053 Light and license plate holder

2000 BAMBI

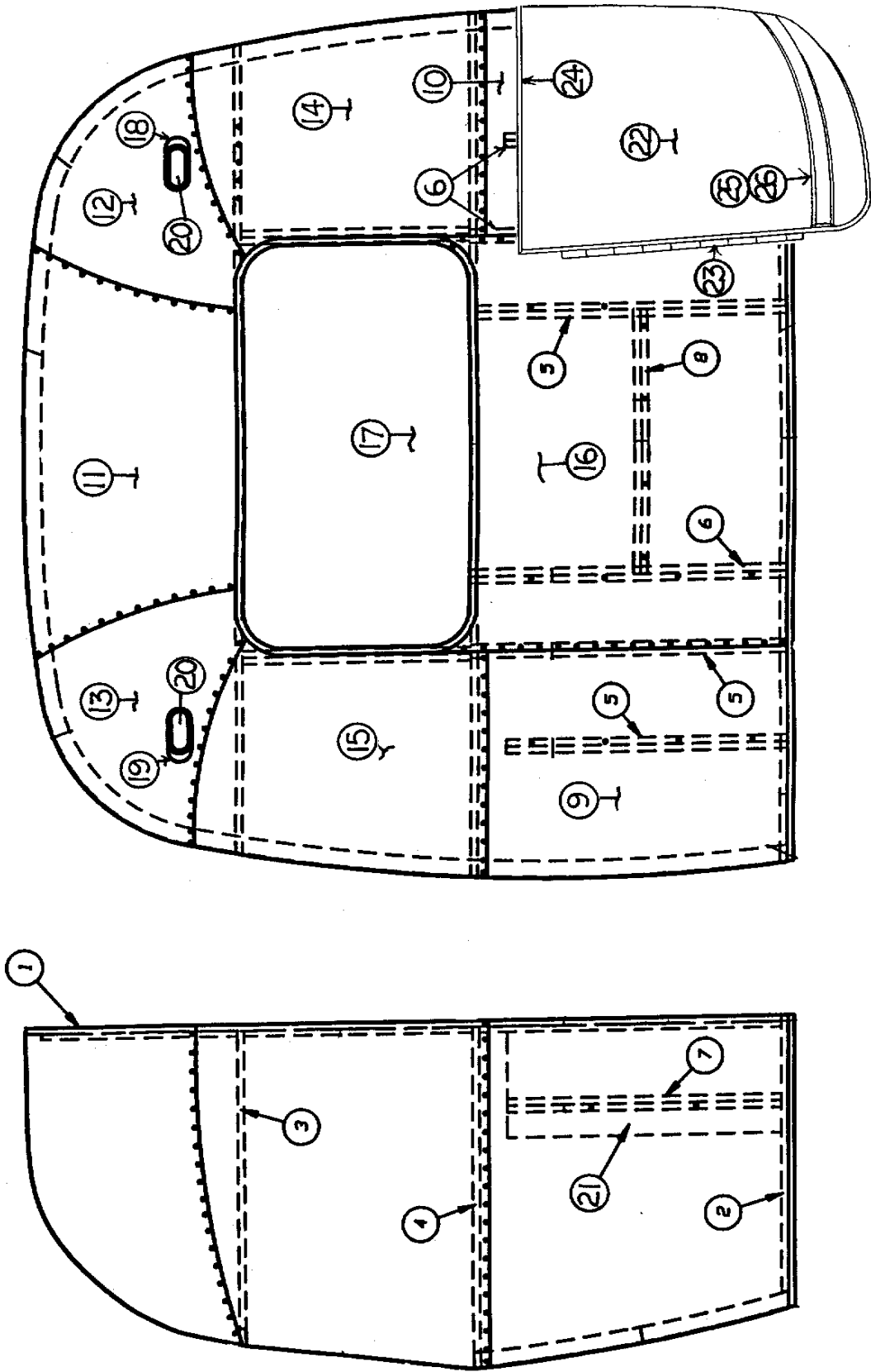

2000 BAMBI

BODY-FRONT END

964512 End shell complete, front, Bambi

- 1) 114371 End bow
- 2) 104463 Floor bow
- 3) 104351 Upper window bow
- 4) 104343 Lower window bow
- 5) 114505-01 Support, lower end, LH
- 6) 114505-02 Support, lower end, RH
- 7) 101315 Brace, vertical rear
- 8) 104408 Extrusion, Z rib
- 9) 114895 Segment #29
- 10) 11489 4Segment #28
- 11) 114892 Segment #25(narrow)
- 12) 114890 Segment #26
- 13) 114891 Segment #27
- 14) 114889 Segment, center right
- 15) 114888 Segment, center left
- 16) NPN Alum. sheet, .050" x 41.0" x 45.25 (cut from 114880)
- 17) 371362-10 Window, 43.94" x 24.19, Bambi
- 18) 101177 Base , lamp, cast polished, RS
- 19) 101178 Base, lamp, cast polished, CS
- 20) 510112 Clearance light, amber
- 21)) NPN Alum. sheet, .040x12.0x29.0(cut from 114880)
- 22) 685366-100 Wrap protector, RS, Safari/Bambi
- 22a) 685365-100 Wrap protector, CS, Safari/Bambi
- 23) 381605-01 Hinge, stainless, wrap protector
- 24) 100742-01 Extrusion, mirror/wrap protector trim
- 25) 114460 Extrusion, rub rail
- 26) 201763-01 Insert, rub rail

2000 BAMBI

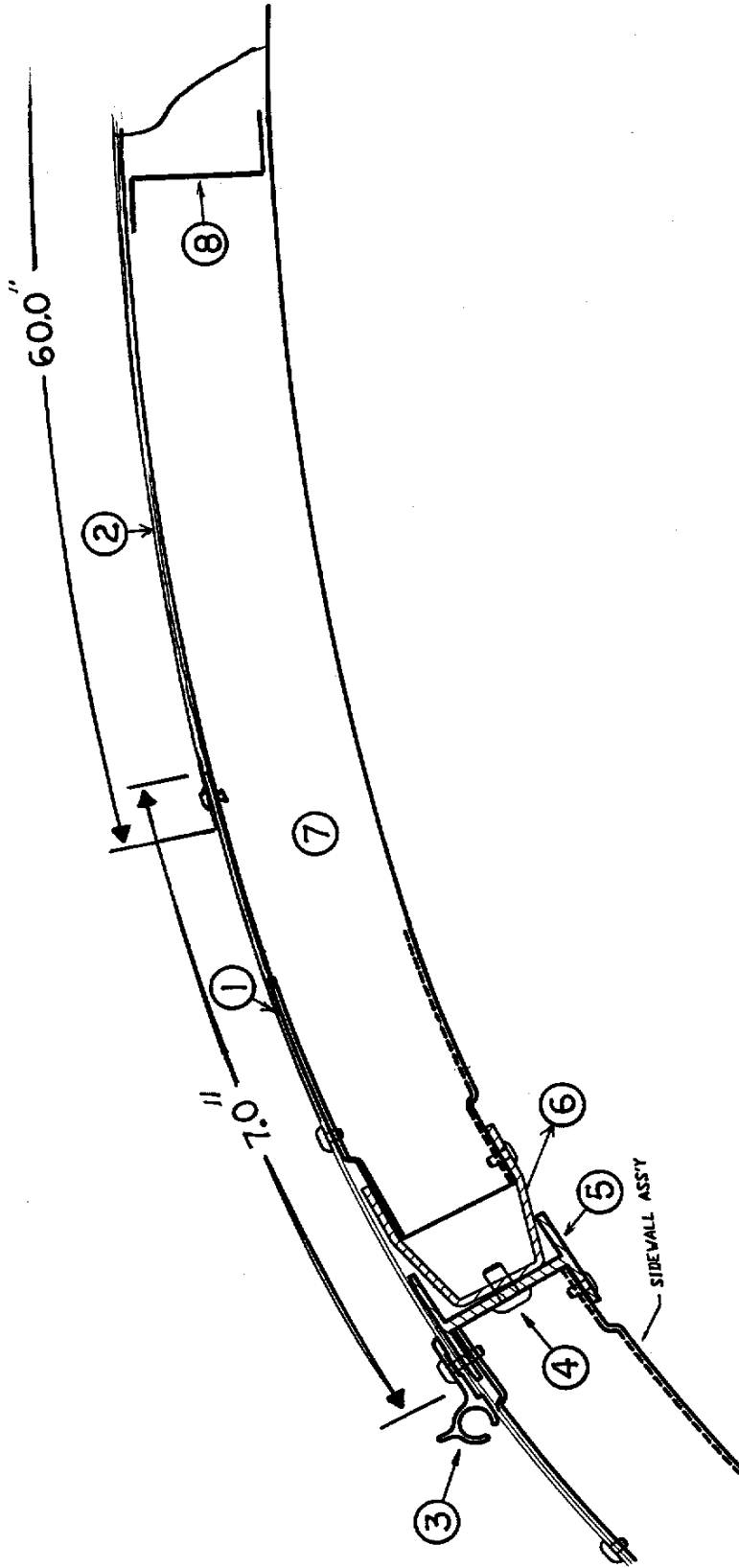

2000 BAMBI

BODY

ROOF-END VIEW

- | | |
|---------------|---|
| 1) 114362-318 | Alum. sheet, white, .050" x 7.0" x 318" |
| 2) 114489-259 | Alum. sheet, white, .032x60x259" |
| 3) 114290 | Extrusion, awning/drip rail |
| 4) 340123-02 | Rivet, Huck, 3/16" x 1/2" |
| 5) 104707-05 | Extrusion, "I" beam |
| 6) 114338 | Extrusion, roof corner |
| 7) 114387-03 | Roof bow |
| 8) 104408 | Extrusion, Z bar, horizontal |

2000 BAMBI

BODY, RS, 19FT. BAMBI

(Hardware such as hinges, locks and latches are located in the **hardware** section of this book)

- | | |
|---------------|---|
| 1) 114290 | Extrusion, awning/drip rail |
| 2) 114371 | Rib, end bow |
| 3) 104707-05 | Extrusion, "I" beam |
| 4) 114880 | Aluminum sheet, upper, .040" x 51" x 262" |
| 5) 371362-02 | Window, 19.25" x 22.75" |
| 6) 601194 | Water fill w/lock, gray |
| 7) 114328 | Extrusion, belt line |
| 8) 201912 | Molding, chrome, belt line |
| 9) 100034 | "Z" bar, 48" |
| 10) 114460 | Extrusion, rub rail |
| 11) 201763-01 | Insert, rub rail, chrome, 1" |
| 12) 100986 | Floor channel |
| 13) 114880 | Aluminum sheet, lower, .040" x 33" x 262" |
| 14) 114387-02 | Bow, Z rib, LH |
| 15) 114387-02 | Bow, Z rib, LH |
| 16) 100986 | Wheel well stiffener (floor channel) |
| 17) 684938 | Wheel well trim, inner, single axle |
| 18) 684939 | Wheel well trim, outer, single axle |
| 19) 101131-01 | Underbelly wrap, .024" x 22.5, pewter |
| 20) 104264 | Cover, 30# LPG bottles w/o decal |
| 21) 511017-11 | Vent cover, range exhaust |
| 22) 114466-01 | Casting, rub rail end, wheel well, RH |
| 23) 114466-02 | Casting, rub rail end, wheel well, LH |

2000 BAMBI

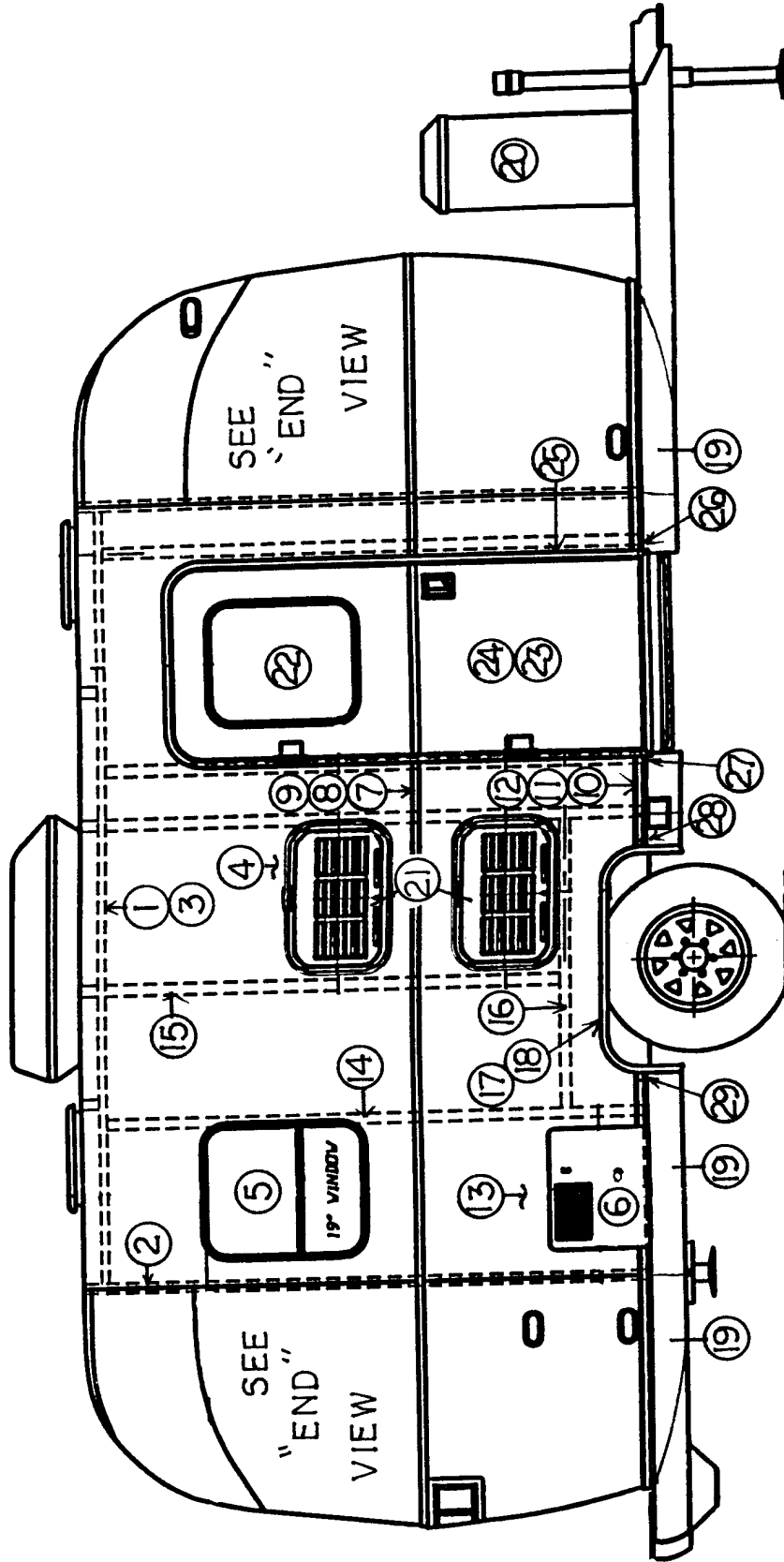

2000 BAMBI

BODY, CS, 19FT. BAMBI

(Hardware such as hinges, locks and latches are located in the **hardware** section of this book)

- | | |
|---------------|---|
| 1) 114290 | Extrusion, awning/drip rail |
| 2) 114371 | Rib, end bow |
| 3) 104707-05 | Extrusion, "I" beam |
| 4) 114880 | Aluminum sheet, upper, .040" x 51" x 262" |
| 5) 371362-02 | Window, 19.25" x 22.75" |
| 6) 690259-03 | Cover and mounting flange, Atwood |
| 7) 114328 | Extrusion, belt line |
| 8) 201912 | Molding, chrome, belt line |
| 9) 100034 | "Z" bar, 48" |
| 10) 114460 | Extrusion, rub rail |
| 11) 201763-01 | Insert, rub rail, chrome, 1" |
| 12) 100986 | Floor channel |
| 13) 114879 | Aluminum sheet, lower, .040" x 33" x 262" |
| 14) 114387-02 | Bow, Z rib, LH |
| 15) 114387-02 | Bow, Z rib, LH |
| 16) 100986 | Wheel well stiffener (floor channel) |
| 17) 684938 | Wheel well trim, inner, single axle |
| 18) 684939 | Wheel well trim, outer, single axle |
| 19) 101131-01 | Underbelly wrap, .024" x 22.5", pewter |
| 20) 104264 | Cover, 30# LPG bottles w/o decal |
| 21) 922243 | Door assembly, refrigerator assess |
| 22) 371362-01 | Window, main door |
| 23) 110067-01 | Main door assembly |
| 24) 114654 | Screen door assembly |
| 25) 114652 | Jamb, main door, preformed |
| 26) 114465-01 | Casting, rub rail end, door, RH |
| 27) 114465-02 | Casting, rub rail end, door, LH |
| 28) 114466-01 | Casting, rub rail end, wheel well, RH |
| 29) 114466-02 | Casting, rub rail end, wheel well, LH |

2000 BAMBI

BODY INTERIOR

964480-01	Roof locker & aft end liner
964479-01	Roof locker & forward end liner
114445	Aluminum sheet, .032" x 34"" x coil
114853-01	Aluminum sheet, .032" x 57"" x coil
702482-01	Wall liner, Geometric Pearl, 96"
702481*	Wall liner, Geometric Pearl Cream
114157-01	Extrusion, end liner, upper, white
201728-01	Extrusion, ceiling trim retainer
201728-03	Extrusion, ceiling trim
203225	Trim, flexible, "U", white
203138-01	Extrusion, plastic, wall, white
203138-02	Extrusion, plastic, wall, brown
101077	Extrusion, main doorjamb trim, interior
110460-01	Trim ring, window, 17.75" x 21.25"
110460-02	Trim ring, window, 19.25" x 22.75"
110460-08	Trim ring, window, 44.0" x 24.19"
110521-01	Trim ring, window, rear egress, 43.94" x 24.19"

*For repairs purchase vinyl glues locally.

2000 BAMBI

CHASSIS

7430001H	Axle, 4,000 lb.
0220003	Shock absorber
0250173-15	Bolt, grade 5, 5/8"-18 x 1.5", shock mount
0130068-818	Nut, hex head flanged, 5/8"-18, shock mount
410834	Tire and wheel assembly, 15", BSW, ST 225
410834-100	Aluminum wheel, 15" x 6, Safari/Bambi
400844	Dust cover, center hub, Aluminum
400923	Acorn lug nut
200844	Wheel well box, Bambi
201565	Tufcote, noise barrier, for wheel well
3320028	Jack, front, Atwood
453570	Stabilizer plate, front jack
410598	Foot pad
400914-01	Stabilizer jack, rear
400914-02	Handle, rear stabilizer jack
381416	Step, single, Elkhart#124
453618	Rear bumper, 3" x 78"
453497	Lid, rear hose carrier
453627	Bottom, rear hose carrier
380024	Support arm, hose carrier lid
380067	Hose carrier lid latch (Cam-o-lock)
381435	Hatch, access cover, 4", white (power cord)

(continued)

2000 BAMBI CHASSIS

0300027	Break away switch, Bargman
0360254H	Bracket, breakaway switch
450414	"A" frame spare tire carrier
114679	Aluminum underbelly, .019" x 65.75" x coil
101131-01	Aluminum, underbelly wrap, .024" x 22.5", gray

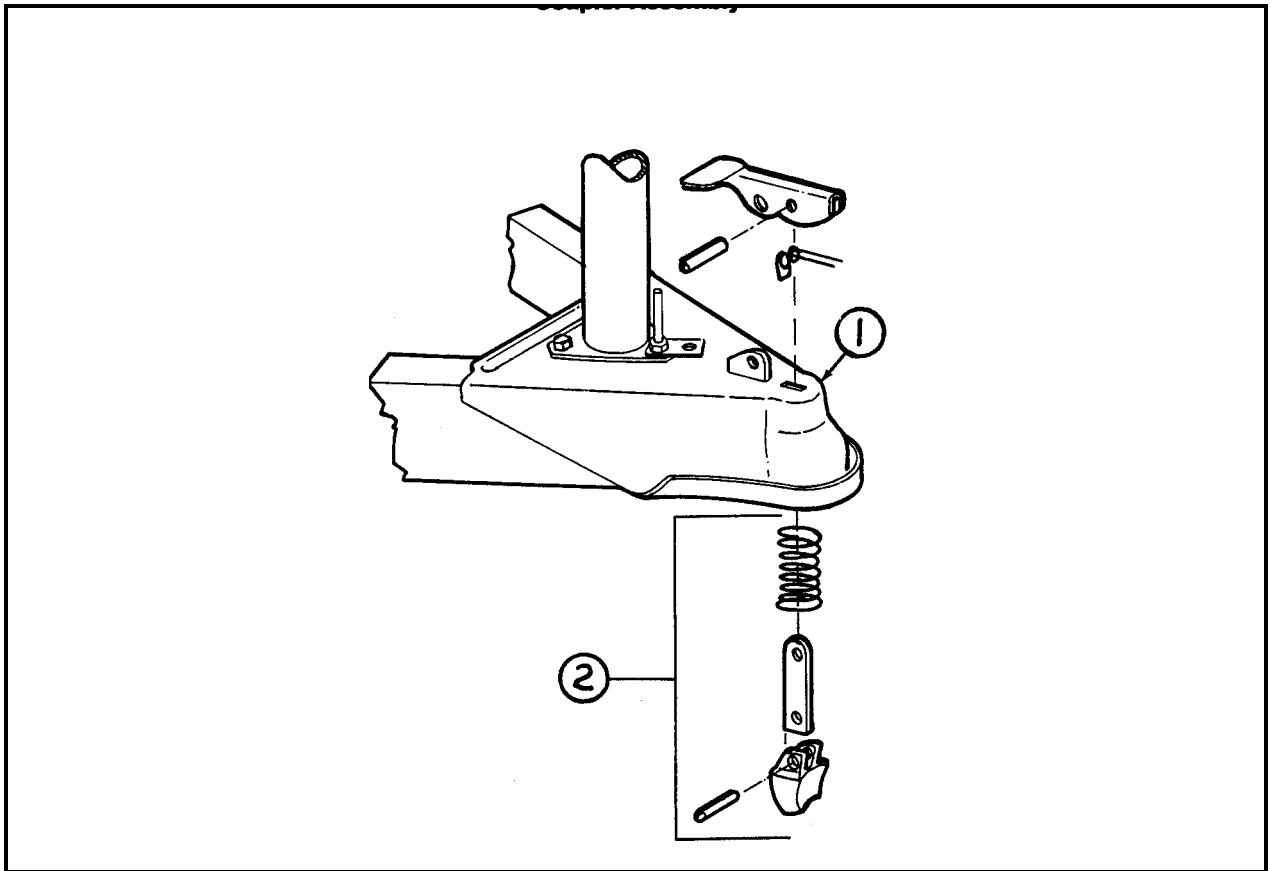

- 1) 680343 Coupler assembly, 2 5/16"
- 2) 680345 Repair kit, 2 5/16" coupler

(continued)

2000 BAMBI

CHASSIS

12" BRAKES, Bambi

3160121	Brake drum, 12", 6 lug
450659	Inner bearing, #25580
680364	Inner race, #25520
450658	Outer bearing, #LM67048
680365	Outer race, #LM67010
680370-100	Grease seal
3160347	Brake assembly, RH, 12" Dexter
3160348	Brake assembly, LH, 12" Dexter

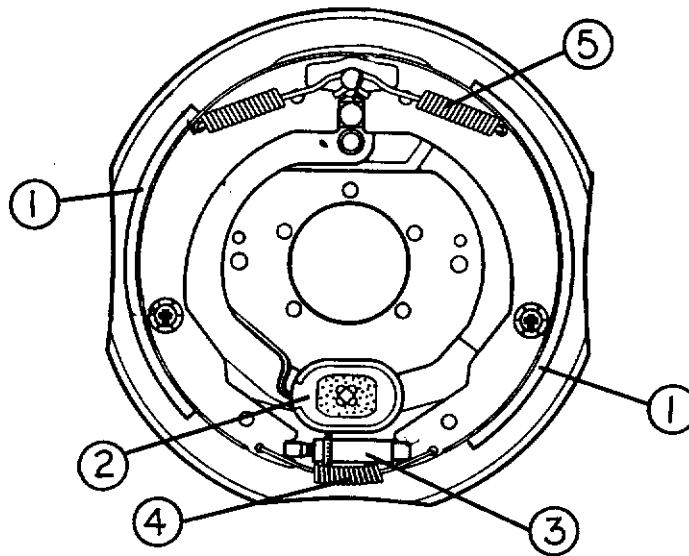

1) 3160348-62	Shoe and lining kit (includes hold down spring and pin)
2) 3160348-65	Magnet kit
3) 3160348-63	Adjuster assembly
4) 3160348-64	Adjusting screw spring
5) 3160348-61	Retractor spring

2000 BAMBI

SECTION II

D through E

DECALS/EXTERIOR TRIM II-1

DOORS/WINDOWS/AWNING

Doors..... II-2

Windows II-3

Awning..... II-3

DRAPES/BLINDS/VALANCES II-4

ELECTRICAL

110 volt II-5

12 volt II-6

ENTERTAINMENT

Radio/antenna..... II-8

2000 BAMBI

DECALS/EXTERIOR TRIM

386050	Decal, main stripe
386051	"Airstream" decal, above front and rear windows
386055	"Bambi" logo
386043-02	Medallion, AIRSTREAM, blue
114460	Extrusion, rub rail, 16'
201763-01	Insert, rub rail, chrome, 1"
114466-01	Close out, casting, rub rail, angled RH
114466-02	Close out, casting, rub rail, angled LH
114465-01	Close out, casting, rub rail RH
114465-02	Close out, casting, rub rail LH
114328	Extrusion, beltline
201912	Molding, chrome, beltline insert
114417	Casting close out, belt line

2000 BAMBI

DOORS/WINDOWS/AWNING

(Hardware such as hinges, locks and latches are located in the **hardware** section of this book.)

DOORS

110067-07	Main door assembly
114652	Jamb, main door, preformed
114653	Frame, main door, preformed
114448-02	Skin, exterior, upper main door
114449-02	Skin, exterior, lower main door
114475	Skin, inner, vinyl clad
114363	Drip cap, main door
365232	Seal, main door
101077	Extrusion, inside doorjamb trim
114654	Screen door assembly
114561	Panel, slider, screen door
203000-01	Close out, plastic, screen door
380079	Screen, gray
200518	Spline, gray, screen insert
365013	Gasket, screen door, foam tape
922243	Door, refrigerator access
104417	Jamb, refrigerator access door
104439	Louvered panel, refrigerator access door
203225	Trim, flexible, white access door jamb edging
100679	Side access door assembly
365035	Seal, side access door
601194	Water fill w/lock, gray
690209	Access cover, Atwood water heater

(continued)

2000 BAMBI

DOORS/WINDOWS/AWNINGS

(Hardware such as hinges, locks and latches are located in the **hardware** section of this book.)

WINDOWS

371362-01	Window, 17.75" x 21.25"
371362-02	Window, 19.25" x 22.75"
371362-10	Window, 43.94" x 24.19"
371362-11	Window, egress, Bambi, 43.94" x 24.19"

AWNINGS

110102-02	Rock guard, Bambi
685351	Rubber frame, black
683960	Arm support
683959	Arm support bracket
685354	Front window key
702993-04	Awning, patio, 9' 8", Zip Dee
702993	Hardware package, Zip Dee

2000 BAMBI

DRAPES/BLINDS/VALANCES

110554 Curtain set, Bambi

702355-01 Shade, roller type, 20 1/8" x 36" galley

964515-02 Valance assembly, RS, front, 64"

964515-01 Valance assembly, CS, front

964518 Valance assembly, CS bedroom

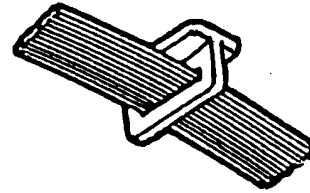

101220
Bracket, curtain
stand off

101217 Track, and curtain
700044 Glides, w/elastic
"T" type

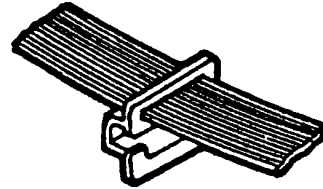

114021
Bracket, curtain
stand off

101225
Bracket, curtain
stand off

700045
Glides, w/elastic
"G" type

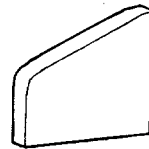
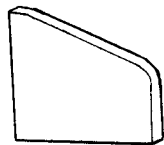

200785
End, curtain track, LH

200784
End, curtain track, RH

2000 BAMBI

ELECTRICAL

110 VOLT

510634	Power cord, 36ft.
511041	Breaker box, Westinghouse
510564-05	Breaker 30-20, Bryant
510564-04	Breaker 20-20, Bryant
510564-20	Breaker, 20 GFI
510564-07	Breaker 15 GFI, Bryant
500563-01	Receptacle, 15 amp, white
511287	Receptacle, 15 amp, single
510676-01	Outlet, exterior, gray
511023	Circuit tester (loose item)
511426	Converter, 55 amp

2000 BAMBI

ELECTRICAL

12 VOLT

511132	Battery, deep cycle, lead acid
511386	Battery box
340023	Latch, Corbin, battery box
453603	Strap, battery box, Bambi
500886	7-Way cable w/plug
0300027	Break away switch, Bargman
511426	Converter, 55 amp
510626	Switch, master disconnect
510627	Face plate, disconnect switch
511337	Fuse block, 12 volt, 6 position-ATC type
511248	Light, 12 volt, incandescent, single, interior
511249	Light, 12 volt, incandescent, double, interior
510781	Detector, smoke
511309	Detector, LPG
511341-02	Monitor panel, wall mount
502056	Mounting plate, 12 volt switch
511327	Switch body w/rocker, single, white
510868-03	Switch panel, 4 gang, white, by door
511100-01	Switch body w/rocker, white
511077-03	Cover, switch, white w/gold print
510807	Outlet, 12 volt
511121	Mounting plate, 12 volt receptacle

(continued)

2000 BAMBI

ELECTRICAL

12 VOLT

500996	Jack, TV/phone, gray
510654-01	TV jack/12 volt w/splitter, white
510624-01	Modular phone quick jack, white
104619	Mounting plate, exterior telephone/TV jack

EXTERIOR LIGHTS/REFLECTORS

510732	Utility light (by door)
500500	Tail light assembly
510161	Can, #1156 bulb and socket
510160	Can, #1157 bulb and socket
510162	Tail light lens
510163	Back-up light lens
380226	Gasket, tail light lens
201462	Pocket , plastic, taillight
109172	Bezel, chrome, tail light
510111	Clearance light, red, Signal Stat
510112	Clearance light, amber, Signal Stat
500095	Reflector, red, rectangular
500096	Reflector, amber, rectangular
510446	Reflector, red, stick-on w/chrome edge
510163	Reflector, red, 3"
500053	License plate light w/plate mounting bracket

2000 BAMBI ENTERTAINMENT

511498	Radio, AM/FM/Cassette, Sony, XR 790
511048	Speaker, 40 Watt, Coustic HS 402
511499	CD changer, 10 unit, Sony CDX 424RF (opt.)
510610	Antenna, radio, side mount
510788-01	TV antenna, Winegard #RV-7004
510788-03	Amplifier, TV antenna
510613	Coax, 75-ohm w/three conductors
510623	Connector, coax, male to male
114396	Trough, TV antenna
510788-04	Hardware package, interior, Winegard

2000 BAMBI

SECTION III

F through H

FASTENERS (common fasteners available locally are not listed)

Rivets III-1

FLOOR COVERING

Carpet III-3

Mats III-3

FURNITURE

Interior doors III-4

Mirrors III-4

Drawer III-4

Rear bedroom III-5

Bath III-5

Galley III-6

Lounge III-6

HARDWARE

Exterior locks/hinges III-7

Interior drawer slides/hinges latches III-11

Bath accessories III-14

Awing hardware III-16

2000 BAMBI

*FASTENERS



325043
Rivet, buck type
dia. 1/8"
length 1/4"
(hard)



325000-01
Rivet, buck type
dia. 1/8"
length 1/4"
anodized clear



325000-03
Rivet, buck type
dia. 1/8"
length 1/4"
anodized white



325001-01
Rivet, buck type
dia. 1/8"
length 5/16"
anodized clear



325002-01
Rivet, buck type
dia. 1/8"
length 3/8"
anodized clear



325004-01
Rivet, buck type
dia. 1/8"
length 1/2"
anodized clear

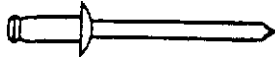

330127-03
dia. 1/8"
grip range .063-.125
aluminum body
aluminum mandrel



300101
1/8" I.D.
washer, aluminum

*Common bolts and screws readily available at local hardware outlets have not been listed.

2000 BAMBI

*FASTENERS

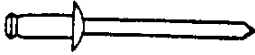

330126-02
rivet, pop
dia. 1/8
grip range .126-.187
stainless steel body
stainless steel mandrel

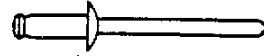

330126-03
rivet, pop
"dia. 1/8 "
grip range .126-.250
stainless steel body
stainless steel mandrel



330127-050
rivet, pop
dia. 1/8"
grip range .251-.312
aluminum body
aluminum mandrel

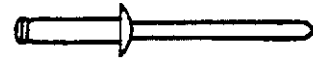

330128-05
rivet, pop
dia. 1/8"
grip range .251-.312
aluminum body, white
aluminum mandrel



330127-080
rivet, pop
dia. 1/8"
grip range .325-.565
aluminum body
aluminum mandrel

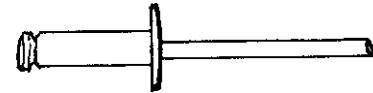

330038
rivet, pop
dia. .150 (#20 bit)
grip range .126-.250
aluminum body
aluminum mandrel
(used-screen door hinge)



325103
dia. 1/4"
grip range .080-.325
S S body
steel mandrel

*Common bolts and
screws not listed.

2000 BAMBI FLOOR COVERING

702794-01 Carpet, Spectrum, Pike Green

700173 Pad, carpet, 3/8" thick

381346 Floor mats

703037 Flooring, laminate, bath, Capisto Sand 15.5" x 15.5

801291 Trim, laminate floor

**2000 BAMBI
FURNITURE
WARDROBE/CABINET DOORS**

Width" x height (inches)

"

964385-17	Door	9.13" x 24.0"
964385-18	Door	13.25" x 62.0"
964385-21	Door	15.63" x 11.88"
964385-06	Door	17.75" x 13.75"
964385-28	Door	19.62" x 30.50"
964385-04	Door	23.00" x 8.00"
964385-03	Door	23.50" x 4.5"
964385-19	Door	24.88" x 10.5"
964385-16	Door, breaker box cover,	7.5" x 13.75

ROOF LOCKER DOORS

964386-02	Door, roof locker, front and rear-RH&LH,	12.5"
964386-08	Face panel, locker end filler, spec., RH or LH	
964386-06	Door, roof locker,	32.5"
964503-02	Door, bedroom roof locker,	14" x 41.0"
964386-03	Door, galley roof locker,	28.38"
964386-07	Door, galley roof locker,	15.5x 24.88"

MISCELLANEOUS DOORS

702937-03	Shower door, roll away	36" x 62"
964539	Bath door assembly,	25.5" x 72
372203-02	Mirror, safety glass, medicine cab.	19.5x20"
372203-05	Mirror, safety glass, medicine cabinet,	19" x 14
702681-04	Door, foldette,	56" x 73"
381563-01	Track formed, foldette door	
701342-01	Strap, vinyl, foldette door	

DRAWERS

201016	Drawer, plastic,	16" x 22"
962821-61	Drawer box,	2.88" x 16.0" x 20.0"
962821-27	Drawer box,	5.00" x 18.0" x 17.50

2000 BAMBI

FURNITURE

BEDROOM

108433	Header , foldette door
200003	End cap, header mounting, brown
702681-04	Door, foldette, 56" x 73"
452258	Bracket, mounting, foldette door
701342-01	Strap, vinyl, foldette door

964481	Bed assembly
964250-01	Wardrobe assembly, RS, Bambi
964505	Roof locker, bedroom
381241	TV shelf

BATHROOM

(see hardware section for fixtures-if connected to water,
see plumbing)

203114	Shower, two piece fiberglass
203138-01	Extrusion, wall, plastic, white
702937-03	Shower door, roll away, 36" x 62"
801192-12	Divider panel, bath

801209-004	Doorjamb, bath
964312	Header, bath door

964249-02	Lavatory cabinet assembly
964315	Top, lavatory cabinet

964318	Medicine cabinet, upper
964319	Medicine cabinet, lower

2000 BAMBI

FURNITURE

GALLEY

964482-01	Galley assembly
964483	Top, galley assembly
381615	Tray, plastic, 11"
963990	Magazine rack
961982-01	Sink cover
964514	Spice cabinet assembly
964490	Galley roof locker assembly
964460	Refrigerator cabinet assembly
964461	Top, refrigerator cabinet assembly
511341-01	Range hood

LOUNGE AREA

964484	Dinette seat assembly, RS
964485	Dinette seat assembly, CS
964486	Dinette table assembly
962177-02	Leg, hardwood, 28.50"

2000 BAMBI

HARDWARE

MAIN DOOR LOCK

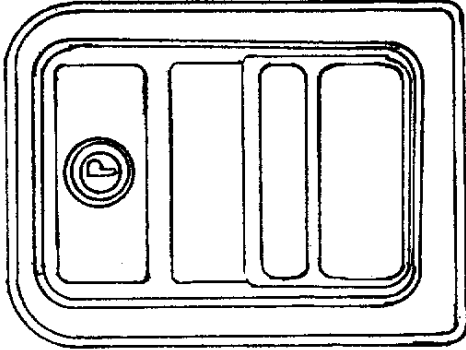

381547-01
Main door lock, outside
Housing

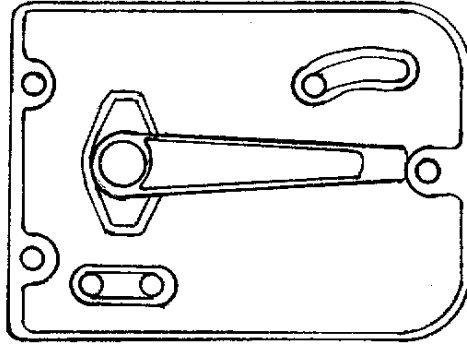

381547-02
Main door lock, inside
plate

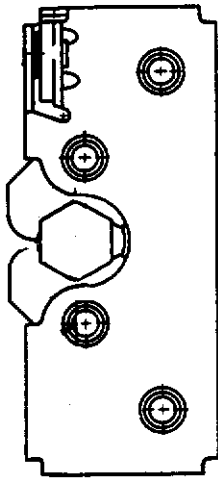

381547-0
Double rotary latch,
main door lock

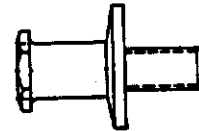

3381547-04
Striker bolt w/washer
main door lock

Not shown:

381547-05 Screw package, main door lock

2000 BAMBI
 HARDWARE
 EXTERIOR LATCHES/LOCKS

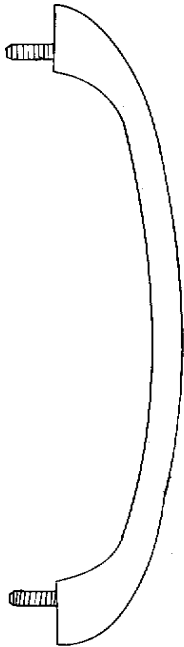

101171
 Grab handle, main door

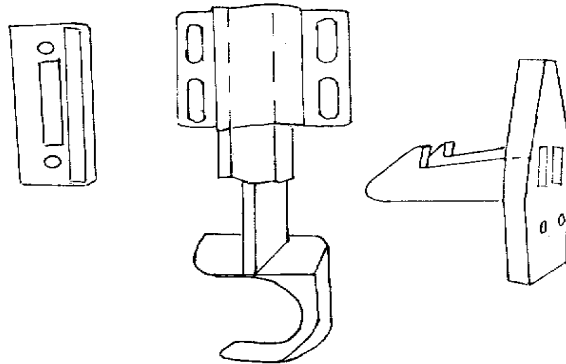

381454
 Latch, screen door, Bullet

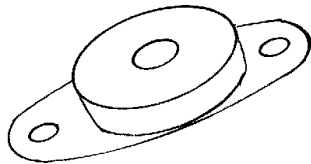

685359
 Rubber receptacle
 1/4" latch, Southco

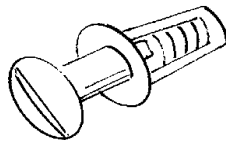

685342
 Stud, 1/4" turn latch
 Southco



685362
 Retaining ring
 1/4" turn stud

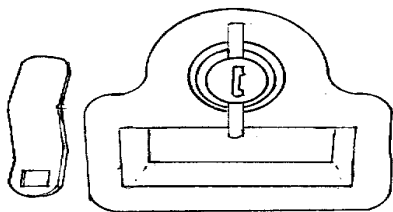

380770-101 Twist lock, chrome
 380770-102 Twist lock, black

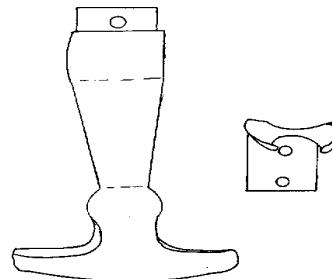

381021 Rubber T handle

2000 BAMBI HARDWARE

EXTERIOR LATCHES/LOCKS

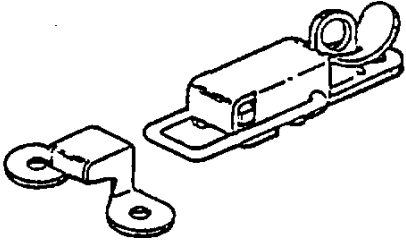

340023 Corbin catch
w/strike, battery box



380067 Lock cam,
bumper lid

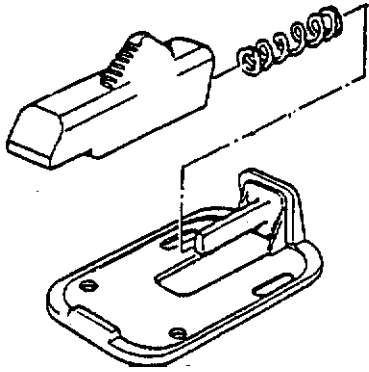

380291 Main door holdback,
(use w/housing #380290)

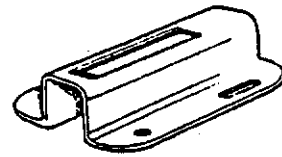

380290 Latch housing,
main door holdback

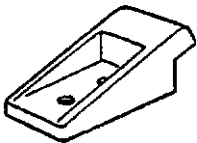

201056 Catch, main door
Holdback

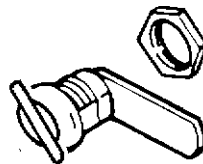

381513 Twist lock
refer. access door

2000 BAMBI

HARDWARE

EXTERIOR LATCHES/LOCKS

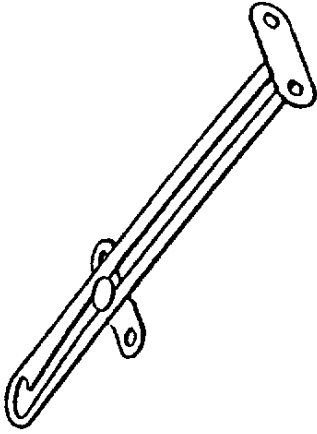

380024 Support arm,
bumper lid

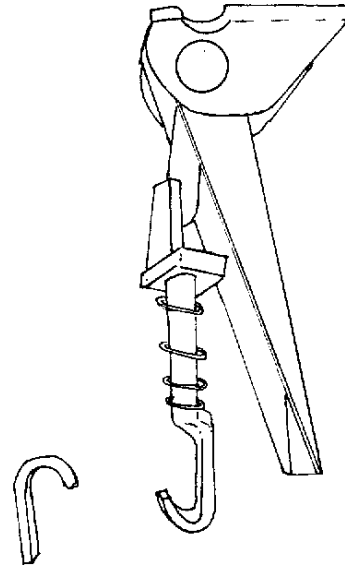

380903 Latch w/strike,
chrome, gas bottle cover

EXTERIOR HINGES

381552-03 Hinge assembly, main door, upper
381552-04 Hinge assembly, main door, lower

381531-01 Hinge, screen door, upper
381531-02 Hinge, screen door, lower

380773 Hinge, access door, 13 1/4"
385935-01 Hinge, pivot, trunk door, rear

380203-01 Piano hinge, 1/8" pin, clear anodized, hose
carrier lid

2000 BAMBI HARDWARE

INTERIOR LATCHES/HINGES

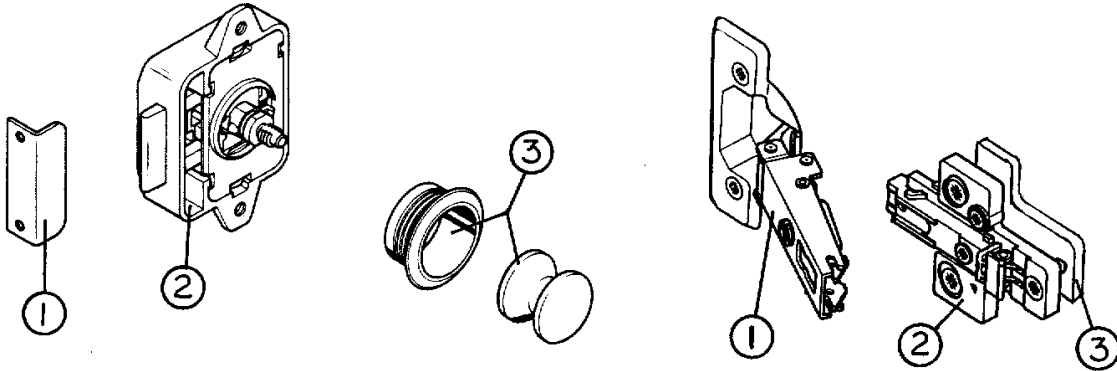

- 1) 381608-07 Strike plate, rim lock
- 2) 381608-02 Latch, cabinet, rim lock
- 3) 381608-03 Push button w/rosette

- 1) 381607-01 Hinge, cabinet
- 2) 381607-02 Base, metal
- 3) *381607-03 Base, plastic

*Not used in all applications

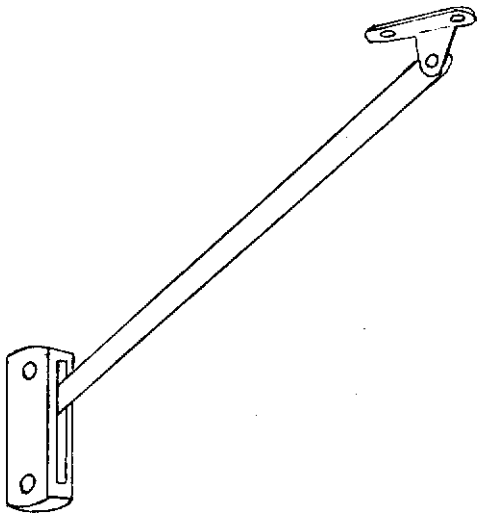

- 381608-04 Support arm, roof locker, RH
- 381608-05 Support arm, roof locker, LH

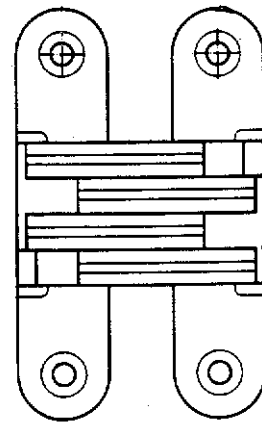

- 380040 Soss hinge, lift up table

2000 BAMBI

HARDWARE

INTERIOR LATCHES/HINGES

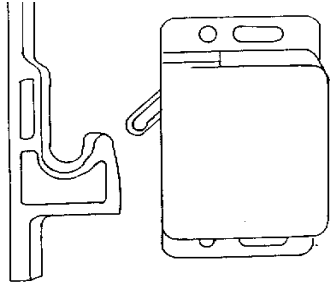

381228 Grabber door latch w/catch, 10lb.rating
381228-01 Grabber door latch w/catch, 3lb. rating



381228-100 Catch only, grabber door latch

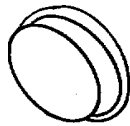

201427 Finger pull, light brown



381603 Pull, three finger
Antique brass



381599 Handle, drawer/door

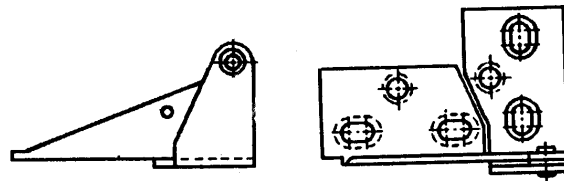

385935-01 Hinge pivot, zinc plated

2000 BAMBI

HARDWARE

INTERIOR LATCHES/HINGES



360012 Bumper, rubber
white, stick-on, cylindrical

360012-01 Bumper, rubber
brown, stick-on, cylindrical

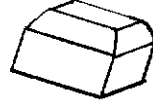

360016 Bumper rubber
gray, square 3/8" x 3/8"



195329-220 Bumper, rubber
clear, stick-on oval



385587 Cap, rubber
hood bumper, black

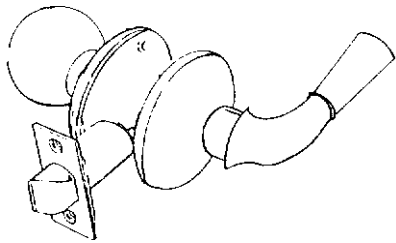

381022 Latch, swinging
bath door

2000 BAMBI
HARDWARE
BATHROOM ACCESSORIES

380034	Toilet paper holder, chrome
381259-01	Towel bar, 18", chrome
380259-03	Brackets, chrome towel bar
380248	Soap dish
380017	Holder, tumbler and toothbrush

HINGES

381607	Hinge assembly, Euro style, Grass
380458	Hinge, piano, 3/32" pin, 5/8" leaf, brown
380210	Hinge, 2" metal, bed top
385935-01	Hinge, pivot, plated, medicine chest
381614	Folding shelf bracket, galley
381072	Hinge, 3 in. x1 7/8" in. open, gold

WARDROBE

380045	Clothes rod
200975-04	Conduit, flexible, black (covers clothes rod)
380046	Bracket, clothes rod

MICSELLANEOUS

701342-01	Vinyl strap, sliding door hold back (female snap on both ends)
381526-01	Drawer slide -950-RV, 14"
701624	Velcro loop, 5/8" wide
701625	Velcro hook, 5/8" wide

2000 BAMBI

NOTES:

2000 BAMBI

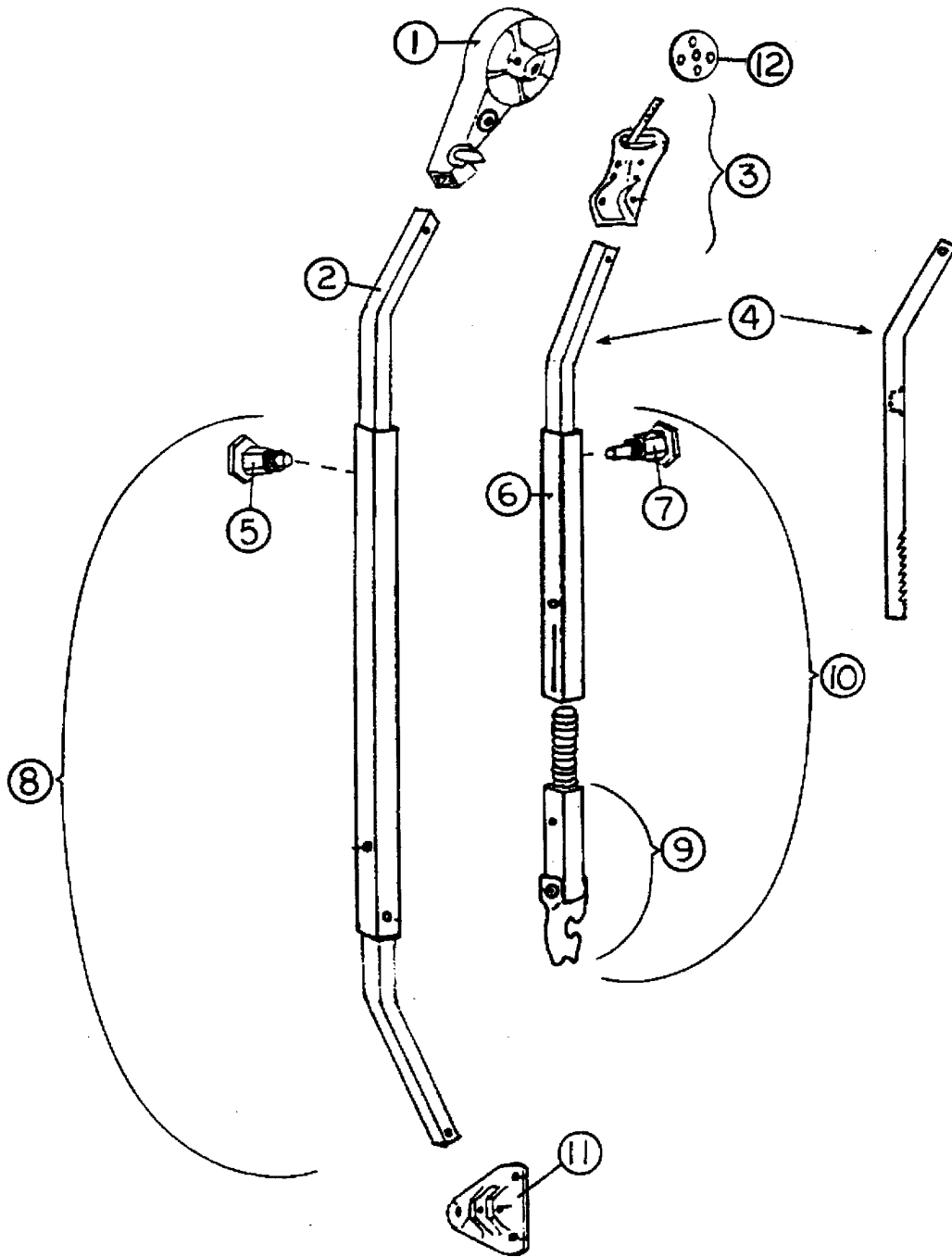

2000 BAMBI

HARDWARE

AWNING HARDWARE

- | | |
|----------------|---------------------------------------|
| 1) 702662-100 | Head assembly, front or rear |
| 2) 702662-101 | Main arm bar, front or rear |
| 3) 702622-103 | Clamp assembly, front, curved |
| 3a) 702662-104 | Clamp assembly, rear, curved |
| 4) 702662-105 | Rafter arm bar, satin |
| 5) 702662-106 | Snap stud assembly |
| 6) 702662-107 | Rafter arm tube, satin |
| 7) 74072W | Ratchet stud |
| 8) 74048W | Main arm tube assembly, front or rear |
| 9) 702662-110 | Claw bar assembly |
| 10) 702662-111 | Rafter arm assembly |
| 11) 702662-112 | Base hinge, rib mount |
| 12) 702662-114 | Clamp wheel |

2000 BAMBI

SECTION IV

L through Z

LABELS and TAGS IV-1

PLUMBING

LPG IV-2

Fresh water IV-3

Drain water..... IV-8

Toilet IV-12

SAFETY EQUIPMENT IV-14

SEALER/GASKETS/PAINT IV-15

UPHOLSTERY/FOAM/MATTRESS IV-16

VENTS/FANS IV-17

WOOD/LAMINATES/TRIM IV-18

2000 BAMBI LABELS AND TAGS

385193	Label, "12V distribution panel inside"
385048	Label, approval with shield
385269	Label, "DON'T USE AREA FOR STORAGE"
385068	Tag, cooking appliance warning
385067	Label, EXIT
385547	Label, LP gas warning/fill
385517	Label, kill switch warning
385521	Label, emergency egress window
385463	Warning label/cooking appliance
385464	Label, LP gas warning label(odor)
385465	Exit label, English
385560	Label, air conditioner rating
385512	Label, Calif. hazardous substance
385609	Label, smoke detector
385359	Label, microwave or air conditioner
385837	Label, refrigeration ignition
385103	Plate, RVIA
385418-01	Label, Federal registration
385062	Decal, 110-125 voltage AC
385565	Label, holding tank flushing
385972	Label, fuse 12volt

2000 BAMBI

PLUMBING

LPG SYSTEM

601710-01	LP gas bottle, 30lb. steel,
601686	Base plate, LP tank mounting
601687	Hold down kit, LP tank
601731	LP regulator, Marshall Brass w/pigtails, mounting bracket & cover
601731-100	LP pigtails, 15in.
601685-01	LP hose, 1/2 FPT" x 3/8 F, 36"
601684-101	Bracket, mounting, LP regulator
601684-102	Cover, Marshall Brass regulator
600468	Union flare, 5/8" x 5/8"
600238	Union flare, 3/8" x 3/8"
600004	Copper tubing, 5/8"
600008	Copper tubing, 3/8"
600436	Flare nut, forged, 5/8"
600435	Flare nut , forged, 3/8"
600000	Tee, brass, 5/8" x 5/8" x 3/8"
104264	Gas bottle cover w/o decal
380903	Latch and strike
200841	Lid, plastic, bottle cover
380773	Hinge, access door

2000 BAMBI

PLUMBING FRESH WATER

601194	Water fill w/lock, gray
601708-01	Tank, fresh water
601239	Tubing, 1.375 I.D., flexible, water fill hose
601061-03	Water pump, Shurflo
600668	Filter, pre water pump
601588	Drain cock, brass, water line drain

CITY WATER

600139	Check valve, brass
600362	Connector, 1/2FPT" x water hose, swivel
600336	Plug with chain
601690	Nipple, 1/2 MPT" x 2.50
601689	Drop ell, 90 degree, 1/2 FPT
600309	Regulator, Watts, 1/2 FPT
601469	Vacuum breaker, 3/4in. garden hose
601467	Sill cock, 1/2in.female

FITTINGS

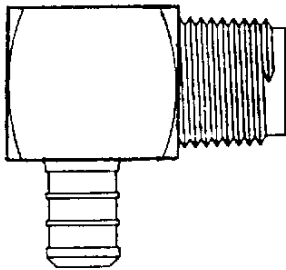

601698-04
Elbow, 1/2" barb
" x 1/2" MPT

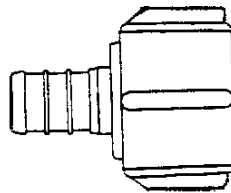

601698-03
Coupler, 1/2" barb
x 1/2" FPT

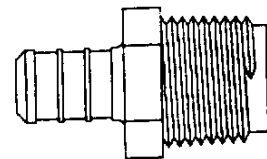

601698-02
Coupler, 1/2" barb
x 1/2" MPT

(continued)

2000 BAMBI
PLUMBING
FRESH WATER-FITTINGS

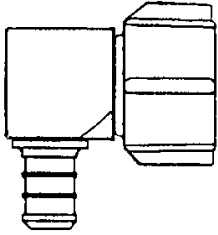

601698-05
Elbow 1/2" barb x
1/2" FPT

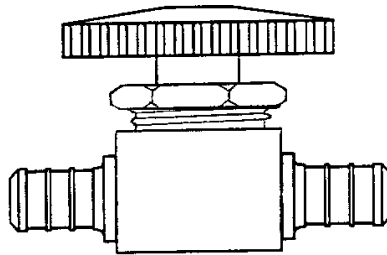

601698-07
Shut-off, 1/2" barb x
1/2" barb

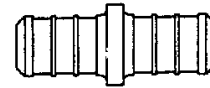

601698-08
Coupler
1/2" x 1/2" barb

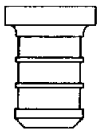

601698-09
Plug, 1/2" barb

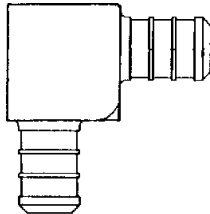

601698-10
Elbow 1/2" barb x
1/2" barb

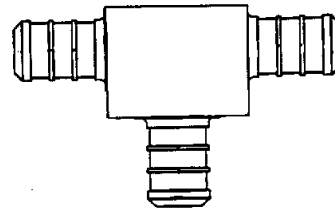

601698-11
Tee, 1/2" x 1/2" x
1/2" barb



601698-15
Crimp ring, 1/2
E-Pex, 1/2" (black)

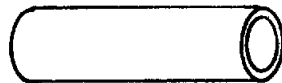

601698-01
E-Pex tube, 1/2"

2000 BAMBI

PLUMBING

FRESH WATER FAUCETS

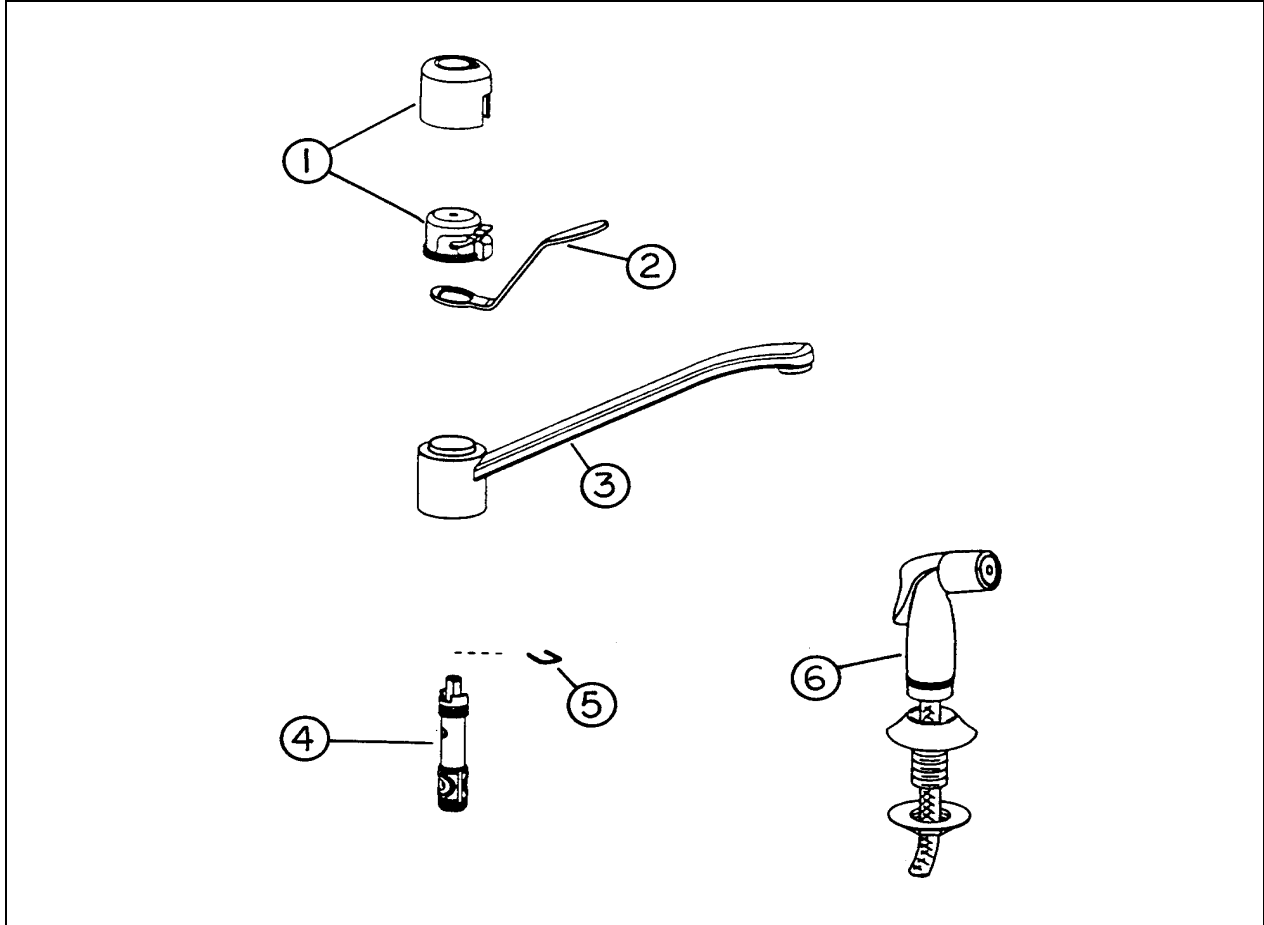

601746 Galley faucet, Moen Manor

- | | |
|---------------|------------------------------------|
| 1) 013098 | Galley lever handle set, Moen |
| 2) 601746-100 | Lever handle, Moen |
| 3) 601746-101 | Spout assembly, 9" Moen |
| 4) 601579-106 | Cartridge, Moen #1225 |
| 5) 601579-105 | Horseshoe clip, cartridge retainer |
| 6) 601418-100 | Spray head and hose, Moen |

2000 BAMBI
PLUMBING
FRESH WATER FAUCETS

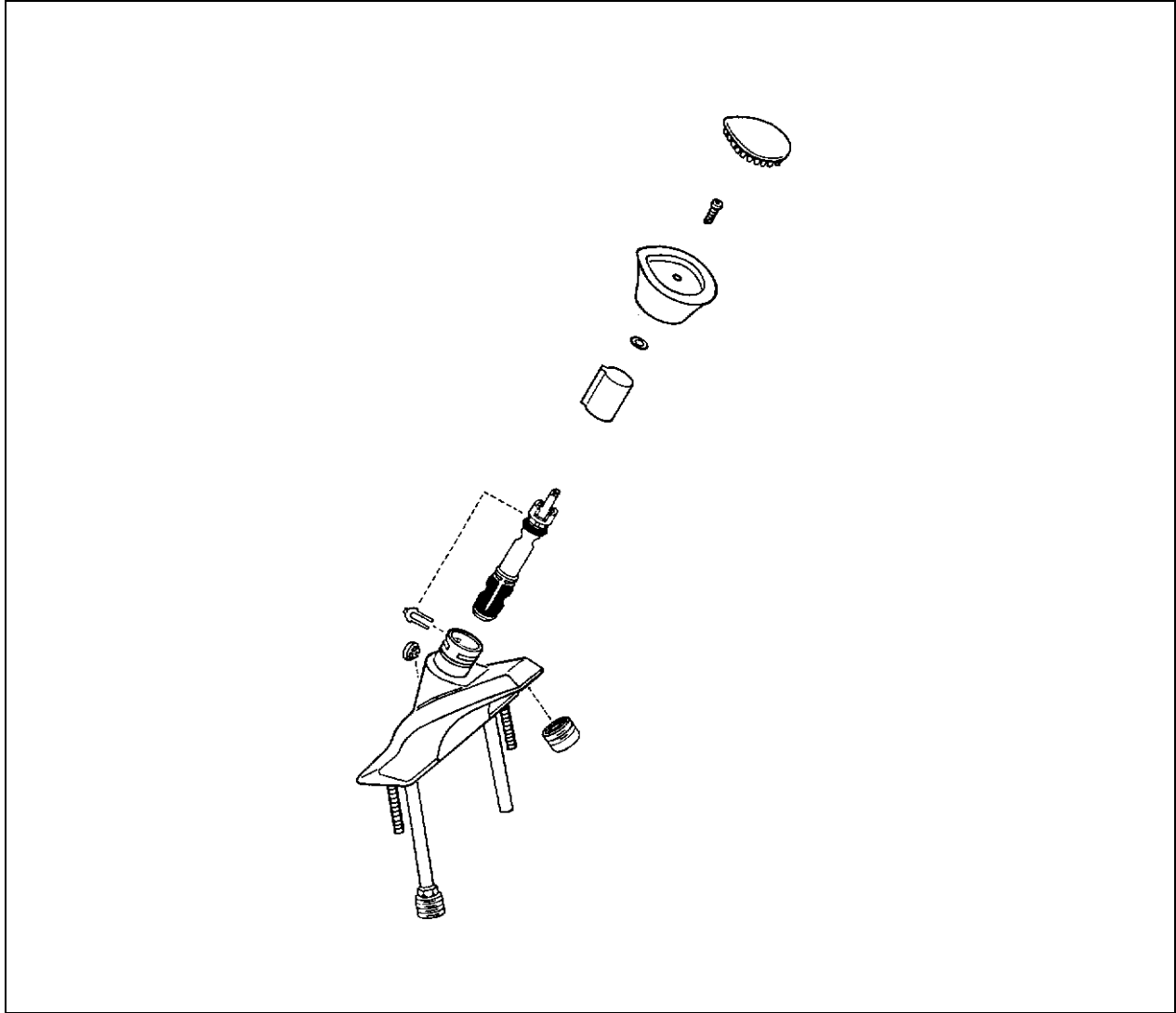

601419-01 Faucet, lavatory, Moen, chrome

- 1) 001245 Knob
- 2) 601579-105 Cartridge
- 3) 601579-104 Retainer clip

2000 BAMBI
PLUMBING
FRESH WATER-FAUCETS

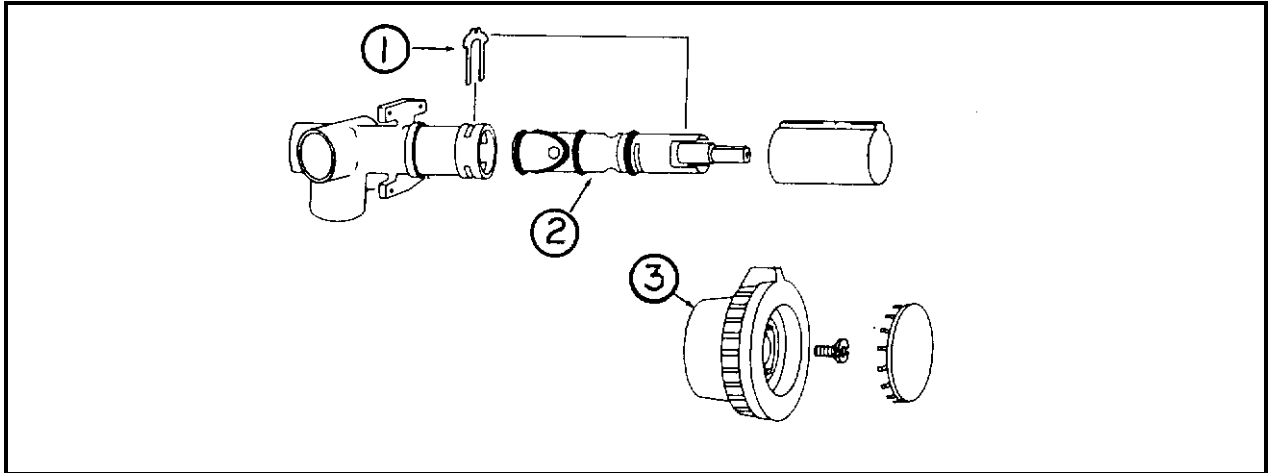

601420-01Faucet, shower

- | | |
|---------------|---------------|
| 1) 000883 | Retainer clip |
| 2) 601420-100 | Cartridge |
| 3) 001041 | Handle |

Not shown:

601358 Shower kit, includes: shower hose, showerhead,
vacuum breaker and wall
mounts

2000 BAMBI

PLUMBING DRAIN SYSTEM Gray tank

601707-01 Holding tank, gray, Bambi
601717 Pan, gray tank

Black Tank

601706-01 Holding tank, black, Bambi
601482 Dump valve assembly, Bambi
600183 3" Ell, long sweep

Sink/Showers

203114 Shower stall, two piece, Bambi
600594 Tub strainer w/rubber stopper
601715-01 Sink, porcelain, galley
195362-39 Strainer, 2"
200406-06 Lavatory bowl, oval (includes stopper, basket and tail)

1 1/2" DRAIN FITTINGS

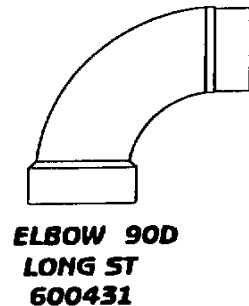
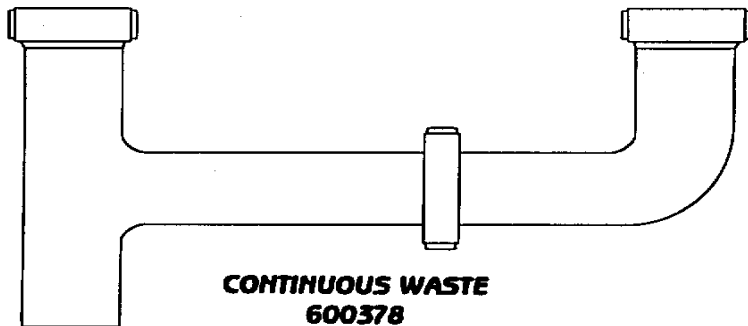

2000 BAMBI
PLUMBING
DRAIN FITTINGS, 1.5"

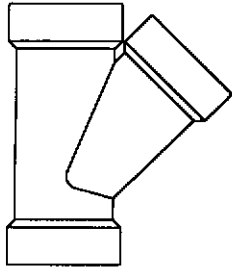

**WYE
#2301
600094**

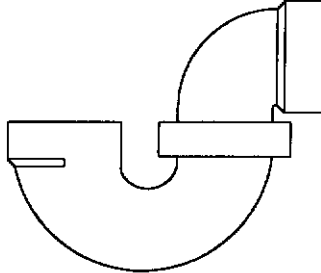

**P-TRAP
1.5\"/>W/O SLIP NUT
600144**

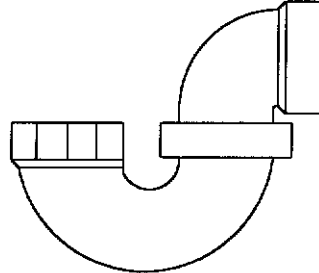

**P-TRAP
1.5\"/>WITH SLIP NUT
600622**

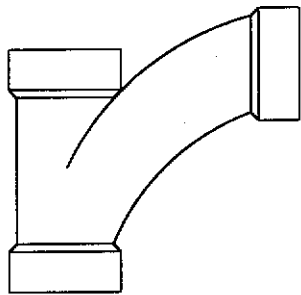

**WYE 1.5\"/>
1/8\"/> BEND
600182**

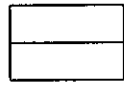

**COUPLING
1.5\"/>
600227**

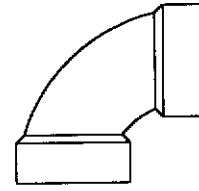

**ELBOW 90D
SHORT SWEEP
601636**

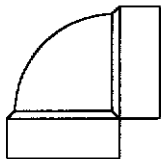

**ELBOW VENT
90D
600033**

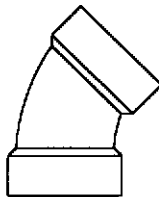

**ELBOW 45D
LONG TURN
600030**

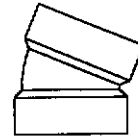

**ELBOW 22.5D
SHORT TURN
600116**

(continued)

2000 BAMBI
PLUMBING
FITTINGS, 1.5" PLASTIC

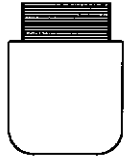

VENT 1.5"
600538



PLUG 1.5"
600155



CAP 1.5"
601677

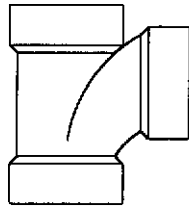

TEE-SANITARY
1.5"
600156

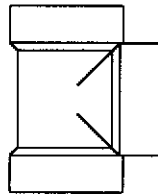

TEE-BI DIRECTIONAL
CLEAN-OUT 1.5"
601318

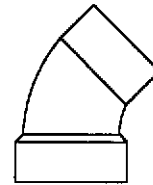

ELBOW 45D
LONG ST
600027

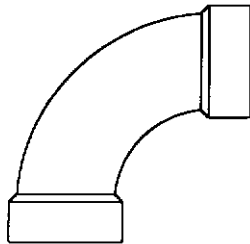

ELBOW 90D
LONG TURN
600035

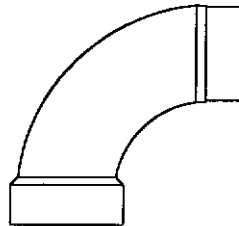

ELBOW 90D
LONG ST
600431

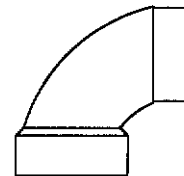

ELBOW 90D
SHORT ST
600662



REDUCER 1.5" TO 1.25"
601263



ADAPTER
601676

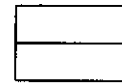

ADAPTER
W/FEMALE THREADS
600308

2000 BAMBI

NOTES:

2000 BAMBI
PLUMBING
THETFORD, AQUA MAGIC IV, FOOT FLUSH, WHITE

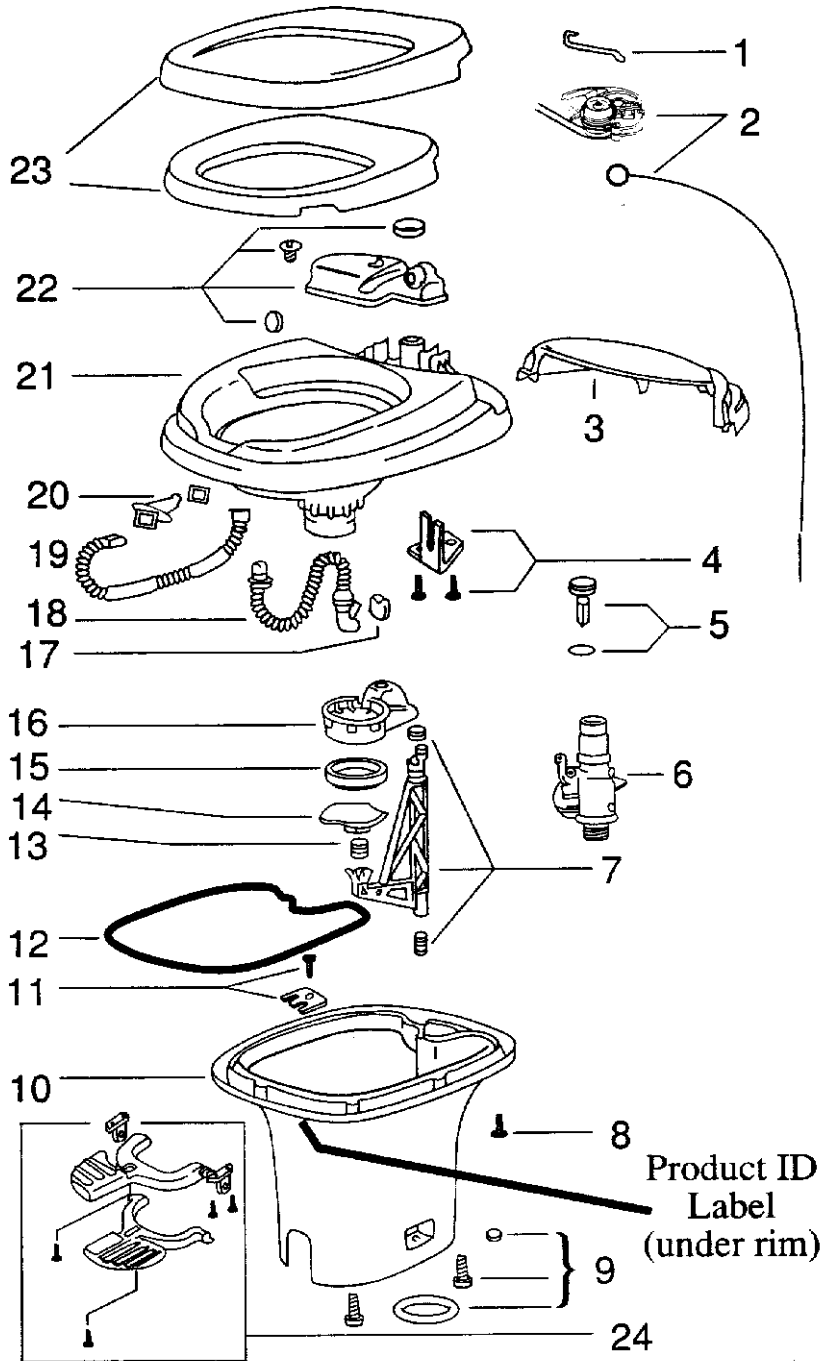

2000 BAMBI

PLUMBING

THETFORD, AQUA MAGIC IV, FOOT FLUSH, WHITE

690387 Toilet complete, Aqua Magic IV, low

- 1) 690327-513 Water valve link
- 2) 690327-571 Wire replacement package
- 3) 690327-562 Mechanism cover, white
- 4) 690327-634 Bracket assembly
- 5) 690327-631 Float assembly
- 6) 690327-168 Water valve replacement package
- 7) 690327-632 Actuator assembly
- 8) 690327-659 Screw base to bowl
- 9) 690327-524 Closet bolt package
- 10) 690327-356 Base, white, low
- 11) 690327-636 Retainer assembly
- 12) 690327-387 Sealant, base to bowl
- 13) 690327-519 Blade spring
- 14) 690327-262 Blade
- 15) 690327-481 Blade seal
- 16) 690327-520 Blade track
- 17) 690327-512 Flapper
- 18) 690327-511 Overflow tube
- 19) 690327-509 Flush tube
- 20) 690327-637 Nozzle assembly
- 21) 690327-726 Bowl
- 22) 690327-630 Reservoir tank assembly
- 23) 690327-162 Seat and cover assembly
- 24) 690327-821 Pedal package

2000 BAMBI

SAFETY EQUIPMENT

510781	Smoke detector
511309	LPG detector
600162-01	Fire extinguisher

2000 BAMBI

SEALER/GASKETS/PAINT

SEALER

6000360	Sealant, Butyl #884058
360074	Sealant, white, 3 oz. tube
360001	Sealant, #884058
360002	Sealant, Vulkem 11.5 oz. tube
360209	Sealant, seam
360176	Sealant, Almond, kitchen and bath
360180-04	Sealant, Sikaflex #221, black, tube
360210	Sealant, Paralastic 4334-014
360283	Sealant, silicone, Corian Bone

GASKETS



365035 Gasket
access doorjamb



365013 Gasket
screen door



365232 Gasket
main door



371593-711 Glazing
rubber, Creation
window



371593-713 Seal
plastic, sash
Creation window



371593-712
Foam seal, sash
Creation window

381665 Gasket, D seal, window frame to shell

380226 Gasket, taillight lens

380114 Gasket, vent pipe

365016 Tape, foam, double face, 1/2" wide

365001-02 Tape, vinyl foam, double face, 3/4" wide

380222 Tape, acrylic foam, double face, 3/4" wide

360151 Paint, gray metallic Centari #44146A

360200-01 Hardener, Centari

360213 Paint, Aluminum metallic, Centari #65751

360260 Paint, Pewter

2000 BAMBI

UPHOLSTERY/FOAM/MATTRESS REAR BEDROOM

702905	Mattress, double, 48" x 76", Bambi
702704	Mattress, double, 52" x 75", 23&25ft."C"
*702904-337	Bedspread, Bambi, Cabin Creek
701611	Pillow, 21" x 31, all models

FRONT DINETTE, BAMBI

998070-03	Cover, seat, side dinette
998071-03	Cover, backside dinette
702464-16	Foam, dinette upper back
702464-13	Foam, dinette lower back
702933-01	Foam, dinette seat, LH
702933-02	Foam, dinette seat, RH

*Changing the -(dash) number to:

118= Cypress Gardens
128= Starlight
159= Kodiak
169= Rain Forest

2000 BAMBI

VENTS/FANS

690394	Power ventilator, refrigerator, Bambi
109067	Vent pipe cover, cast aluminum
380114	Gasket, vent pipe
381606-01	Vent, roof, 14" x 14", non-power, white
381606-02	Trim ring, interior, roof vent, white
690266-01	Ventilator, power, bath
511341-01	Range hood
511017-11	Vent cover, exterior, range hood, gray
100341	Vent collar, refrigerator, large
101394	Cover, refrigerator vent, large

2000 BAMBI

WOOD/LAMINATES/TRIM PLYWOOD

800506-04	Plywood, 1/2" x 4" x 8'
800976-01	Plywood, tongue and groove, 19/32'(floor)
800506-05	Plywood, 5/8" x 4" x 8'
800583	Plywood, Birch Baltes(cutting boards) 5/8x5x5
801068-06	Plywood, G2S, 3/4" x 4" x 8'

PANELING

800507-02	Panel, Lauan, 1/4" x 4" x 8', raw/raw
800507-03	Panel, Lauan, 3/8" x 4" x 8', raw/raw
801191-004	Panel, G1S, 1/8" x 4" x 8', Oak vinyl
801261	Panel, G1S, 1/8" x 4" x 8', Antiquity Buff
801181-004	Panel, G1S, 5/32" x 4" x 8', Oak/raw
801182-004	Panel, G2S, 5/32" x 4" x 8', Oak/Oak
801283	Panel, G2S, 1/2" x 4" x 8', Antiquity Buff/Ant. Buff
801179-004	Panel, G1S, 1/2" x 4" x 8', Oak/raw
801274	Panel, G1S, 1/2" x 4" x 8', Antiquity Buff
801180-004	Panel, G2S, 1/2" x 4" x 8', Oak/Oak
801203-004	Panel, G2S, 1/2" x 4" x 8', Oak 6mil
801183-004	Panel, G2S, 1/2" x 4" x 8', Oak/Antiquity Buff
365251-01	Tape, seam, Antiquity Buff, 1 1/8" wide
365251-02	Tape, seam, Antiquity Buff, 8" wide
365251-03	Tape, seam, Antiquity Buff, 12" wide

(continued)

2000 BAMBI

WOOD/LAMINATES/TRIM

LAMINATES

801229	Laminate, Oak, high pressure, .045-.050
801169	Laminate, Beige Pampas, .042 (galley top color)
801230	Pre-laminated panel, Oak, 5/8"x4x8, lauan core
801212-01	Pre-laminated panel, Beige Pampas, 5/8"x4x8
801184-01	Laminated lumber core, .75" x 1.5" x 8ft.
801184-03	Laminated lumber core, .75" x 2.0" x 8ft.
801184-07	Laminated lumber core, .75" x 3 square
801184-04	Laminated lumber core, .75" x 2 radius

TRIM

801195	Corner trim, 1" radius
800766	Trim, hardwood, .50 groove" x 8', panel edging
800405	Plug, hardwood button, screw cover

2000 BAMBI
WOOD/LAMINATES/TRIM

TRIM

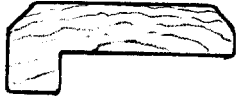

800617-014 Molding
Wainscoat, oak

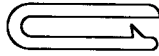

203225 Trim
lock, white



201728-03 Extrusion
plastic, ceiling trim, wh.

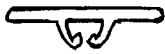

201728-01 Extrusion
ceiling trim retainer



203159-02 Trim,
divider bar

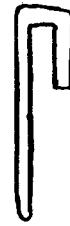

201666 Molding, "J"
trim, plastic



203138-01 Extrusion,
panel edging, white
203138-02 Extrusion,
panel edging, brown

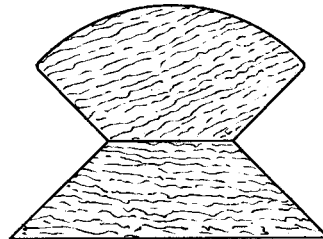

801282-004 Corner trim
1"radius