

***AIRSTREAM***

**30' & 33'  
LAND YACHT  
GAS**

**Parts Book**

**1998**

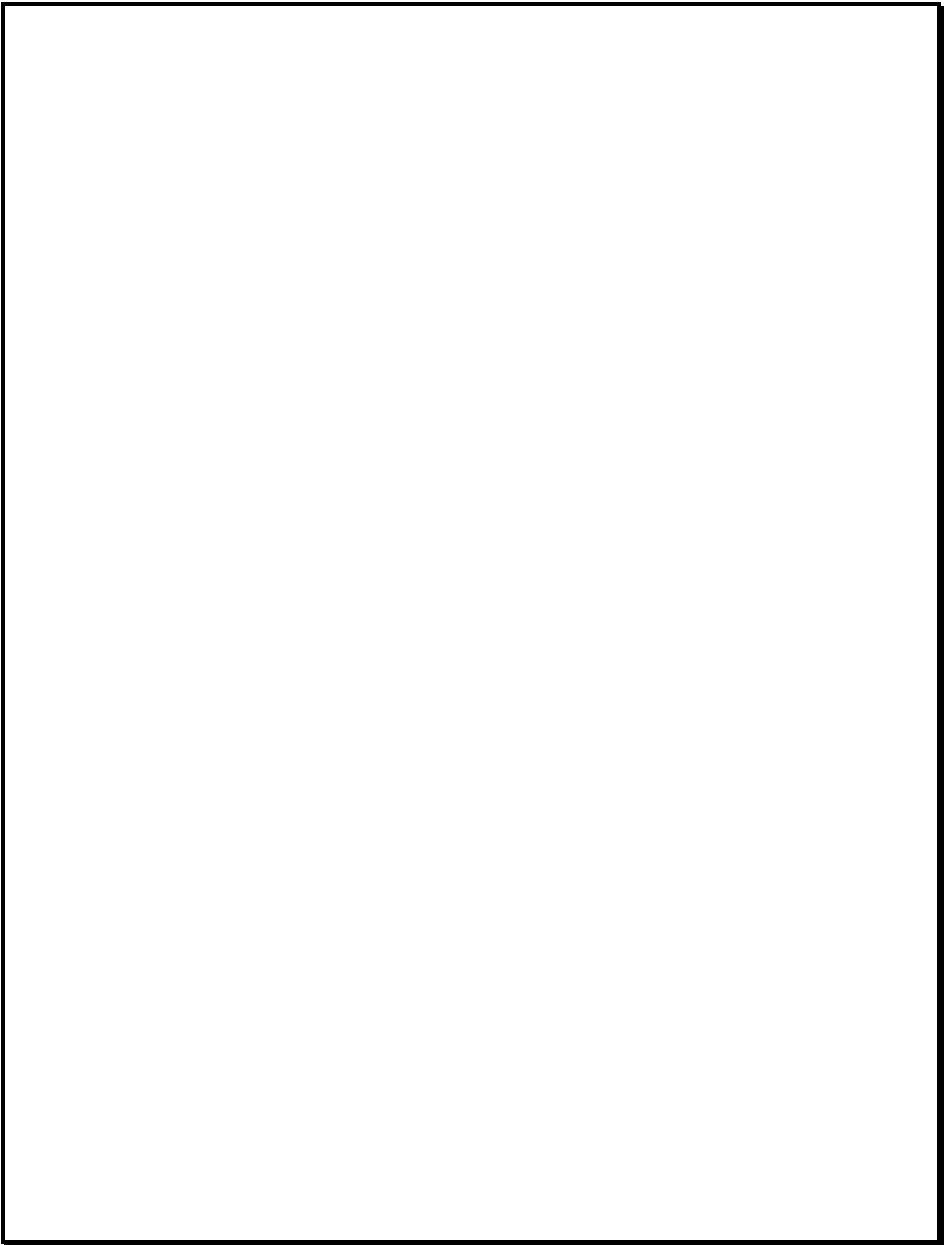

# TABLE OF CONTENTS 1998 30' & 33'

## SECTION I A through C

### APPLIANCES

<a href="#">Air conditioner</a> .....	I-1
<a href="#">Furnace</a> .....	I-1
<a href="#">Microwave</a> .....	I-1
<a href="#">Range</a> .....	I-2
<a href="#">Refrigerator</a> .....	I-2
<a href="#">Water heater</a> .....	I-3

### BODY

<a href="#">30ft.CS wall</a> .....	I-7
<a href="#">30ft.RS wall</a> .....	I-9
<a href="#">33ft.CS wall</a> .....	I-11
<a href="#">33ft.RS wall</a> .....	I-13
<a href="#">Roof</a> .....	I-14
<a href="#">Front end</a> .....	I-16
<a href="#">Aft end</a> .....	I-18

### CHASSIS

<a href="#">Hitch</a> .....	I-21
<a href="#">Power jacks</a> .....	I-21
<a href="#">Step</a> .....	I-21
<a href="#">Auxiliary heater</a> .....	I-21
<a href="#">Spare tire bracket</a> .....	I-21
<a href="#">Automotive air conditioner</a> .....	I-22

# TABLE OF CONTENTS 1998 LY 30' & 33'

## SECTION II

### D through E

#### DASH

<a href="#">Dash parts</a> .....	II-1
<a href="#">Glove box</a> .....	II-1
<a href="#">Trims</a> .....	II-1
<a href="#">Defrost nozzle</a> .....	II-1
<a href="#">Rear view mirror/interior/exterior</a> .....	II-1
<a href="#">Sun visors</a> .....	II-1
<a href="#">Windshield wiper</a> .....	is II-2

<a href="#">DECALS</a> .....	II-7
------------------------------	------

#### DOORS/WINDOWS/AWNINGS

<a href="#">33ft.RS</a> .....	II-11
<a href="#">33ft.CS</a> .....	II-13
<a href="#">30ft.RS</a> .....	II-15
<a href="#">30ft.CS</a> .....	II-17

<a href="#">DRAPES/BLINDS/VALANCES</a> .....	II-19
--	-------

#### ELECTRICAL

<a href="#">110 volt</a> .....	II-21
<a href="#">12-volt chassis</a> .....	II-23
<a href="#">12-volt exterior lights</a> .....	II-24
<a href="#">Dash switches/lens</a> .....	II-25
<a href="#">Interior 12-volt</a> .....	II-27

#### ENTERTAINMENT

<a href="#">Televisions/Video/Antennas</a> .....	II-29
<a href="#">Radios</a> .....	II-29

# TABLE OF CONTENTS 1998 30' & 33'

## SECTION III F through H

FASTENERS (common fasteners available locally are not listed)

<a href="#">Rivets</a> .....	III-1
<a href="#">Screws</a> .....	III-3

### FLOOR COVERING

<a href="#">Carpet</a> .....	III-5
<a href="#">Hardwood flooring</a> .....	III-5
<a href="#">Mats</a> .....	III-5

### FURNITURE

<a href="#">Interior doors</a> .....	III-7
<a href="#">Mirrors</a> .....	III-7
<a href="#">Drawer face</a> .....	III-8
<a href="#">Drawer box</a> .....	III-8
<a href="#">Bedroom furniture</a> .....	III-9
<a href="#">Bath, 30ft.</a> .....	III-11
<a href="#">Bath, 33ft.</a> .....	III-12
<a href="#">Galley, 30ft.</a> .....	III-13
<a href="#">Galley, 33ft.</a> .....	III-15
<a href="#">Lounge/cab, 30ft.</a> .....	III-17
<a href="#">Lounge/cab, 33ft.</a> .....	III-19

### HARDWARE

<a href="#">Exterior compartment</a> .....	III-21
<a href="#">Main/Drivers door</a> .....	III-21
<a href="#">Interior drawer slides/hinges/catches</a> .....	III-24
<a href="#">Bath accessories</a> .....	III-25
<a href="#">Awning hardware</a> .....	III-27

# TABLE OF CONTENTS 1998 LY 30' & 33'

## SECTION IV L through Z

<a href="#">LABELS and TAGS</a> .....	IV-1
---------------------------------------	------

<a href="#">OPTIONS</a> .....	IV-3
-------------------------------	------

### PLUMBING

<a href="#">LPG</a> .....	IV-5
---------------------------	------

<a href="#">Fresh water</a> .....	IV-6
-----------------------------------	------

<a href="#">Faucets</a> .....	IV-8
-------------------------------	------

<a href="#">Drain water/Tanks/Pipes/Fittings</a> .....	IV-12
--	-------

<a href="#">Toilet</a> .....	IV-15
------------------------------	-------

<a href="#">SAFETY EQUIPMENT</a> .....	IV-17
--	-------

### SEALS/SEALER/PAINT

<a href="#">Gaskets</a> .....	IV-19
-------------------------------	-------

<a href="#">Sealer</a> .....	IV-23
------------------------------	-------

<a href="#">Adhesive</a> .....	IV-24
--------------------------------	-------

<a href="#">Paint</a> .....	IV-24
-----------------------------	-------

### UPHOLSTERY/FOAM/MATTRESS

<a href="#">Mattresses</a> .....	IV-25
----------------------------------	-------

<a href="#">Bed spread/Pillow kits/Sofa</a> .....	IV-25
---	-------

<a href="#">Cab/Swivel seat</a> .....	IV-25
---------------------------------------	-------

<a href="#">Dinette foam/upholstery, 30ft/33Ft.</a> .....	IV-26
---	-------

### VENTS/FANS

<a href="#">Skylights/Vents/Fans</a> .....	IV-27
--	-------

### WOOD/LAMINATES/INTERIOR TRIM

<a href="#">Paneling Wood accessories</a> .....	IV-29
---	-------

<a href="#">Wood molding/trim</a> .....	IV-30
---	-------

<a href="#">Ceiling trim/retainer</a> .....	IV-31
---	-------

# TABLE OF CONTENTS 1998 30' & 33'

## SECTION I A through C

### APPLIANCES

Air conditioner .....	I-1
Furnace .....	I-1
Micro-wave .....	I-1
Range .....	I-2
Refrigerator.....	I-2
Water heater .....	I-3

### BODY

30ft.CS wall .....	I-7
30ft.RS wall .....	I-9
33ft.CS wall .....	I-11
33ft.RS wall .....	I-13
Roof .....	I-14
Front end.....	I-16
Aft end .....	I-18

### CHASSIS

Hitch .....	I-21
Power jacks.....	I-21
Step .....	I-21
Auxiliary heater .....	I-21
Spare tire bracket .....	I-21
Automotive air conditioner.....	I-22





# 1998 LAND YACHT 30' & 33'

## APPLIANCES

### DUO THERM AIR CONDITIONER (800-366-3842)

690323-02	Air conditioner, Dometic, 13, 500, manual
690323-03	Air conditioner, Dometic, 11, 000, manual
690323-05	Air box/return grill, manual
690323-100	Shroud, air conditioner, Penquin
385582-01	Decal, Airstream w/bar
510514	Switch, priority, 3 way, ivory
500385C	over, priority switch, ivory

### FURNACE, HYDROFLAME (800-825-4328) -Dealer only

690274	Furnace, Hydroflame, #8535-35, 000BTU
690244-06	Mounting flange
690274-06	Door exterior, Hydroflame
601244-03	Register.rotaire, black
600969-01	Grille, 6x4, col. white
600678	Adapter, grill, heat duct10x2
600247	4" duct hose, flexible

### MICROWAVE, MITO (800-433-6486)

690383-01	Microwave oven, Mito
690383-02	Trim kit, Microwave oven

# 1998 LAND YACHT 30' & 33'

## APPLIANCES

### MAGIC CHEF RANGE

(800-544-5513)

690348	Range top, 3 burner
690347	Range, 3-burner w/oven
690012-01	Range cover, bi-fold
964383-01	Range covers, Corian, set

### DOMETIC REFRIGERATOR, RM3862R

(800-366-3842)

690370-01	Refrigerator, 2-way, RH, RM3862R
801225-01	Door panel, upper, oak, 15.5 x 20.31"
801225-03	Door panel, lower, oak, 38.38 x 20.31
690370-100	Cooling unit, RM3862
381207-03	Vent, roof, Dometic, polar white

(Continued)

# 1998 LAND YACHT 30' & 33'

## APPLIANCES

ATWOOD WATER HEATER, GH6-8E  
(800-825-4328) Dealer only

690225	Water heater, Atwood, elec. ignition w/motor aid
500933	Switch, water heater, electronic
690259-03	Cover/mounting flange, Atwood

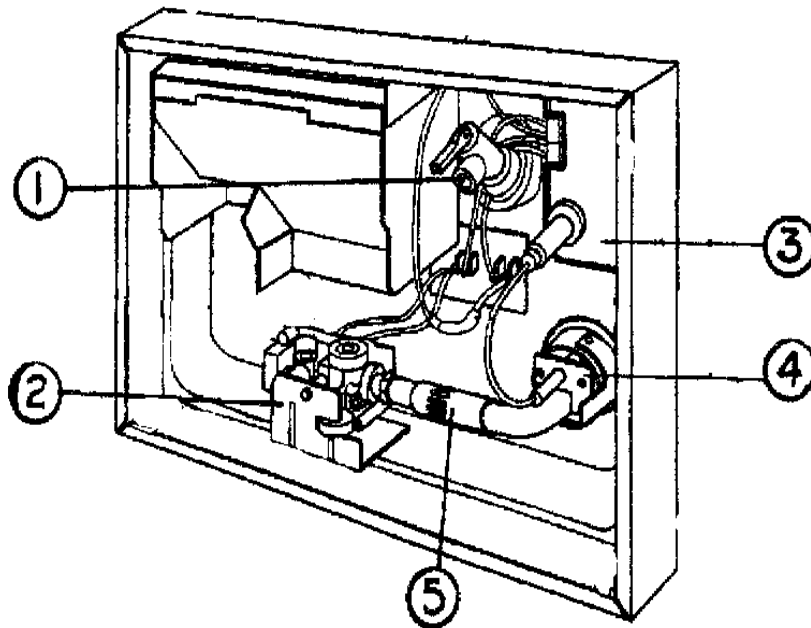

1) 091604	Relief valve, pressure/temperature
2) 093870	Solenoid valve
3) 093865	Circuit board
4) 093868	Spark probe
5) 092615	Main burner

# 1998 LAND YACHT 30' & 33'

## NOTES

# 1998 LAND YACHT 30' & 33'

## BODY

THIS SECTION SHOWS SIDEWALLS AND LOWER BODY PANELS MOST FREQUENTLY DAMAGED IN MINOR ACCIDENTS.

THE LOWER COMPARTMENT DOORS, ACCESS DOORS, AND WINDOWS ARE SHOWN IN THE DOOR SECTION OF THIS BOOK.

# 1998 LAND YACHT 30' & 33'

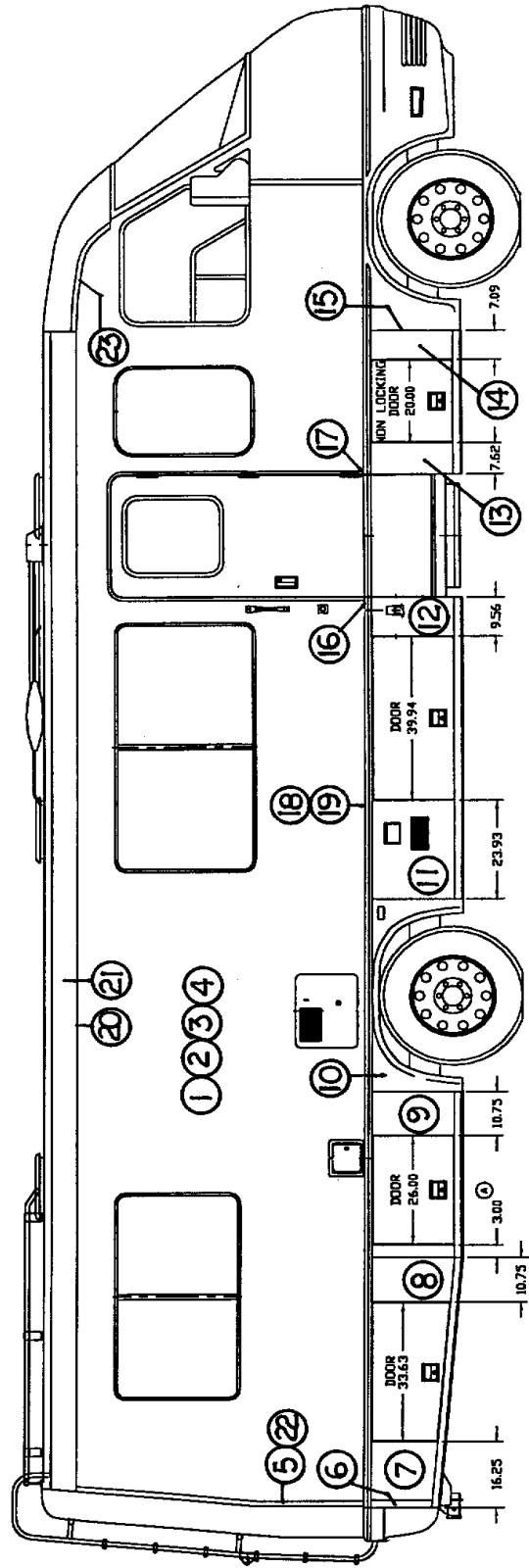

## 1998 LAND YACHT 30' & 33'

### \*BODY, CURB SIDE WALL **30' ONLY**

- |               |  |
|---------------|--|
| 1) 801002-01  | Fiberglass sheet, frost white, 72"x332"    |
| 2) 915361     | Weldment, roadside wall, 30'               |
| 3) 203075     | Styrofoam sheet, 1 1/2" thick              |
| 4) 801176-03  | Paneling, inside 1/8x4'x7', G1S, Solitude  |
| 5) 114005-02  | Trim molding, ends to sidewall             |
| 6) 114005-03  | Extrusion, trim lower cap to filler panel  |
| 7) 114585-15  | Filler panel, 16.25"                       |
| 8) 114586-04  | Filler panel, 10.75"                       |
| 9) 114586-04  | Filler panel, 10.75"                       |
| 10) 201805    | Fender skirt                               |
| 11) 114585-09 | Filler panel, 23.93"                       |
| 12) 114587-03 | Filler panel, 9.56", Dbl. Flange           |
| 13) 114587-10 | Filler panel, 7.62"                        |
| 14) 114587-16 | Filler panel, 8.00"(over size, cut to fit) |
| 15) 114070-02 | Extrusion, J-trim, pewter gray             |
| 16) 385995-02 | End cap, rub rail, casting, LH             |
| 17) 385955-01 | End cap, rub rail, casting, RH             |
| 18) 114584    | Extrusion, rub rail installation           |
| 19) 201709-02 | Rub rail molding, black                    |
| 20) 114570    | Extrusion, awning rail                     |
| 21) 114619    | Extrusion, roof corner cap                 |
| 22) 320115-06 | Screw, #6x1" flat head, stainless steel    |
| 23) 114077-04 | Trim extrusion, front cap to sidewall      |

\*Note: Each filler panel has a flange riveted on one or both sides (not shown). These are:

- |           |                  |
|-----------|------------------|
| 114594-01 | Seal, flange, LH |
| 114594-02 | Seal, flange, RH |

# 1998 LAND YACHT 30' & 33'

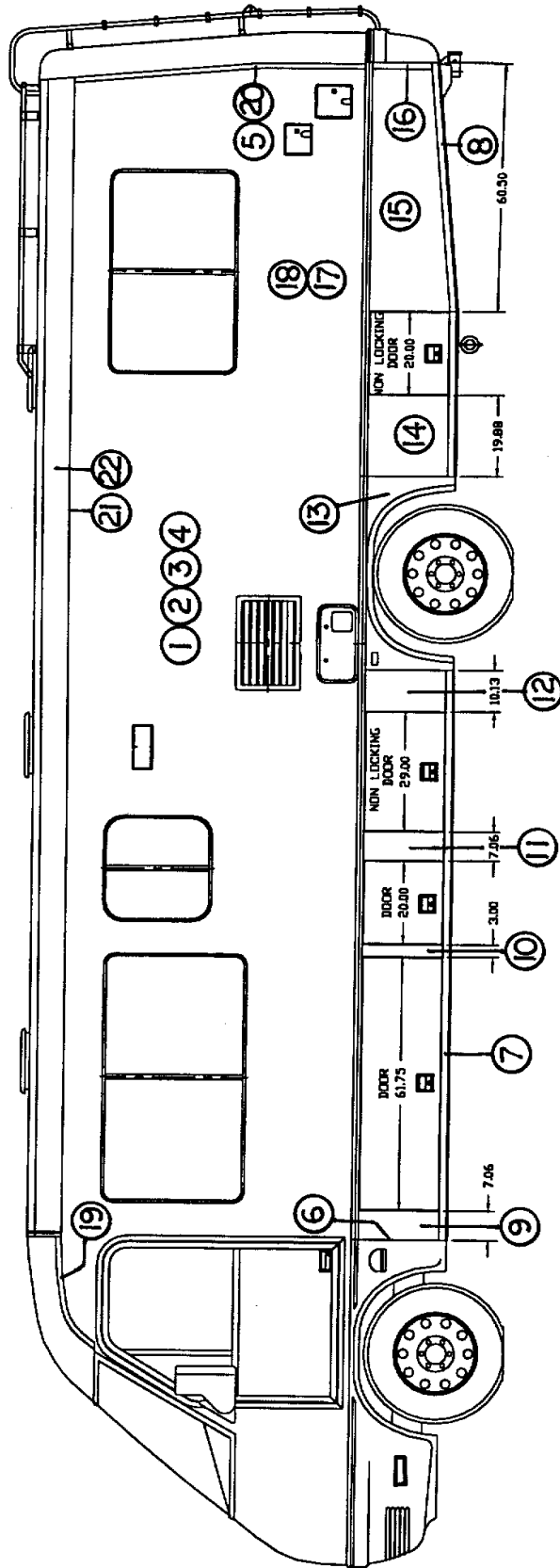



## 1998 LAND YACHT 30' & 33'

### \*BODY, ROADSIDE WALL, **30' ONLY**

- |               |   |
|---------------|---|
| 1) 801002-01  | Fiberglass sheet, frost white, 72"x332"     |
| 2) 915360     | Weldment, roadside wall, 30'                |
| 3) 203075     | Styrofoam sheet, 1 1/2" thick               |
| 4) 801176-03  | Paneling, inside, 1/8"x4'x7', G1S, Solitude |
| 5) 114005-02  | Trim molding, ends to sidewall              |
| 6) 114070-02  | Extrusion, J-trim, Pewter gray              |
| 7) 114019-02  | Extrusion, rocker panel, Pewter gray        |
| 8) 114591-01  | Extrusion, angled, rear rocker panel, RS    |
| 9) 114587-16  | Filler panel, 8.00"(oversize, cut to fit)   |
| 10) 114587-19 | Filler panel, 3.00"                         |
| 11) 114587-16 | Filler panel, 7.06"                         |
| 12) 114586-10 | Filler panel, 10.13"                        |
| 13) 201805    | Fender skirt                                |
| 14) 114585-10 | Filler panel, 19.88                         |
| 15) 114588    | Filler panel, angled, 60.50"                |
| 16) 114005-03 | Extrusion, lower cap to sidewall, gray      |
| 17) 114584    | Extrusion, rub rail installation            |
| 18) 201709-02 | Rub rail molding, black                     |
| 19) 114077-03 | Trim, extrusion, front cap to sidewall      |
| 20) 320115-06 | Screw, #6x1" flat head, stainless steel     |
| 21) 114570    | Extrusion, awning rail                      |
| 22) 114619    | Extrusion, roof corner cap                  |

\*Note: Each filler panel has a flange riveted on one or both sides(not shown) , These are:

114594-01Seal, flange, LH  
114594-02Seal, flange, RH

# 1998 LAND YACHT 30' & 33'

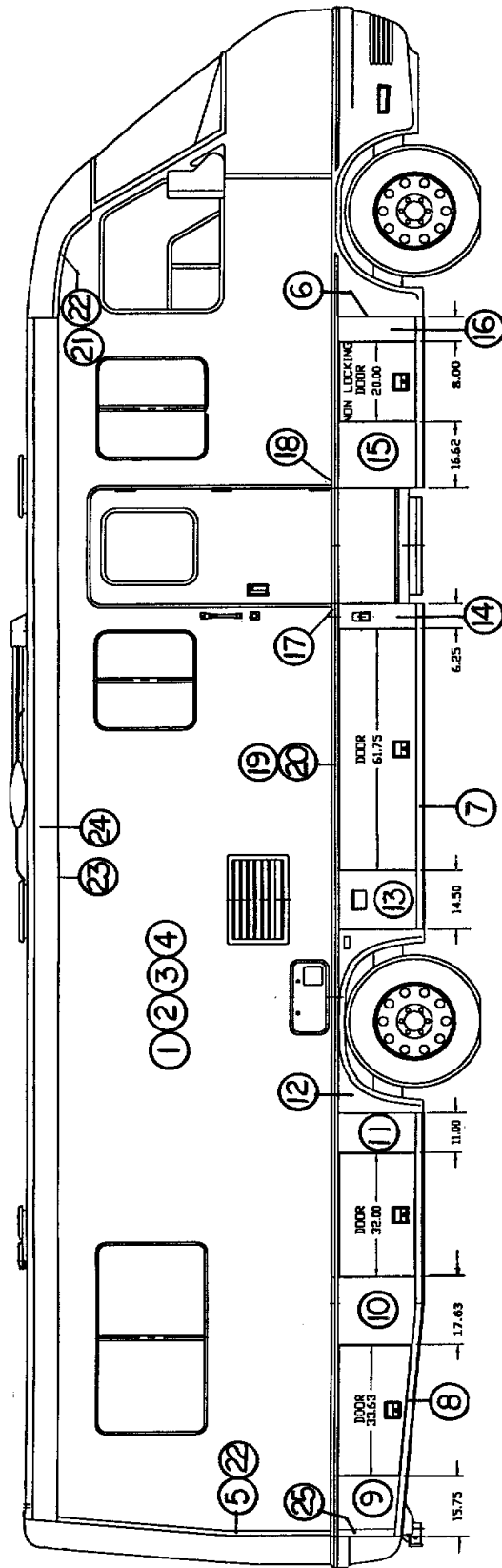

**1998 LAND YACHT 30' & 33'**  
**BODY, CURBSIDE WALL-33' ONLY**

- |               |   |
|---------------|---|
| 1) 801002-10  | Fiberglass sheet, frost white 72"x360"        |
| 2) 915227     | Weldment, CS wall, 33'                        |
| 3) 203075     | Styrofoam sheet 1 1/2" thick                  |
| 4) 801176-03  | Paneling, inside, 1/8 x 4' x 7' G1S, Solitude |
| 5) 114005-02  | Trim molding, ends to sidewall                |
| 6) 114070-02  | Extrusion, J-trim, pewter gray                |
| 7) 114583-01  | Extrusion, rocker panel, pewter gray          |
| 8) 114591-02  | Extrusion, angled, rear rocker panel, CS      |
| 9) 114589-01  | Filler panel, angled, CS, 15.75"              |
| 10) 114587-13 | Filler panel, 17.63                           |
| 11) 114586-04 | Filler panel, 10.75                           |
| 12) 201805    | Fender skirt                                  |
| 13) 114585-01 | Filler panel, 14.50                           |
| 14) 114586-17 | Filler panel, 6.25                            |
| 15) 114585-17 | Filler panel, 16.63                           |
| 16) 114585-16 | Filler panel, 8.0 (oversize, cut to fit)      |
| 17) 385955-02 | End cap, rub rail, casting, LH                |
| 18) 385955-01 | End cap, rub rail, casting, RH                |
| 19) 114584    | Extrusion, rub rail installation              |
| 20) 201709-02 | Rub rail molding, black                       |
| 21) 114077-04 | Trim extrusion, front cap to sidewall, CS     |
| 22) 320115-06 | Screw, #6x1", flat head, stainless            |
| 23) 114570    | Extrusion, awning rail                        |
| 24) 114619    | Extrusion, roof corner cap                    |
| 25) 114005-03 | Extrusion, trim, lower cap to filler panel    |

\*Note: Each filler panel has a flange riveted on one or both sides.  
These are:

- 114594-01 Seal, flange, LH
- 114594-02 Seal, flange, RH

# 1998 LAND YACHT 30' & 33'

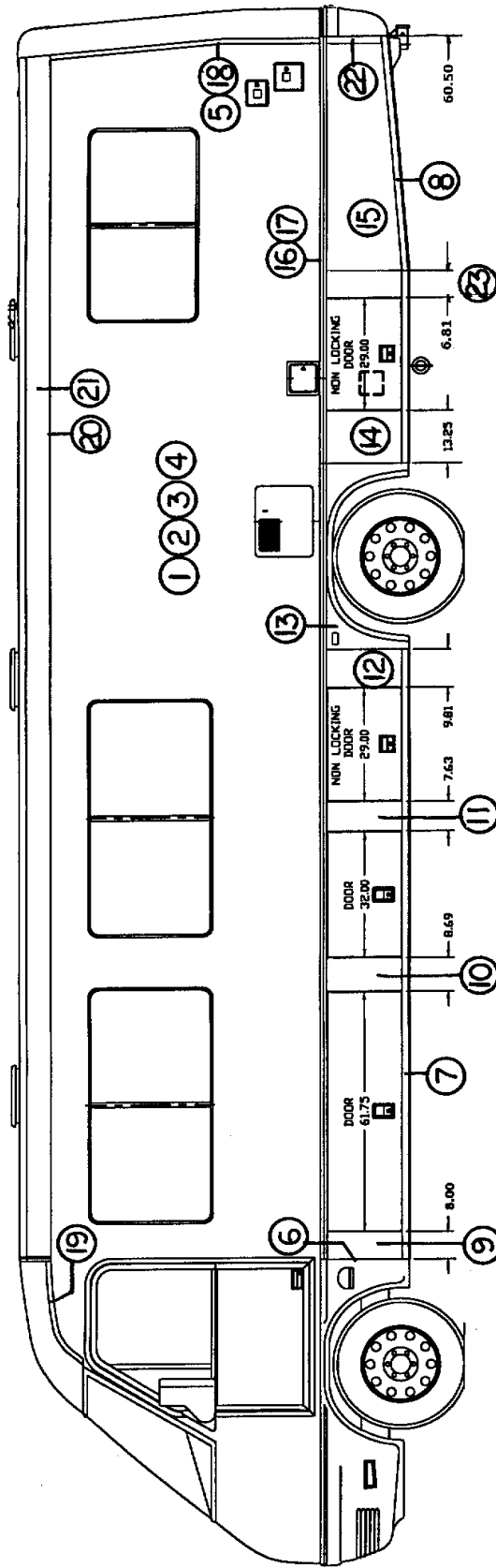

## 1998 LAND YACHT 30' & 33'

### \*BODY, ROAD SIDE WALL **33' ONLY**

- |               |  |
|---------------|--|
| 1) 801002-10  | Fiberglass sheet, frost white, 72"x360"      |
| 2) 915228     | Weldment, roadside wall, 33"                 |
| 3) 203075     | Styrofoam sheet, 1 1/2" thick                |
| 4) 801176-03  | Paneling, inside 1/8x4'x7', G1S, Solitude    |
| 5) 114005-02  | Trim molding, ends to sidewall               |
| 6) 114070-02  | Extrusion, J-trim, pewter gray               |
| 7) 114583-01  | Extrusion, rocker panel, pewter gray         |
| 8) 114591-01  | Extrusion, angled, rear rocker panel, RS     |
| 9) 114586-08  | Filler panel, 8.0" (over size, cut to width) |
| 10) 114587-09 | Filler panel, 8.69" wide                     |
| 11) 114587-10 | Filler panel, 7.63" wide                     |
| 12) 114586-01 | Filler panel, 9.81" wide                     |
| 13) 201805    | Fender skirt                                 |
| 14) 114585-04 | Filler panel, 13.25" wide                    |
| 15) 114588    | Filler panel, angled, 60.50" wide            |
| 16) 114584    | Extrusion, rub rail installation             |
| 17) 201709-02 | Rub rail molding, black                      |
| 18) 320115-06 | Screw, #6x1" flat head, stainless            |
| 19) 114077-03 | Trim, extrusion, front cap to sidewall, RS   |
| 20) 114570    | Extrusion, awning rail                       |
| 21) 114619    | Extrusion, roof corner cap                   |
| 22) 114005-03 | Extrusion, lower cap to sidewall, gray       |
| 23) 114586-16 | Filler panel, 6.81" wide                     |

\*Note: Each filler panel has a flange riveted on one or both sides(not shown) .These are:

114594-01Seal, flange, LH  
114594-02Seal, flange, RH

# 1998 LAND YACHT 30' & 33'

## BODY

## ROOF

203024	Fiberglass roof material, white, 106"W
915226	Weldment, roof, 33ft.
915237	Weldment, roof, 30ft.
203075	Styrofoam sheet 1 ½ thick
800507-01	Luan, 1/8" x 4' x 8'(inside)
702482	Headliner, Spectra Opal
201728-04	Extrusion, ceiling trim, white
201728	Extrusion, ceiling trim, retainer

# 1998 LAND YACHT 30' & 33'

## NOTES

# 1998 LAND YACHT 30' & 33'

## BODY-FRONT

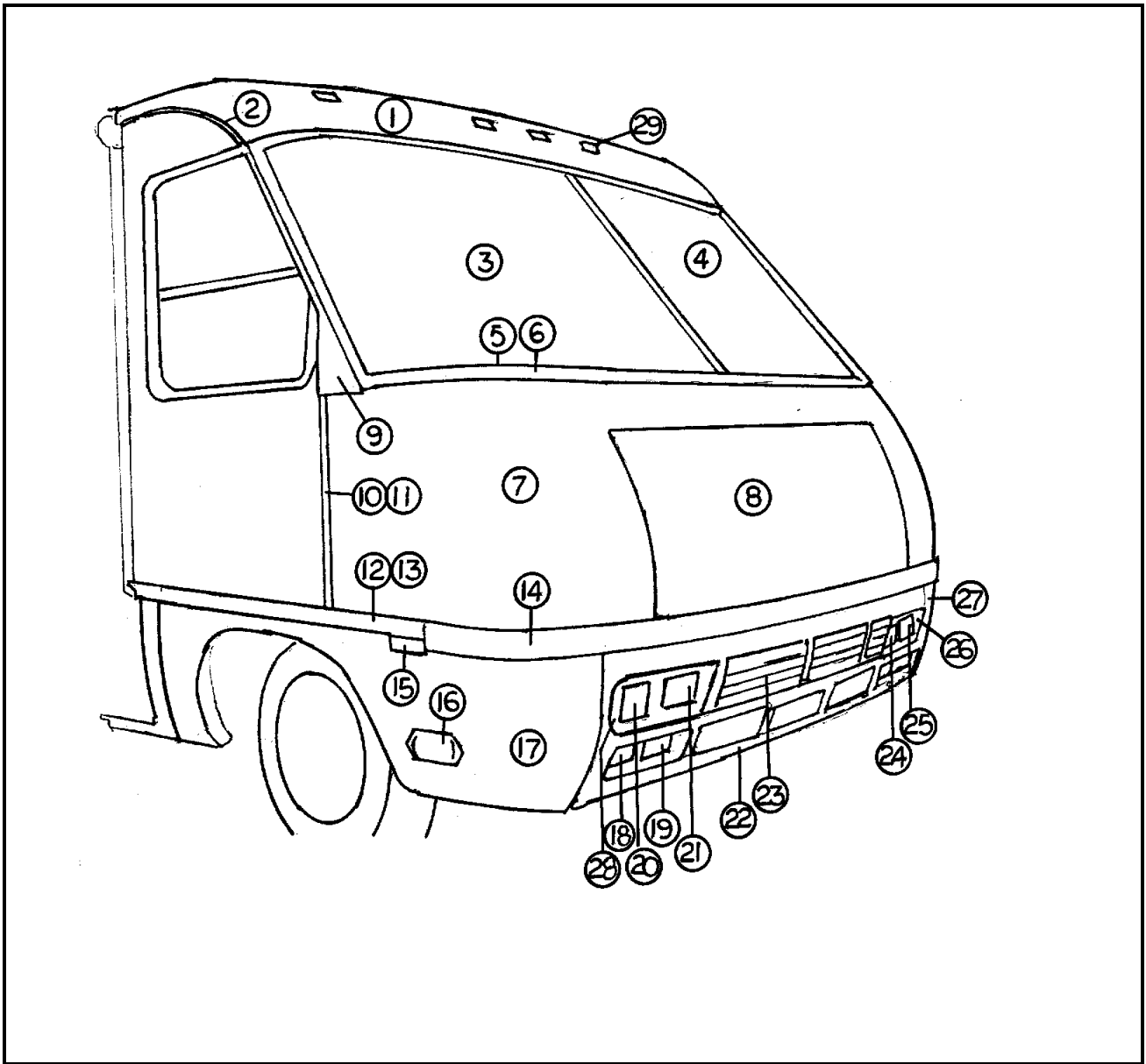



# 1998 LAND YACHT 30' & 33'

## BODY, FRONT

- 1) 201869-01 Front cap, Nu White
- 2) 114077-04 Trim, extrusion, cap to side wall, CS
- 114077-03 Trim, extrusion, cap to side wall, RS
- 3) 371291 Windshield, CS
- 4) 371290 Windshield, RS
- 5) 381319 Gasket, windshield(surrounds both windshields)
- 6) 201260 Insert, windshield gasket
- 7) 201855-02 Nose, Nu white
- 8) 201856-02 Hood, fiberglass, Nu white
- 9) 114838-01 Cover, A pillar, CS
- 114838-02 Cover, A pillar, RS
- 10) 114005-02 Trim molding, nose to sidewall
- 11) 320115-06 Screw, #6x1" flathead, stainless
- 12) 114584 Extrusion, rub rail installation
- 13) 201709-02 Rub rail molding, black
- 14) 201909 Molding, black bumper trim
- 15) 500982 Light, clearance/turn signal, amber
- 16) 511101 Light, docking, halogen
- 17) 201971 Fender, CS
- 18) Light, turn signal, amber, GM#916558
- 19) 511094 driving light kit, halogen
- 20) 510739-03 Headlamp, halogen, LO, CS
- 21) 510739-02 Headlamp, halogen, HI, CS
- 22) 201972 Bumper, front
- 23) 923085 Grill assembly
- 24) 510739-04 Headlamp, halogen, RS, HI
- 25) 510739-02 Headlamp, halogen, RS.LO
- 26) 201970 Fender, RS
- 27) 201883-01 Trim ring, headlight, RS
- 28) 201883-02 Trim ring, headlight, CS
- 29) 510984-02 Light, clearance, amber

# 1998 LAND YACHT 30' & 33'

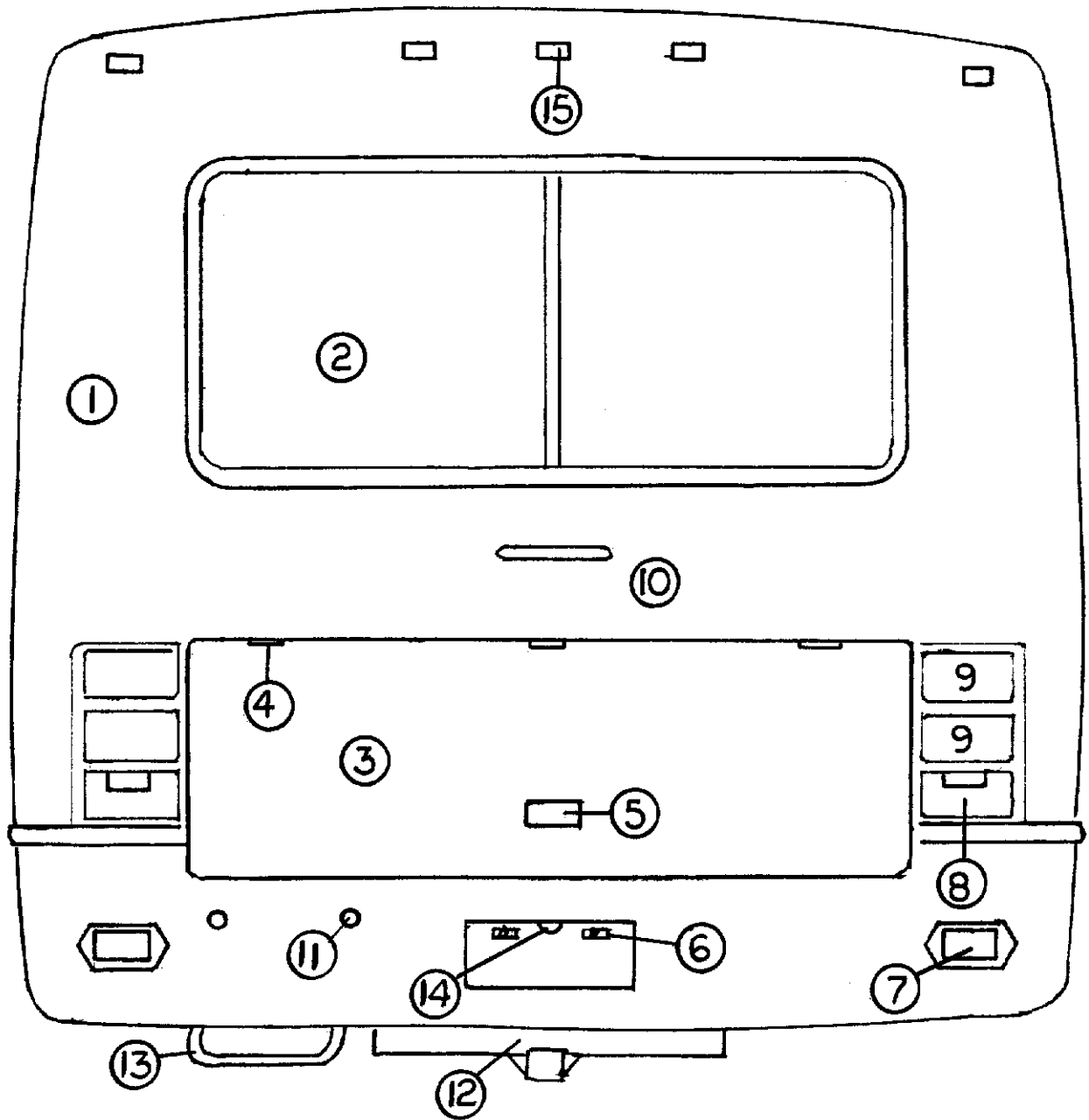

# 1998 LAND YACHT 30' & 33'

## BODY-AFT

- 1) 203088 Cap, rear end
- 2) 371593-02 Window, stationary, rear, 29.25x62.25
- 3) 203018-01 Trunk door, Land Yacht, Nu white
- 4) 381434 Hinge, stainless, 3"x3"
- 5) 195373 Paddle latch, black, w/lock
- 6) 381077 Well nut, license plate
- 7) 511101 Light, docking, halogen
- 8) 511240 Light-stop/tail/turn/back-up
- 9) 511239 Light-stop/tail/turn
- 10) 511154-02 Light strip, 3rd brake light, 1x10"
- 11) 381148-01 Socket, bottom support, ladder
- 12) 400868 Hitch, Reese #38502
- 13) 914120 Step assembly, bottom, roof ladder
- 14) 511294 Light, license plate
- 15) 510984-01 Light, clearance, red

### NOT SHOWN

- 381578 Ladder
- 114224 Plunger, bottom support, ladder

# 1998 LAND YACHT 30' & 33'

## NOTES

## 1998 LAND YACHT 30' & 33'

### CHASSIS

400868	Reese hitch, model 38502
410796-01	Jack kit complete, Power Gear, opt.
961601	Step assy., roof ladder
410700	Step, single, Kwikkee#2858
511078	Switch, rocker, 4-gang
500982	Switch, magnetic, round, 3/8
685031-01	Control box, main, Kwikkee
410700-100	Motor, assy., w/actuator arm
410818	Wheel simulator
400571	Mud flaps, pair
690311	Heater, rear, auxiliary
510929-04	Switch, dash, rear heat
600678	Adapter grill, heat duct 10x2
203070	Register, plastic, brown
452087	Hanger, spare tire
410631	Winch, spare tire
381379-01	Wrench, speed, 3/8 drive
381379-03	Socket, speed wrench

# 1998 LAND YACHT 30' & 33'

## CHASSIS

*690382-03	Kit heater/evaporator, Acme
690382-02	Plenum kit bi-level, short
690315-05	Grille, defroster duct
601599	Hose , duct2"
600465	Hose, air duct 2 1/2" dia.
203110	Duct , defroster trans
6000283	Vacuum hose, 3/16 dia.
690382-05	Suction hose kit, Chevy L29
690315-03	Cable, temperature control, 106"
600214-03	Heater hose, 5/8"

\*Chevrolet installs the compressor, condenser and associated parts on their RV chassis.

# 1998 LAND YACHT 30' & 33'

## SECTION II

### D through E

#### DASH

Dash parts .....	II-1
Glove box .....	II-1
Trims .....	II-1
Defrost nozzle .....	II-1
Rear view mirror .....	II-1
Sun visors.....	II-1
Windshield wiper.....	is II-2

DECALS .....	II-7
--------------	------

#### DOORS/WINDOWS/AWNINGS

33ft.RS.....	II-11
33ft.CS.....	II-13
30ft.RS.....	II-15
30ft.CS.....	II-17

DRAPES/BLINDS/VALANCES .....	II-19
------------------------------	-------

#### ELECTRICAL

110 volt.....	II-21
12 volt .....	II-23
Dash switches/lens.....	II-25

#### ENTERTAINMENT

Televisions .....	II-29
Radios.....	II-29
Antenna.....	II-25





# 1998 LAND YACHT 30' & 33'

## DASH

201754-02	Dash top
203128-01	Dash face
702476-05	Cover, vinyl, dash, sewn w/pad
201958	Glove box
201833	Door, glove box
201853	Close out, steering column
* 964029-01	Switch cluster assembly
510931-01	Bezel, dash switch, 4-sw
201845-01	Nozzle, defroster duct, outer
201845-02	Nozzle, defroster duct, inner
371243	Mirror, rear view, interior, GM911722
380990	Bracket, interior rear view mirror GM#9831062
511305	Mirror, exterior, Velvac w/remote
381321-03	Switch, remote, Velvac mirror
381515-04	Visor, front windshield

\*See electrical section for detail

# 1998 LAND YACHT 30' & 33'

## DASH WIPER ASSEMBLY

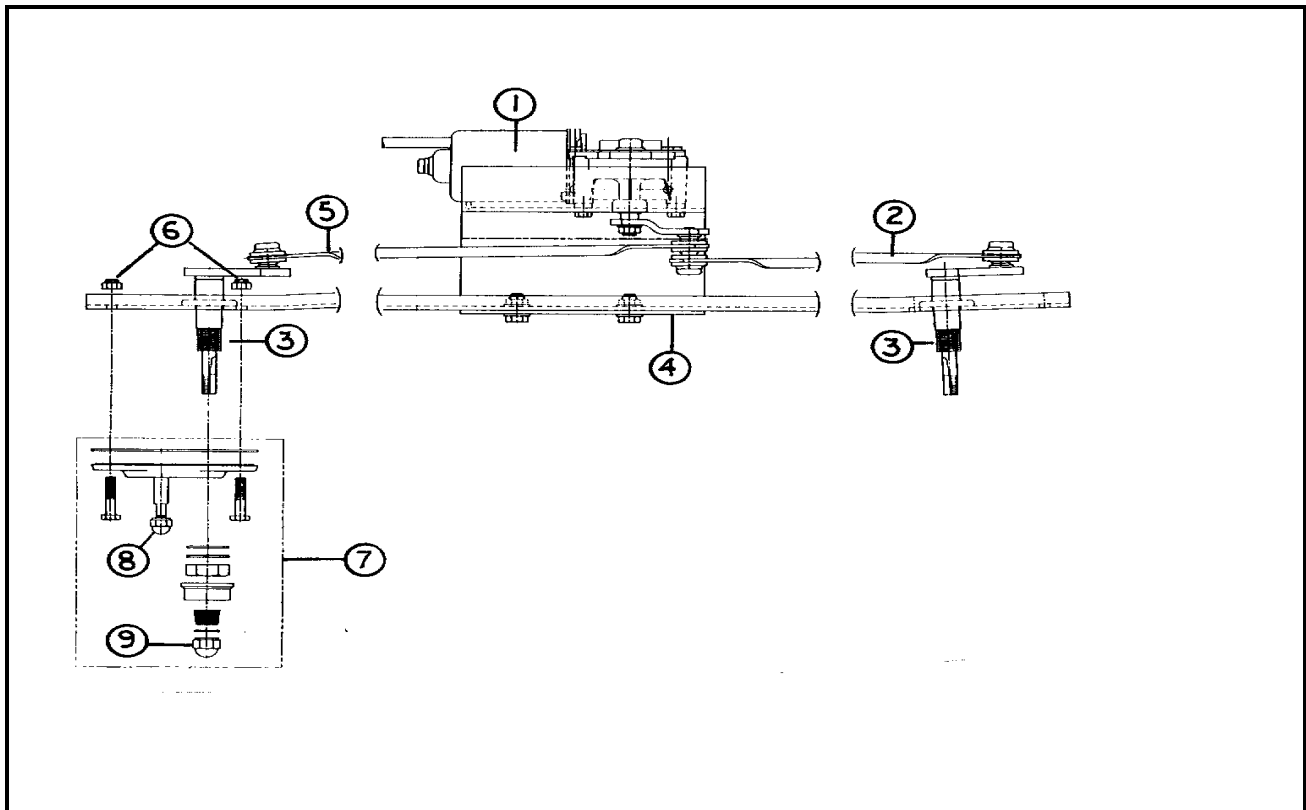

- |               |   |
|---------------|---|
| 1) 510795-118 | Motor assy.E-005-308                            |
| 2) 510795-119 | Conlink assy., R.S.L1/3B4/3/22.00               |
| 3) 510795-105 | Idler/HSG assy. (pivot shaft) GS-2967           |
| 4) 510795-120 | Mounting bracketS-547                           |
| 5) 510795-121 | Conlink assy..C.S.L1/3d3/3/22.00                |
| 6) 510795-122 | Lock nut1/4-28                                  |
| 7) 510795-123 | Outer hardwareG-S-2656                          |
| 8) 510795-115 | Acorn nut, small, pantograph arm to pivot plate |
| 9) 510795-114 | Acorn nut, large, pantograph arm to pivot       |

continued

# 1998 LAND YACHT 30' & 33'

## DASH

### WIPER ASSEMBLY

Parts not illustrated

510795-107	Wiper blade refill
510795-101	Wiper blade and bridge
510795-104	Pantograph arm assembly
510675-01	Switch, wiper w/delay
511233-01	Module, wiper delay

# 1998 LAND YACHT 30' & 33'

## NOTES

## 1998 LAND YACHT 30' & 33'

### DECALS

THE 30FT. AND 33FT. LAND YACHTS SHARE THE SAME DECALS EXCEPT, OBVIOUSLY, WHERE THE "THREE" IS NOT USED BY THE THIRTY ON THE SHORTER UNITS.

CURBSIDE AND ROADSIDE DECALS ARE THE SAME EXCEPT FOR ITEMS #1 AND #10. YOU'LL SEE THE PART NUMBERS FOR CS AND RS LISTED UNDER THESE ITEM NUMBERS.

# 1998 LAND YACHT 30' & 33'

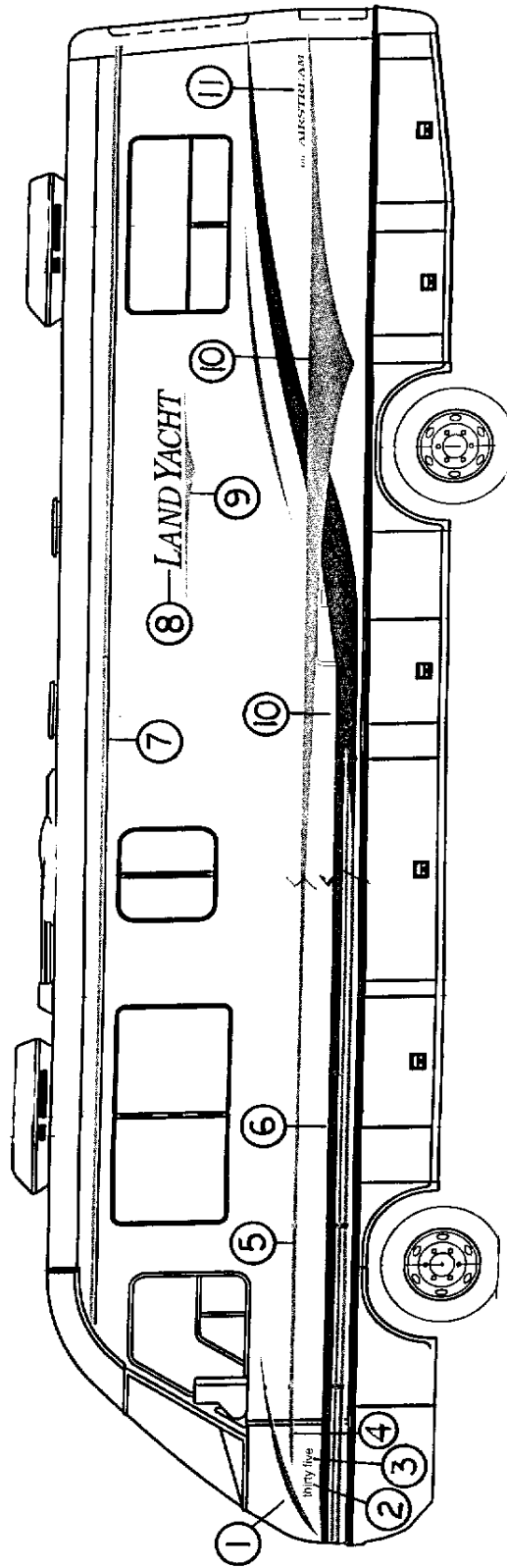

# 1998 LAND YACHT 30' & 33'

## DECALS

- |               |                                     |
|---------------|-------------------------------------|
| 1) 385957-05  | Sweep, front end, RS                |
| 385957-04     | Sweep, front end, CS                |
| 2) 385960-01  | Decal, "thirty"                     |
| 3) 385960-03  | Decal, "three"                      |
| 4) 385957-10  | Decal, end cap (continuation of #5) |
| 5) 385957-03  | Decal stripe, 1"                    |
| 6) 385957-02  | Decal stripe, main body, 4 3/4"     |
| 7) 385957-01  | Decal stripe, top , 2"              |
| 8) 385957-08  | Decal, Land Yacht logo, large, 52"  |
| 9) 385957-09  | Decal graphic, upper side           |
| 10) 385957-07 | Decal, graphic, main body, RS       |
| 385957-06     | Decal, graphic, main body, CS       |
| 11) 385957-15 | Decal, "by Airstream"               |

decals not shown

- |           |  |
|-----------|--|
| 385957-14 | Decal, Airstream logo, large, 2.25x50.5"       |
| 385957-12 | Decal, Land Yacht logo, medium, 20"rear        |
| 385957-11 | Decal, graphic, rear trunk door                |
| 385957-13 | Decal, Land Yacht logo, small, 7", front       |
| 385582-01 | Decal, Airstream w/bar-air conditioner. Shroud |

# 1998 LAND YACHT 30' & 33'

## NOTES



## 1998 LAND YACHT 30' & 33'

### DOORS/WINDOWS/AWINNGS

SINCE THE EXTERIOR DOORS AND WINDOWS ARE DIFFERENT ON 30 AND 33FT. MODELS YOU'LL SEE THE APPROPRIATE LENGTH MARKED IN THE HEADING OF EACH PARTS LIST.

LOOK FOR **30' ONLY** OR **33' ONLY** IN BOLD TYPE.

# 1998 LAND YACHT 30' & 33'

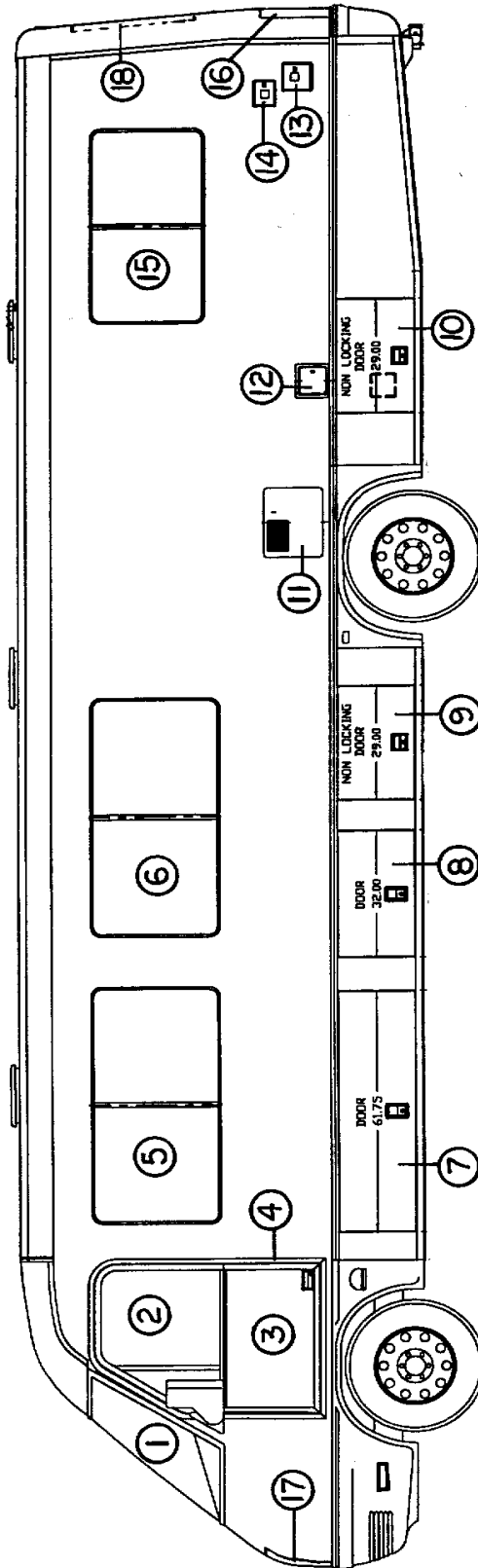

# 1998 LAND YACHT 30' & 33'

THIS PAGE **33' ONLY**

## DOORS/WINDOWS/AWNINGS

(Hardware such as hinges, locks and latches are located in the **hardware** section of this book)

### ROADSIDE

- |               |   |
|---------------|---|
| 1) 371290     | Windshield, RS                            |
| 2) 372195     | Window, drivers door                      |
| 3) 922328     | Drivers door assembly                     |
| 4) 195279-02  | Jamb, drivers door                        |
| 5) 371593-05  | Window, horizontal slide, 29.75x60.25, RS |
| 6) 371593-05  | Window, horizontal slide, 29.75x60.25, RS |
| 7) 921166-01  | Compartment door, 61.75                   |
| 8) 921166-02  | Compartment door, 32.00                   |
| 9) 921169-03  | Compartment door, non-locking, 29.00      |
| 10) 921169-03 | Compartment door, non-locking, 29.00      |
| 11) 690259-03 | Cover/mounting flange, water heater       |
| 12) 201865-02 | Fuel fill housing, polar white            |
| 13) 511045-02 | Cord door hatch, 110volt                  |
| 14) 921178    | Water fill, potable water tank            |
| 15) 371593-22 | Window, horiz. slide, egress, 30.25x48.88 |
| 16) 203018-01 | Trunk door , LY, Nu white                 |
| 17) 201856-02 | Hood, fiberglass, Nu white                |
| 18) 371593-02 | Window, stationary, rear, 29.25x62.25     |

# 1998 LAND YACHT 30' & 33'

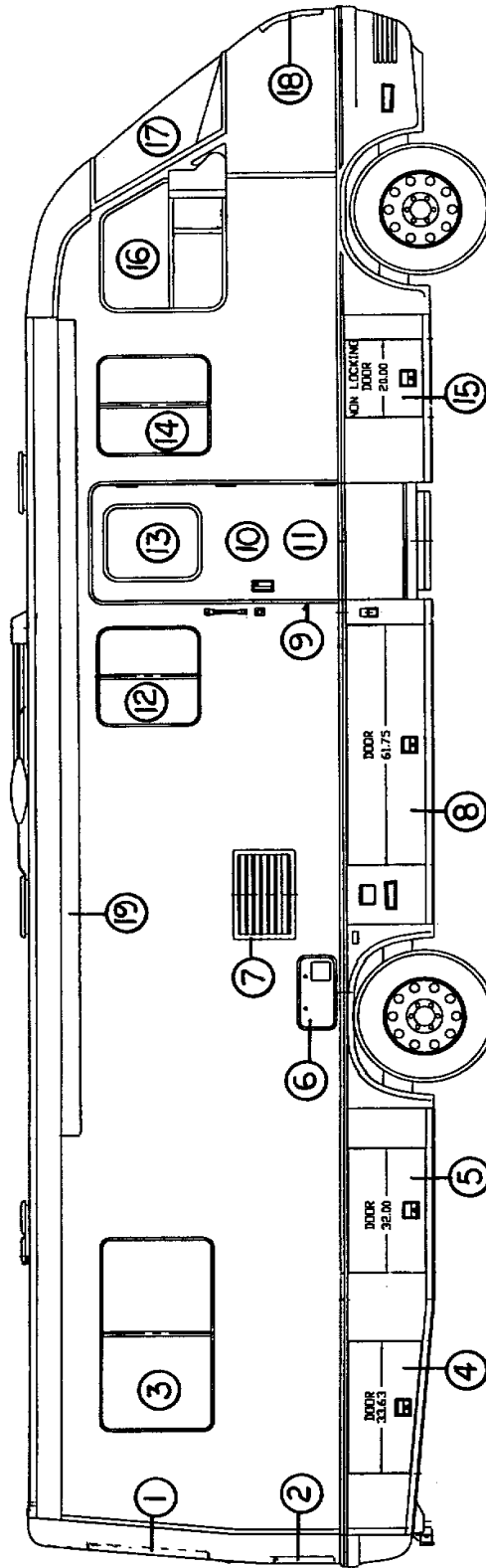

# 1998 LAND YACHT 30' & 33'

THIS PAGE **33' ONLY**

## DOORS/WINDOWS/AWNINGS

(Hardware such as hinges, locks and latches are located in the **hardware** section of this book)

### CURBSIDE

- 1) 371593-02 Window, stationary, rear, 29.25x62.25
- 2) 203018-01 Trunk door, LY, Nu white
- 3) 371593-21 Window, horizontal slide, 30.25x48.88, CS
- 4) 921167-01 Compartment door, angled, CS, 33.63
- 5) 921166-02 Compartment door, 32.00
- 6) 690274-05 Door, Hydroflame, exterior
- 7) 690340-01 Door, refrigerator, flush mount
- 8) 921166-01 Compartment door, 61.75
- 9) 922375-02 Door jamb assembly
- 10) 109988 Main door
- 11) 922372 Screen door assembly
- 12) 371593-09 Window, horizontal slide, 25.25x25.75, CS
- 13) 371593-01 Window, main door, 19.25x23.25
- 14) 371593-10 Window, horizontal slide, 29.75x26.25, CS
- 15) 921169-04 Compartment door, non-locking, 20.00
- 16) 371359-01 Window, cab, CS, angled
- 17) 371291 Windshield, CS
- 18) 201856-02 Hood, fiber glass, Nu white
- 19) 702679-16 Awning, patio, 17', Blue Shadows

# 1998 LAND YACHT 30' & 33'

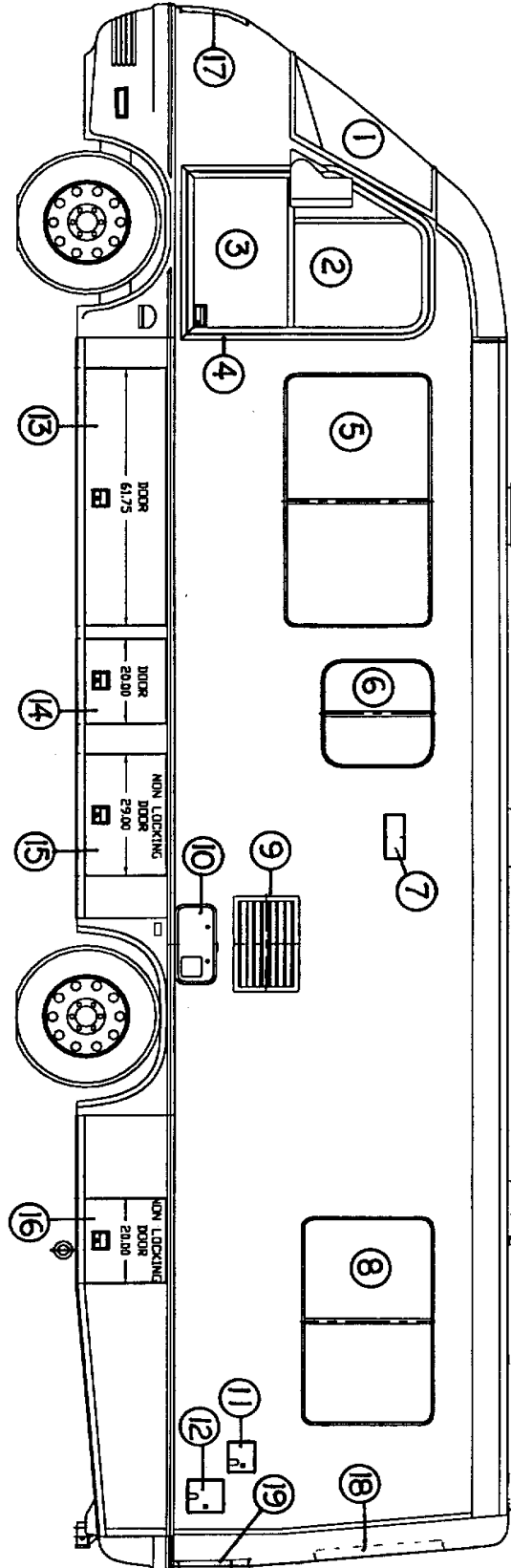

# 1998 LAND YACHT 30' & 33'

## DOORS/WINDOW/AWNINGS-**30'ONLY**

(Hardware such as hinges, locks and latches are located in the **hardware** section of this book)

### ROADSIDE

- |               |   |
|---------------|---|
| 1) 371290     | Windshield, RS                                |
| 2) 372195     | Window, drivers door                          |
| 3) 922328     | Drivers door assembly                         |
| 4) 195279-02  | Jamb, drivers door                            |
| 5) 371593-05  | Window, horiz. slide, RS, 29.75x60.25         |
| 6) 371593-04  | Window, horiz. slide, RS, 25.25x25.75         |
| 7) 511152-01  | Vent cover, range exhaust                     |
| 8) 371593-22  | Window, horiz. slide, RS, egress, 30.25x48.88 |
| 9) 690340-01  | Door, refrigerator, flush mount               |
| 10) 690274-05 | Door, Hydroflame, exterior                    |
| 11) 921178    | Water fill, potable water                     |
| 12) 511045-02 | Cord door hatch, 110 volt                     |
| 13) 921166-01 | Compartment door, 61.75"                      |
| 14) 921166-04 | Compartment door, 20.00"                      |
| 15) 921169-03 | Compartment door, non-locking, 29.00"         |
| 16) 921169-04 | Compartment door, non-locking, 20.00"         |
| 17) 201856-02 | Hood, fiberglass, Nu white                    |
| 18) 371593-02 | Window, stationary, rear, 29.25x62.25"        |
| 19) 203018-01 | Trunk door, LY, Nu white                      |

# 1998 LAND YACHT 30' & 33'

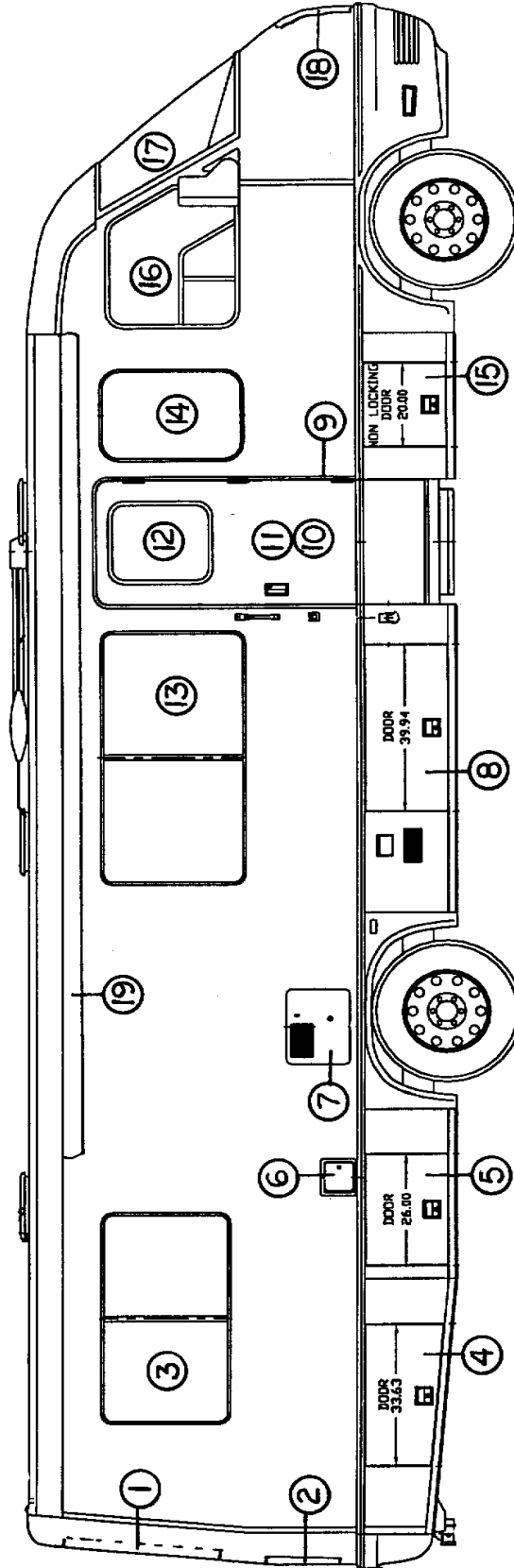



# 1998 LAND YACHT 30' & 33'

## DOORS/WINDOWS/AWNINGS-30' ONLY

(Hardware such as hinges, locks, and latches are located in the **hardware** section of this book)

### CURBSIDE

- |               |  |
|---------------|--|
| 1) 371593-02  | Window, stationary, rear, 29.25x62.25  |
| 2) 203018-01  | Trunk door, Nu white                   |
| 3) 371593-21  | Window, horiz., slide, CS, 30.25x48.88 |
| 4) 921167-01  | Compartment door, CS, angled, 33.63"   |
| 5) 921166-08  | Compartment door, 26.00"               |
| 6) 201865-02  | Fuel fill housing, polar white         |
| 7) 690259-03  | Cover/mounting flange, water heater    |
| 8) 921166-05  | Compartment door, 39.94                |
| 9) 922375-02  | Door jamb assembly                     |
| 10) 109988    | Main door                              |
| 11) 922372    | Screen door assembly                   |
| 12) 371593-01 | Window, main door, 19.25x23.25"        |
| 13) 371593-06 | Window, horiz., slide, CS, 29.75x60.25 |
| 14) 371593-08 | Window, stationary, CS, 29.75x21.50    |
| 15) 921169-04 | Compartment door, non-locking, 20.02"  |
| 16) 371359-01 | Window cab, CS, angled                 |
| 17) 371291    | Windshield, CS                         |
| 18) 201856-02 | Hood, fiberglass, Nu white             |
| 19) 702679-16 | Awning, patio, 17', Blue Shadows       |

# 1998 LAND YACHT 30' & 33'

## NOTES

1998 LAND YACHT 30' & 33'  
 DRAPES/BLINDS/VALANCES

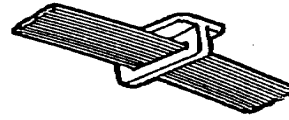

101220  
 track, standoff

101217  
 track, curtain

700044  
 glides, w/elastic T

200784 End, curtain track, CS  
 200785 End, curtain track, RS  
 702878-02 Drapes, front windshield

702355-06 Shade, pull, main door

702383-09 Shade, pleated, day/night 30.68x26"  
 702383-04 Shade pleated, day/night 27.0x27.5"  
 702789-20 Shade, pleated, night 63.0x31.50"  
 702383-05 Shade, pleated, day/night 27.25x33.50"  
 702789-28 Shade, pleated, night 50.0x32.50"  
 702383-19 Shade, pleated, day/night, 61.25x33.50  
 702383-03 Shade, pleated, day/night, 22.50x33.50

385963 Bracket, valance mounting, side

964464-01 Valance, CS bedroom 53"  
 964464-02 Valance, RS bedroom 53"  
 964126 Valance, bedroom rear 62.50"  
 964117-01 Valance, galley, 30' model  
 964117-02 Valance, galley, 33' model  
 964121-01 Valance, dinette/RS lounge 64.25"  
 964121-02 Valance, dinette/CS lounge 64.25"  
 964120-01 Valance, at swivel chair

# 1998 LAND YACHT 30' & 33'

## NOTES

# 1998 LAND YACHT 30' & 33'

## ELECTRICAL

110 VOLT

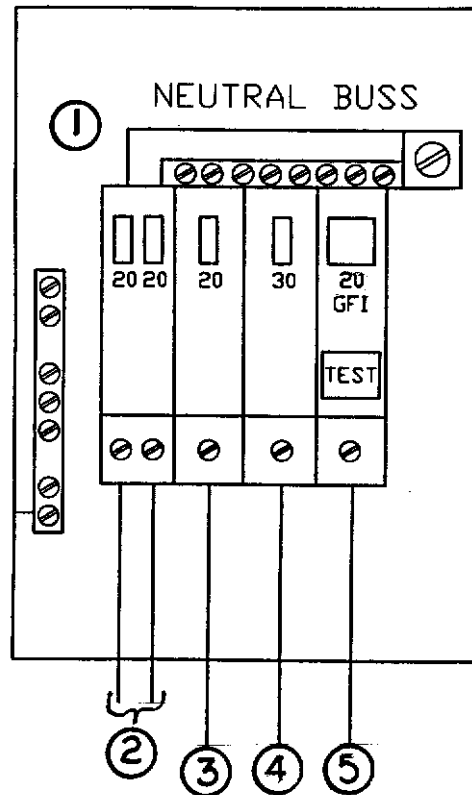

- |           |  |
|-----------|--|
| 1) 511336 | Breaker box, Square D, 30 amp                  |
| 2) 510662 | Breaker, 20 amp, double, Square D 2020         |
| 3) 510678 | Breaker, 20amp, Square D 0120                  |
| 4) 510663 | Breaker, 30 amp, Square D 0130                 |
| 5) 510661 | Breaker, 20 amp, Square D GFI                  |
| 510634    | Power cord, 120volt, 36 ft.                    |
| 500984-04 | Converter, #PC-50                              |
| 510562    | Switch over relay, automatic, shore to gen.    |
| 510514    | Switch, priority, microwave to air conditioner |
| 510606    | Receptacle box, priority switch                |
| 500385    | Switch cover, ivory                            |

# 1998 LAND YACHT 30' & 33'

110 VOLT

510676-01	Receptacle, weatherproof, w/cover
511207	Cover, weatherproof receptacle
511038	Generator, Onan, 5.0 Marquis
510103	Hour meter

# 1998 LAND YACHT 30' & 33'

## \*ELECTRICAL

### 12 VOLT

511132	Battery, deep cycle
511273	Tray, battery hold down
500984-04	Converter, #PC-50
511351	Solenoid, latching, continuous duty (kill switch)
511199	Solenoid, continuous duty, (auxiliary start)
510642	Isolator
511016	Fuse block, 12 volt, 9 position, ATC
500475-05	Circuit breaker, 12 volt, 5amp, w/ears
500475-25	Circuit breaker, 12 volt, 25amp, w/ears
500475-50	Circuit breaker, 12 volt, 50amp, w/ears
511090	Stud type junction block
511233-01	Module, wiper delay, single motor
511236	Harness, wiper/washer
510914	Terminal, relay block
510844-01	Relay, Bosh #86-117
510843	Flasher, heavy duty

\*See **ENTERTAINMENT SECTION** for radio, VCR, television, antennas, etc.

# 1998 LAND YACHT 30' & 33'

## ELECTRICAL

### 12VOLT

510739-03	Headlamp, halogen, CS, Hi
510739-04	Headlamp, halogen, RS, Hi
510739-01	Headlamp, halogen, CS, Lo
510739-02	Headlamp, halogen, RS, Lo
380644	Screw, directional adj. headlight
381376	Spring, headlight tension
511094	Diving light kit, halogen
Front turn signal, amber-GM #916558	
500892	Light, reflector/reflector, amber
510984-0	2Light side/side marker, amber
510984-01	Light, clearance, red
511240	Light, tail/turn/stop/back-up
511239	Light, tail/turn/stop
511154-02	Light strip, 3rd brake light 1"x10"
511294	Light, license plate
511101	Light, docking, halogen, black bezel
511101-01	Light, docking, halogen , stainless steel
201991	Housing docking light
510732	Light, utility #1327 (by door)
510672-02	Light, porch (high on side of unit)
511163	Light, compartment
510734	Alarm, back-up
510976	Buzzer, headlight warning GM#999373



# 1998 LAND YACHT 30' & 33'

## ELECTRICAL

### 12 VOLT\*DASH SWITCHES

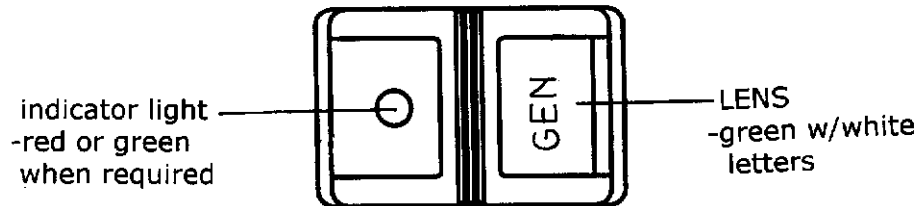

### DASH SWITCH

510929-05	Switch, driving light/aisle light/galley light/defrost fan, on-off, SPST
510929-02	Switch, auxiliary start, momentary, SPST
510929-08	Switch, rear camera, momentary, DPDT
510929-04	Switch, rear heat, on-off-on, SPST
510929-07	Switch, docking light, on-off w/red indicator. SPST
510929-06	Switch, TV audio through sound system
510929-01	Blank, switch, dash
510931-01	Bezel, dash switches-4sw
381321-03	Switch, exterior mirror
195386	Switch, momentary, on-off, window, cap door
510931-01	Switch, wiper w/delay

\*Note: the chassis manufacturer provides Engine check and headlight switches.

# 1998 LAND YACHT 30' & 33'

## ELECTRICAL

12 VOLT Lens with print for dash switches

510930-02	Lens, door lock
510930-03	Lens, generator
510930-04	Lens. rear heat
510930-06	Lens, aisle light
510930-07	Lens, docking light
510930-25	Lens , rear camera
510930-28	Lens, driving light
510930-31	Lens TV speaker
510930-32	Lens galley light
510930-33	Lens, auxiliary start
510930-34	Lens, invertors
510930-35	Lens, defrost fan

# 1998 LAND YACHT 30' & 33'

## ELECTRICAL

### 12VOLT

511305	Mirrors, exterior, Velvac, pr.
511305-04	Cable extension, exterior mirror, 5.5'
511305-03	Cable extension, exterior mirror, 11.0'
511044-03	Actuator, two position, rear camera
510802-01	Actuator, door lock, 5-wire
511352	Module, locking, keyless entry
195285-05	Power window regulator, Rockwell
510814	Switch, push pin type-drivers door jamb
511140	Solar panel, 5watt
511140	Voltmeter, solar panel
510807	Outlet, 12volt
511276	Cover, 12 volt outlet, black
510596	Cigarette lighter, chrome
510688	Switch, 4-gang, bathroom
500933	Switch, water heater
511078	Switch, 4-gang, at entrance door
511083-02	Cover, 4-gang switch at entrance door
511152-11	Range hood w/monitor, black
381507	Clock-quartz-w/gold trim
500996	Jack, TV/phone, gray
510624-01	Modular, telephone jack-bedroom

# 1998 LAND YACHT 30' & 33'

## ELECTRICAL

### 12 VOLT

500960-01 680084	Light, fluorescent, recessed, 14.75 Bulb, fluorescent, F8T5-CW
500960-02 680085	Light, fluorescent, received, 20.63 Bulb, fluorescent, F15T8-CW
511248 50085-02	Light, incandescent, single Bulb, incandescent, 1141
511098 50085-02	Light, decorative over dinette Bulb, incandescent, 1141
511298 510689 511298-02	Wall lamp, 12 volt Bulb, incandescent, 1076 Shade, wall lamp
500956 681924	Light, wardrobe, w/switch Bulb, wardrobe light, 581
511361	Light, courtesy, flush mount, dash, black separate bulb not available
510973 001003 511031	Light dome, triple, black Bulb, map light/closet light, 1003 Bulb, dome light, 168

## 1998 LAND YACHT 30' & 33'

### ENTERTAINMENT

690385	TV, Audiovox, 19"
511373-01	Theater sound system, 2-18 watt amplifiers (puts TV through front speakers)
690330-02	TV, Panasonic 13"
510918-01	Monitor, Sony Watchman
510929-08	Switch, momentary, rear camera
511044-03	Actuator, two position, rear camera
201888	Closeout, monitor camera, interior
203030	Closeout, monitor camera, exterior
201843	Lens, back-up monitor
690337	Video cassette player, Audiovox
511310	Video control center
511371	Radio, Sony XR-C5100
511048	Speaker set, Coustic-HS-402
510788-01	Antenna, TV, Winegard
510788-03	Amplifier, antenna, Winegard
510788-107	Gear, elevating, plastic, Winegard
510788-118	Handle, directional kit, Winegard
510616	Connector, "F", coax
510623	Connector, male to male, coax
500994	Antenna, radio



# 1998 LAND YACHT 30' & 33'

## SECTION III

### F through H

FASTENERS (common fasteners available locally are not listed)

Rivets.....	III-1
Screws .....	III-3

### FLOOR COVERING

Carpet.....	III-5
Hardwood flooring .....	III-5
Mats .....	III-5

### FURNITURE

Interior doors .....	III-7
Mirrors .....	III-7
Drawer face.....	III-8
Drawer box .....	III-8
Bedroom furniture .....	III-9
Bath, 30ft. ....	III-11
Bath, 33ft. ....	III-12
Galley, 30ft. ....	III-13
Galley, 33ft. ....	III-15
Lounge/cab, 30ft.....	III-17
Lounge/cab, 33ft.....	III-19

### HARDWARE

Props .....	III-21
Exterior locks/hinges .....	III-21
Interior drawer slides/hinges/catches .....	III-24
Bath accessories .....	III-25
Awning hardware .....	III-27





# 1998 LAND YACHT 30' & 33'

## \*FASTENERS

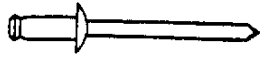

330126-02  
rivet, pop, dia. 1/8"  
grip range .126-.187  
stainless steel body  
stainless steel mandrel

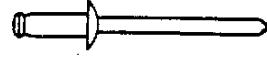

330126-03  
rivet, pop, dia 1/8"  
grip range .126-.250  
stainless steel body  
stainless steel mandrel

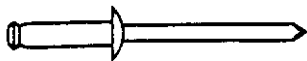

330136-04  
rivet, pop, dia. 1/8"  
grip range .313-.375  
stainless steel body  
stainless steel mandrel



330031-03  
rivet, pop, dia 3/16"  
grip range .125-.250  
stainless steel body  
stainless steel mandrel



330031-03  
rivet, pop  
dia.3/16"  
grip range .126-.250  
stainless steel body  
steel mandrel



320108-01  
rivet, bulb tite, w/washer  
dia. 3/16"  
grip range .050-.187  
aluminum body  
aluminum mandrel

\*Common bolts and screws readily available at local hardware outlets have not been listed.

# 1998 LAND YACHT 30' & 33'

## \*FASTENERS

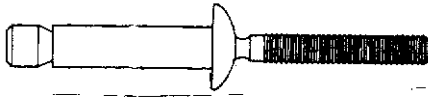

330139-02  
dia. 1/4"  
grip range .350-.625  
stainless steel body  
stainless steel mandrel

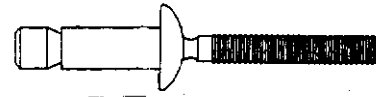

330139-01  
dia. 1/4"  
grip range .080-.375  
stainless steel body  
stainless steel mandrel

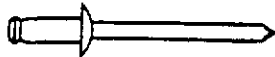

330127-03  
dia. 1/8"  
grip range .063-.125  
aluminum body  
aluminum mandrel



300101  
1/8" I.D.  
washer, aluminum



330127-05  
dia. 1/8"  
grip range .251-.312  
aluminum body  
aluminum mandrel



330137  
dia. 1/8"  
grip range .039-.189  
aluminum body  
steel mandrel

\*Common bolts and screws available at local hardware outlets have not been listed.

# 1998 LAND YACHT 30' & 33'

## \*FASTENERS



320122  
screw, pan head, Phillips  
black  
#4 x 1/8" (glove box tray)



320114-04  
screw wood oval head, Phillips  
antique brass  
#5 x 1/2"



320114-05  
screw wood, oval head, Phillips  
antique brass Phillips stainless steel  
#5 x 5/8"



320115-06  
screw, wood, flat head,  
Phillips stainless steel  
#6 x 1.00"

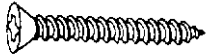

320124-06  
screw, flathead, Phillips  
stainless w/white head

\*Common bolts and screws readily available at local hardware outlets have not been listed.

# 1998 LAND YACHT 30' & 33'

## NOTES

# 1998 LAND YACHT 30' & 33'

## FLOORCOVERING

702793-02	Carpet, Regal/Nautical Blue (Blue Bayou)
702793-01	Carpet, Regal Barley(Peridot)
702793-04	Carpet, Regal Vintage(Alex. Julian)
700173	Carpet padding
702893	Flooring, smooth rubber
702812-02	Flooring, step tread, round black knobs
701538	Carpet, Velour, for storage compartment
201763	Rub strip, storage compartment
381346	Floor mats, cab, drivers or passenger
702549	Mat, entrance, w/Airstream logo
702550	Mat, entrance, step well
801115	Flooring, hardwood, oak
800639-02	Adhesive, hardwood floor
360216	Caulk, brown, acrylic latex

# 1998 LAND YACHT 30' & 33'

## NOTES

# 1998 LAND YACHT 30' & 33'

## FURNITURE

DOORS, INTERIOR		side to side	top to bottom
		Inches	
801157-18	door, raised panel	10.0 x	17.0
801158-08	door frame, for mirror	10.5 x	32.5
801158-11	door frame, for mirror	10.5 x	42.0
801157-09	door, raised panel	11.5 x	15.75
801157-19	door, raised panel	11.5 x	18.0
801158-18	door frame, for mirror	11.5 x	22.0
801157-26	door, raised panel	11.5 x	22.0
801158-06	door frame, for mirror	14.0 x	60.12
801158-16	door frame, for mirror	17.5 x	11.0
800881-05	door, louvered oak	19.0 x	12.5
801158-01	door frame, for mirror	19.0 x	60.12
801158-15	door frame, for mirror	19.5 x	11.5
801157-26	door, raised panel	22.0 x	11.5
801157-12	door, raised panel	31.0 x	11.25
801157-11	door, raised panel	33.0 x	9.75

## MIRRORS

372206-01	mirror, safety	7.62 x	29.62
372206-02	mirror, safety	7.62 x	39.12
372206-03	mirror, safety	8.62 x	14.62
372206-05	mirror, safety	8.62 x	19.12
372207-01	mirror, safety	10.63 x	17.13
372203-19	mirror, safety	11.13 x	22.5
371262-32	mirror, safety	14.0 x	60.12
371262-10	mirror, safety	16.13 x	28.13
372203-14	mirror, safety	21.0 x	22.0

## MISCELLANEOUS DOORS

962782	Door bath swing, 30ft.
961413-02	Door , bath slider, 30ft.
702681-03	Door, foldette, beige, 30ft.
702306-02	Shower door, 30ft.
702306-04	Shower door, 33ft.
961413-04	Door, bath slider 25.5 x 72.0", 33ft.
961413-05	Door, bath slider 34.5 x 72.0", 33ft.

# 1998 LAND YACHT 30' & 33'

## FURNITURE-DRAWER FACE/DRAWER BOX

Inches

801156-85	Drawer face	4.75 x 21.0
801156-23	Drawer face	7.0 x 10.25
801156-13	Drawer face	7.0 x 11.75
801156-14	Drawer face	7.0 x 14.0
801156-87	Drawer face	7.0 x 16.75
801156-48	Drawer face	7.0 x 21.0
801156-84	Drawer face	7.0 x 23.0
801156-82	Drawer face	10.25 x 29.50
801156-01	Drawer face	10.5 x 24.75
801156-77	Drawer face-pantry	10.5 x 36.75
801156-50	Drawer face	11.75 x 20.62
801156-80	Drawer face	14.5 x 15.0
801156-86	Drawer face	16.75 x 16.75
801156-81	Drawer face	20.0 x 14.0

## DRAWER BOXES

962821-01	Drawer box	2.88 x 8.25 x 18.0
962821-03	Drawer box	2.88 x 10.0 x 18.0
962821-25	Drawer box	2.88 x 19.5 x 18.0
962821-06	Drawer box	5.00 x 10.0 x 14.0
962821-05	Drawer box	5.00 x 10.0 x 18.0
962821-09	Drawer box	5.00 x 10.81 x 20.0
962821-31	Drawer box	5.00 x 15.0 x 20.0
962821-08	Drawer box	5.00 x 19.5 x 14.0
962821-07	Drawer box	5.00 x 19.5 x 18.0
962821-40	Drawer box	5.00 x 20.88 x 18.0
962821-04	Drawer box	9.00 x 18.62 x 22.0



# 1998 LAND YACHT 30' & 33'

## FURNITURE-TWIN BEDROOM

963831	Roof locker assy. RS
963832-01	Face frame, RS rear rooflocker
961790	Bed, twin, RS
961792	Headboard, twin, RS-spec. color
963804-02	Roof locker assy., CS
963805-01	Face frame, CS rear roof locker
963892	Bed, twin CS
961793	Head board, twin, CS-spec. color
963835	Roof locker, rear, over window
963837-01	Face frame, rear roof locker
963893	Night stand, center, rear
961779-01	Face frame, rear nightstand
961780	Top, rear nightstand
963894	Wardrobe assy., RS
963611-01	Face frame, RS rear wardrobe
964014	TV cabinet, bedroom, CS

## 1998 LAND YACHT 30' & 33'

### FURNITURE-DOUBLE BEDROOM

963836-01	Roof locker, rear, over window
964430-01	Face frame, rear roof locker
963895-01	Wardrobe assy. rear, RS
962816-01	Face frame, rear RS wardrobe
963895-02	Wardrobe assy., rear, CS
962817-01	Face frame, rear CS wardrobe
963789	Bed, rear double
964071	Mirror assy. corner
9644072	Shelf/facer assy., corner, make-up cabinet.
962666	Top, make-up cabinet
964010-01	TV cabinet, bedroom, rear double

## 1998 LAND YACHT 30' & 33'

### FURNITURE-\*BATH-30'only

962947	Lavy assembly
962956-01	Face frame, lavy assy.
964375-01	Lavy top-Corian
962747-01	Face frame, shower
800880-01	Stile, aft bath panel
203001	Shower stall, fiberglass
203004	Shower stall ceiling liner
702306-02	Shower door, gold
963931-01	Medicine cabinet assy.
962750-01	Face frame, medicine cabinet
961410-01	Jamb, bath door
963426-01	Header, bath door
381563	Track, formed curve, foldette door

\*Note: bath fixtures can be found in hardware-water connected parts in plumbing.

## 1998 LAND YACHT 30' & 33'

### FURNITURE-\*BATH-33'only

963888-01	Lavy assy.
961699-01	Face frame, lavy assy.
964376-01	Lavy top-Corian
962216-01	Face frame, shower
800880-01	Stile, aft bath panel
201957	Shower stall, fiberglass
201960	Shower stall ceiling liner
702306-04	Shower door, gold
963932-01	Medicine cabinet assy.
961927-01	Face frame, medicine cabinet
800894	Header, sliding door, forward
963876	Wardrobe assy., CS
963875-01	Face frame, CS bath wardrobe
801144	Panel, forward, CS wardrobe
963890	Wardrobe assy. RS
961710-01	Face frame, RS bath wardrobe
800886	Panel, aft, RS wardrobe
800887	Panel, forward, RS wardrobe

\*Note: bath fixtures can be found in hardware-water connected parts in plumbing.

# 1998 LAND YACHT 30' & 33'

## FURNITURE-GALLEY-30'only

963925	Refrigerator cabinet assy.
963924-01	Face frame, refrigerator cabinet
963804-01	Roof locker, dinette
963805-01	Face frame, dinette roof locker
962846-01	End cap, dinette roof locker
961040-01	Microwave cabinet assy.
961038-01	Face frame, microwave cabinet
963911-01	Galley cabinet assy.
963910-01	Face frame, galley cabinet
964387-01	Galley top assy.-Corian
964348-01	Sink cover-Corian
963810	Roof locker assy., galley/lounge
964146	Face frame, galley roof locker
962720-03	Table assy., dinette
801070	Table top, oak, w/No mar finish
963654-01	Back splash, dinette table
962981-01	Dinette seat assy., aft
961843-01	Face frame aft dinette seat
961779	Back, upholstered, aft dinette seat
964334-03	Flex spring seat 21.63x38.0
962980-01	Dinette seat assy., forward
962983-01	Face frame, forward dinette seat
962798	Back, upholstered, forward dinette seat
964334-03	Flex spring seat, 21.63 x 32.0

(continued)

# 1998 LAND YACHT 30' & 33'

## FURNITURE-GALLEY-**30'ONLY**

963991	Spice rack
963990	Magazine rack
381491	Trash container, roll out
381577-01	Print, framed
800631	Handrail, oak

# 1998 LAND YACHT 30' & 33'

## FURNITURE-GALLEY-**33'**only

963879	Refrigerator cabinet assy.
963880-01	Face frame, refrigerator cabinet
963896	Roof locker, galley
962843-01	Face frame, galley roof locker
962846-01	End cap, galley roof locker
963619-02	Microwave cabinet assy.
961039-01	Face frame, microwave cabinet
963897	Galley cabinet assy.
963902-01	Face frame, galley cabinet
964384-01	Galley top assy.-Corian
964145	Sink cover-Corian
964147	Roof locker assy., dinette/lounge
964145	Face frame, dinette roof locker
962720-01	Table assy., dinette
801054	Table top, oak, w/No mar finish
963654-02	Back splash, dinette table
963898-03	Dinette seat assy., aft
961711-01	Face frame aft dinette seat
961772	Back, upholstered, aft dinette seat
964334-02	Flex spring seat 21.63x38.0
963898-04	Dinette seat assy., forward
961712-01	Face frame, forward dinette seat
961773	Back, upholstered, forward dinette seat
964334-02	Flex spring seat, 21.63 x 38.0

(continued)

# 1998 LAND YACHT 30' & 33'

## FURNITURE-GALLEY-**33ft. only**

963891	Pantry assy.
961593-01	Face frame, pantry
800889	Panel, aft pantry
963991	Spice rack
963990	Magazine rack
381491	Trash container, roll out
381577-01	Print, framed
800631	Hand rail, oak



# 1998 LAND YACHT 30' & 33'

## FURNITURE-LOUNGE and CAB-**30 FT. ONLY**

963900	End table assy.
961705-01	Face frame, end table
963123	Top, end table
963928	Roof locker, front over head
960482-01	Face frame, front roof locker
963797	Door header cabinet (over main door)
963798-01	Face frame, door header cabinet
800577-13	Trim, decorative , 25 1/4
963801-01	Roof locker, over swivel chair
963802-01	Face frame, roof locker, CS lounge area
964147	Roof locker, over lounge/dinette, RS
964145	Face frame, roof locker over lounge
964045-02	Beverage tray assy.
203011-01	Cup holder, LH
203011-02	Cup holder, RH
960667	End close out assy., lounge
*702801-318	Sofa, jackknife 74", Blue Bayou, w/drawer face
964008	Drawer box, lounge (drawer face comes with lounge)
960668	Arm rest assy., lounge
453368-01	Leg, sofa, 12"
453368-02	Leg, sofa, 8"

\*Number shown is for Blue Bayou-specify other color schemes.

(continued)

# 1998 LAND YACHT 30' & 33'

## FURNITURE-LOUNGE and CAB-**30 FT. ONLY**

960669-02	Close-out, CS, above passenger shoulder
960669-01	Close-out, RS, above drivers shoulder
702897-01	Drivers seat, power
702898-01	Passenger seat, non power
702796	Swivel chair, specify color
452277-01	Pedestal, swivel chair
452277-02	Plate, top pedestal, w/remote

# 1998 LAND YACHT 30' & 33'

## FURNITURE-LOUNGE and CAB-**33** only

963900	End table assy.
961715-01	Face frame, end table
963123	Top, end table
963928	Roof locker, front over head
960482-01	Face frame, front roof locker
963797	Door header cabinet (over main door)
963798-01	Face frame, door header cabinet
800577-13	Trim, decorative , 25 1/4
963801-01	Roof locker, over swivel chair
963802-01	Face frame, roof locker, CS lounge area
964147	Roof locker, over lounge/dinette, RS
964145	Face frame, roof locker over lounge
964045-02	Beverage tray assy.
203011-01	Cup holder, LH
203011-02	Cup holder, RH
960667	End close out assy., lounge
*702801-318	Sofa, jackknife 74", Blue Bayou, w/drawer face
964008	Drawer box, lounge (drawer face comes with lounge)
960668	Arm rest assy., lounge
453626	Sofa leg

\*Number shown is for Blue Bayou-specify other color schemes.

(continued)

# 1998 LAND YACHT 30' & 33'

## FURNITURE-LOUNGE and CAB-**33 only**

960669-02	Close-out, CS, above passenger shoulder
960669-01	Close-out, RS, above drivers shoulder
702897-01	Drivers seat, power
702898-01	Passenger seat, non power
702796-	Swivel chair, specify color
452277-01	Pedestal, swivel chair
452277-02	Plate, top pedestal, w/remote

# 1998 LAND YACHT 30' & 33'

## HARDWARE

### HINGES, CATCHES, LOCKS, PROPS

381428-18	Prop, spring, push-button, front hood
381262	Bracket, prop, w/ball
381109	Bunk latch(slide bolt) , front hood
381481-03	Socket, door, ball prop
385587	Cap, rubber, hood bumper, black
381565-04	Plunger, bolt, assembly, w/o rod collar
452736	Bracket, hood latch pocket
452737	Bracket, pull cable
381484	Strike, compartment door
381327	Cable, hood release
381434	Hinge, stainless steel 3 x 3"
381565-01	Handle assembly, keyed alike, lower comp.
381565-05	Key TM 904
381565-04	Plunger , bolt assy., lower compartment
381456	Cable, coated, handle to plunger
381529	Hinge, lower compartment
381565-02	Handle assy., non locking, lower compartment
381569-03	Spring, gas prop, 40", compartments
381262	Bracket, prop, w/ball
381633	bracket, prop, 2"

# 1998 LAND YACHT 30' & 33'

## HARDWARE

### HINGES, CATCHES, LOCKS, LATCHES, PROPS

#### TRIMARK main door lock

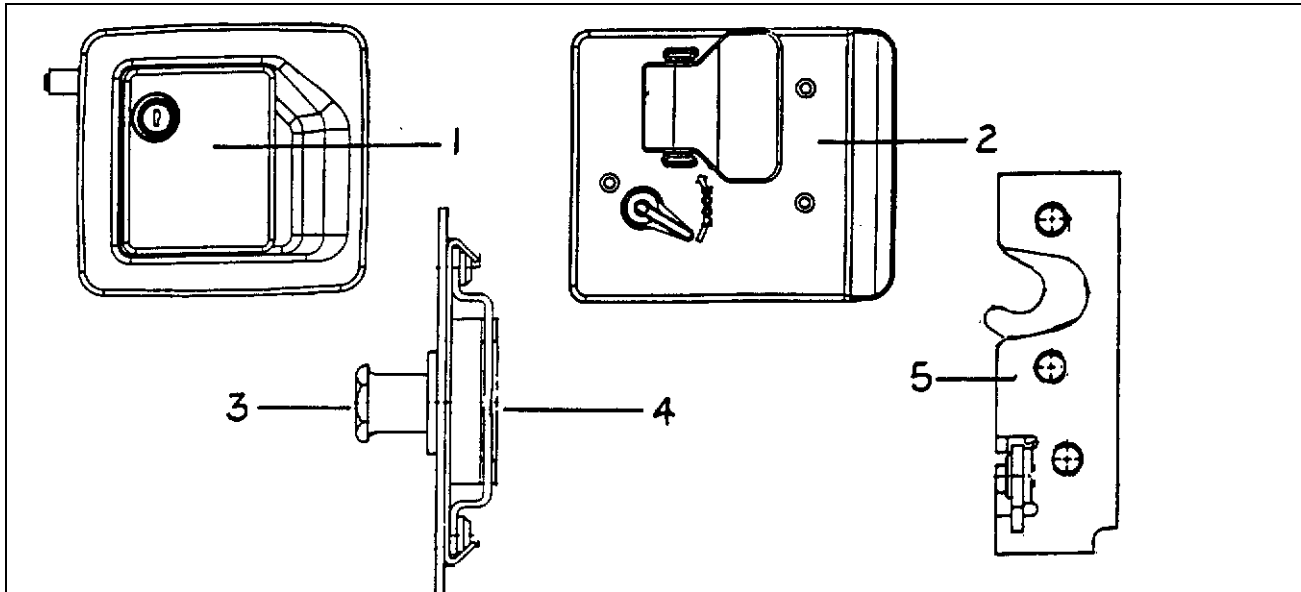

- |              |                           |
|--------------|---------------------------|
| 1) 381521-01 | Outside lock housing      |
| 2) 381521-02 | Inside lock plate         |
| 3) 381284    | Striker bolt              |
| 4) 381521-04 | Caged nut                 |
| 5) 381521-03 | Rotary latch              |
| 381521-05    | Screws, inside lock plate |

#### Dead bolt-Trimark

- |           |                                    |
|-----------|------------------------------------|
| 510802-01 | Actuator, door lock, 5-wire        |
| 381323-01 | Dead bolt assembly                 |
| 452030    | Bolt, Trimark dead bolt            |
| 381326    | Striker, 10007 w/Trimark dead bolt |
| 345321-12 | Screw, #8-32, flat head, black     |
| 200772    | Pan, plastic, dead bolt, interior  |

# 1998 LAND YACHT 30' & 33'

## HARDWARE

### TRIMARK drivers door lock

381285	Housing and black paddle, exterior
195293-08	Bezel and lever assy., inside
195293-01	Latch and linkage w/override and unlock
381381	Rod, inside release lock
381382	Rod, inside release latch
381391	Rod, outside release latch
381284	Striker bolt-Trimark
195293-12	Rod end clip, LH
195293-11	Rod end clip, RH
510802-01	Actuator, door lock, 5-wire Acme
381394	Hinge leaf, jamb, driver door
381393	Hinge leaf, driver door
310024-01	Hinge pin 8"
381334	Hinge leaf , jamb, main door
381377	Hinge leaf, door
381377	Hinge leaf , screen door
385599-075	Bearing, sleeve, hinge
310024	Pin, hinge .250 x 6"
300118-01	Washer, nylon, main door hinge
381427	Hold back , main door
380004	Handle, screen door
511370-02	Grab handle-embossed" Land Yacht"
114224	Plunger rear ladder, bottom attachment
381148-01	Socket, rear ladder, bottom support

# 1998 LAND YACHT 30' & 33'

## HARDWARE

### HINGES, CATCHES, LOCKS, PROPS

381526-06	Rear bracket, adjustable, drawer slides
381526-01	Drawer slide, 14" roller type
381526-03	Drawer slide 18" roller type
381526-04	Drawer slide, 20" roller type
381526-05	Drawer slide, 22" roller type
381400-01	Drawer slide, 12" ball bearing type
381400	Drawer slide, 14" ball bearing type
381090	Drawer slide, 22" ball bearing type
381601	Hinge, cabinet, Antique Brass
380210	Hinge, plain steel
380284-02	Hinge bracket, dinette table
380458	Hinge, piano, brown, 5/8" leaf
380203-01	Hinge, piano, clear anodized, 1/8" pin
381175	Pull handle, wood
381599	Handles, brass, drawer/door
381603	Pull three finger, sliding door
381443-01	Sliding door set, includes carriers, top door plates, and track
381074	Bulldog catch, set
381228	Grabber door catch, set
*381385	Dual lock #400-1" strips
*381386	Dual lock #170-1" strips

\*These two



## 1998 LAND YACHT 30' & 33'

### HINGES, CATCHES, LOCKS, PROPS

385940	Mirror pull, brass
385935	Hinge, pivoting, brass, used on mirrors
452358	Catch, glove box latch
381438	Latch, glove box, squeeze
381442	Retainer clip, glove box latch
381437	Hinge, glove box
381109	Bunk latch, pantry
381408	Latch, push button, black, pantry
381147	Door support, spring loaded, roof locker
385963	Bracket, mounting angle, lambrequin
381612	Mirror clip, wood framed doors
380046	Flange, chrome, clothes rod support
380045	Tubing 3/4" metal, clothes rod
200975-04	Conduit, flexible, -black, covers clothes rod
381449-04	Rail, decorative rod, center rear roof locker
381449-05	Post, decorative rod, center rear roof locker
380034	Toilet paper holder, chrome
381626-02	Towel bar, 18", chrome and brass
380017	Tooth brush/tumbler holder

# 1998 LAND YACHT 30' & 33'

## HARDWARE

### HINGES, CATCHES, LOCKS, LATCHES, PROPS



36012 Bumper, rubber  
white, stick-on, cylindrical

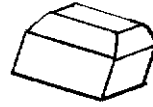

360016 Bumper rubber  
gray, square 3/8x3/8

360012-01 Bumper, rubber  
brown, stick-on, cylindrical



195329-220 Bumper, rubber  
clear, stick-on oval



385587 Cap, rubber  
hood bumper, black

381242-01 Bracket, shelf, vertical, 30", rear wardrobe  
381243 Clip, shelf support, rear wardrobe  
381527 Speedy shelf strip

453453 Bracket , bedroom TV shelf  
381220-01 Mirror clip, nickel plated #318  
381220-02 Mirror clip, nickel plated #309

381067-09 Prop, gas, 90#-twin bed  
381262 Bracket, prop, w/ball-angle  
381085 Clip, retaining, gas prop bracket

# 1998 LAND YACHT 30' & 33'

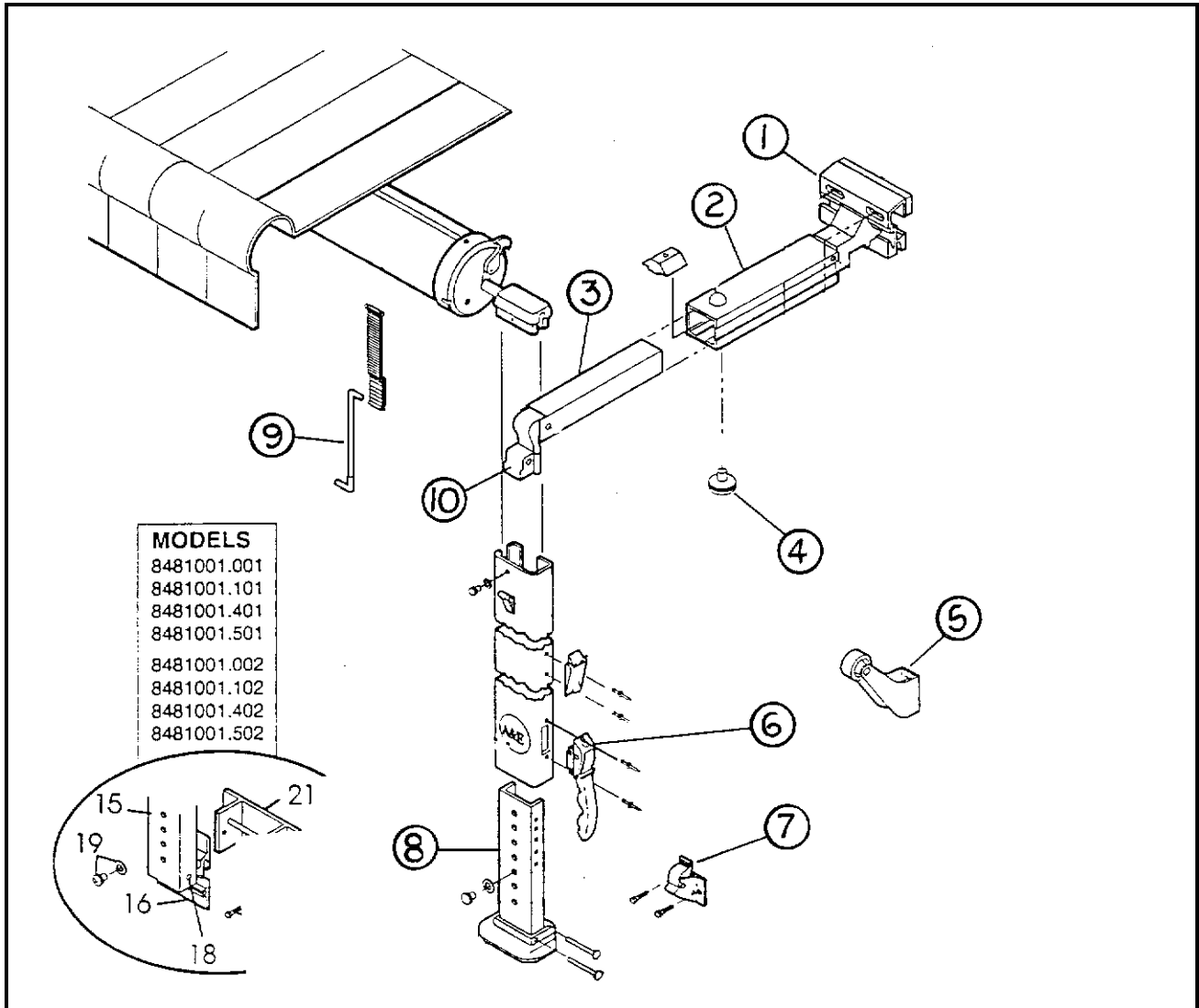

- |                |                                      |
|----------------|--------------------------------------|
| 1) 702679-104  | Bracket top, A&E awning              |
| 2) 702679-111  | Rafter, main, A&E awning             |
| 3) 702679-105  | Secondary rafter, A&E awning         |
| 4) 702679-106  | Knob, adjustment, 1 7/8" A&E awning  |
| 5) 702679-109  | Door roller, A&E awning              |
| 6) 702679-103  | Lift handle, A&E awning              |
| 7) 702679-108  | Bracket, bottom mounting, A&E awning |
| 8) 702679-107  | Arm, adjustable, A&E awning          |
| 9) 702679-102  | E-Z pull rod, A&E awning             |
| 10) 702679-110 | Slider assembly, A&E awning          |



# 1998 LAND YACHT 30' & 33'

## SECTION IV

L through Z

LABELS and TAGS ..... IV-1

OPTIONS ..... IV-3

### PLUMBING

LPG ..... IV-5

Fresh water ..... IV-6

Drain water ..... IV-12

Toilet ..... IV-15

SAFETY EQUIPMENT ..... IV-17

### SEALS/SEALER/PAINT

Gaskets ..... IV-19

Sealer ..... IV-23

Adhesive ..... IV-24

Paint ..... IV-24

### UPHOLSTERY/FOAM/MATTRESS

Mattresses ..... IV-25

Bed spread ..... IV-25

Cab/Swivel seat ..... IV-25

Dinette foam/upholstery, 30ft. .... IV-26

Dinette foam/upholstery, 33ft. .... IV-26

### VENTS/FANS

Skylights ..... IV-27

Vents ..... IV-27

Fans ..... IV-27

### WOOD/LAMINATES/INTERIOR TRIM

Paneling ..... IV-29

Wood accessories ..... IV-29

Wood molding/trim ..... IV-30

Ceiling trim/retainer ..... IV-31



# 1998 LAND YACHT 30' & 33'

## LABELS AND TAGS

385103	Plate,RVIA
385531	FMVSS certification label
385815	Name plate,motorhome hitch rating
385095	Tag registry #11999
385465	Label,exit warning (English)
385463	Label,warning label/cooking appliance
385464	Label,LP gas warning label (odor)
385788	Warning label,pilot light/refuel
385101	Tag,auxiliary tank dump valve handle
385099	Tag,black tank dump valve handle
385063	Label,drain cap
385062	Decal,110-125 voltage AC
385309	Decal,fuel fill
385547	LP gas warning/fill label
385141	Tag,seat,clear w/black letters
385518	Label,dimension and clearance
385193	Label,12Volt distribution inside
385560	Air conditioner rating label
385561	Generator rating label
385565	Label,holding tank flushing
385805-01	A/C priority switch label-front
385805-02	A/C priority switch label-rear
385812	Label,Calif. hazardous substance
385609	Label,smoke detector
385612	Label, parking brake warning
385829	Decal,fuse and relay
385828	Decal, fuse panel warning
385851	Label,cellular phone
385924	Label, galley light

(continued)

# 1998 LAND YACHT 30' & 33'

## LABELS AND TAGS

- 385933 Label, name set relay
- 385941 Label, waste water holding
- 385942 Label, sewage holding tank
- 385943 Label, "cap must be in place"
- 385947 Label, 10 amp fuse maximum
- 385608 Label, sewer hose L/Y M/H
- 385615 Label, fuse block L/Y M/H
- 385917 Decal, oak table w/no mar finish
- 385949 Label, "potable water" CSA
- 385950 Label, "smoke detector" CSA
- 385951 Label, "range fresh air" CSA
- 385952 Label, "LP warning" CSA
- 385953 Label, "If you smell gas" CSA
- 385954 Label, "range warning" CSA
- 385466 Label, exit label (French)
- 385620 Label, unleaded fuel only
- 385835 Label, carburetor warning
- 385098 Label, seat occupancy



# 1998 LAND YACHT 30' & 33'

## OPTIONS Defroster fan

511376 Fan, defrost, oscillating  
510929-05 Switch, dash  
510930-35 Lens, dash switch-defrost fan

## 50 Amp service

511149-03 Power cord, 50amp , 36ft.  
51149-02 Power inlet with strain relief, 50 amp  
510562-03 Switch, auto transfer, 50 amp  
510723 Breaker box  
510724 Breaker, double pole, 50 amp  
510562 Switch, generator switch over

## Video upgrade

690337 Video cassette player-Audio Vox  
511310 Video control center

## Skylights

203153-01 Skylight, 22 x 22 clear, galley  
203152-02 Trim, skylight 22 x 22  
702804-02 Pleated shade, skylight 20.25 x 21.0  
  
203148-01 Skylight, heavy duty, shower, 14.5 x 22.5  
203148-02 Trim inner, skylight 14.0 x 22.0  
  
203153-01 Skylight, bath, 14 x 22  
203152-01 Trim inner, skylight 14 x 22  
702804-02 Pleated shade, skylight, 20.25 x 21.0

# 1998 LAND YACHT 30' & 33'

## OPTIONS

### Fantastic fan

381564 Vent w/wall thermostat, Fantastic 2000TRS

### Invertors

511340 Invertors, 130 watt, (operates front TV only)

511278 Lock-out, 110 volt disconnect

### Refrigerator

690370-03 Refrigerator, 2-way, 3862 w/ice maker

### Passenger seat

702897-02 Cab seat, passenger, power, Wayfarer

### Back-up monitor

510918-01 Monitor, Sony watchman

453030 Bracket, camera

452667 Bracket, monitor

203029 Mounting, inner, rear camera

203030 Cover, outer, rear monitor

511044-03 Actuator, push/pull, two position, rear camera

511044-04 Pigtail, two position camera actuator

### Hardwood floor

801115 Flooring, hardwood , oak

800639-02 Adhesive, hardwood floor

360216 Caulk, brown, acrylic latex

### Oven

690347 Range, 3-burner w/oven

# 1998 LAND YACHT 30' & 33'

## PLUMBING-LPG

601500	LP tank, 105# w/90 ohm sender-33' only
601447	LP tank, 90# w/90 ohm sender-30" only
511229	Sending unit, 90 ohm, Snap On
943433	Vapor line
601335	LP hose, tank to regulator, 35"
600293	Close nipple, 1/2" NPT, brass
601408	Elbow, 90 degree, 1/2 NPT
601409	"T", 1/2 NPT
601674	Regulator, 2 stage
203135	Cover, regulator
601673-01	Hose 3/8"x48", low pressure
601675	Union, 3/8 M FL x 3/8 m NPT
600000	"T", 5/8 x 5/8 x 3/8, brass
600003	"T", 5/8 x 3/8 x 3/8, brass
600436	Flare nut, forged 5/8
600435	Flare nut, forged 3/8

# 1998 LAND YACHT 30' & 33'

## PLUMBING-FRESH WATER

- 601552 Tank, fresh water, 60gal.  
201866-02 City water fill, polar white  
601197-01 Water hook-up, chrome  
601239 Tubing, ribbed, 1.375 I.D., water fill
- 601061-01 Water pump, Shurflo  
601668 Filter, pre water pump

### FITTINGS

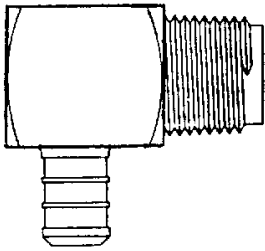

601698-04  
Elbow, 1/2 barb  
x 1/2 MPT

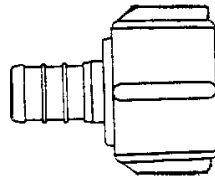

601698-03  
Coupler, 1/2 barb  
x 1/2 FPT

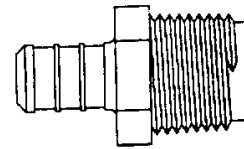

601698-02  
Coupler, 1/2 barb  
x 1/2 MPT

(continued)

# 1998 LAND YACHT 30' & 33'

## PLUMBING

### FRESH WATER

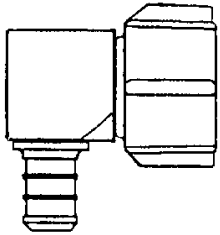

601698-05  
Elbow 1/2 barb x  
1/2 FPT

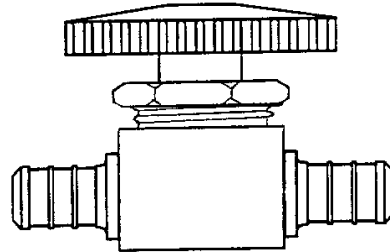

601698-07  
Shut-off, 1/2 barb x  
1/2 barb

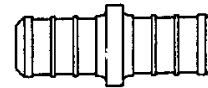

601698-08  
Coupler  
1/2 x 1/2 barb

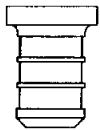

601698-09  
Plug, 1/2 barb

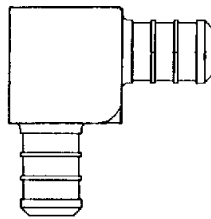

601698-10  
Elbow 1/2 barb x  
1/2 barb

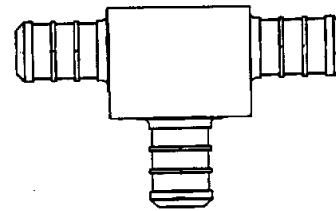

601698-11  
Tee, 1/2 x 1/2 x  
1/2 barb



601698-15  
Crimp ring, 1/2  
E-Pex, 1/2 (black)



601698-01  
E-Pex tube, 1/2"

# 1998 LAND YACHT 30' & 33'

## PLUMBING-FAUCETS

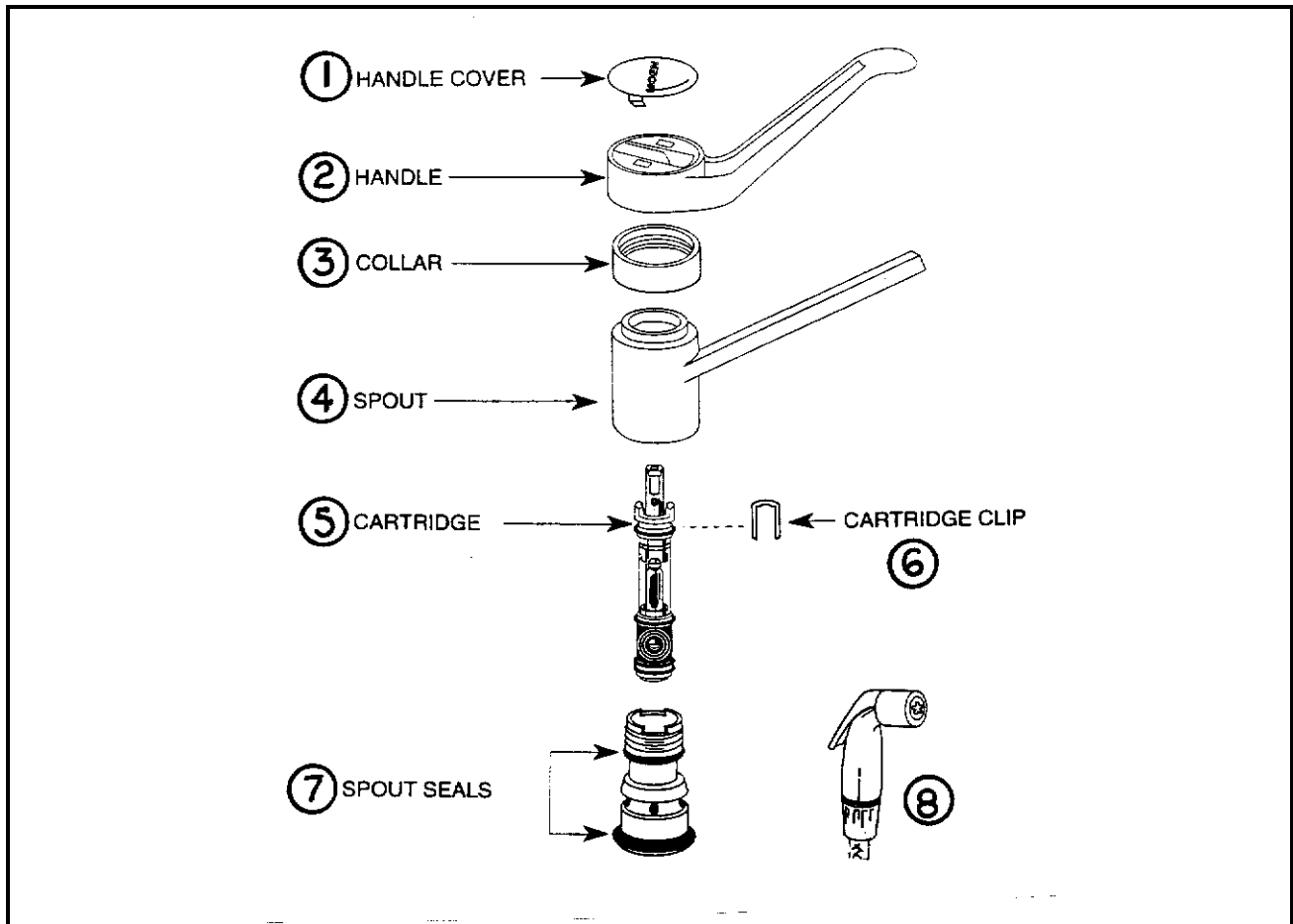

### 601705 FAUCET, GALLEY, MOEN #7215S

- |               |                                |
|---------------|--------------------------------|
| 1) 601705-972 | Handle cover, sand             |
| 2) 601705-444 | Handle, sand                   |
| 3) 601705-694 | Collar, sand                   |
| 4) 601705-915 | Spout, sand                    |
| 5) 601579-106 | Cartridge, Moen                |
| 6) 601579-105 | Clip, cartridge retainer       |
| 7) 601705-117 | Spout seals, Moen 7215S        |
| 8) 601705-873 | Spray head/hose assembly, sand |

# 1998 LAND YACHT 30' & 33'

## PLUMBING-FAUCETS

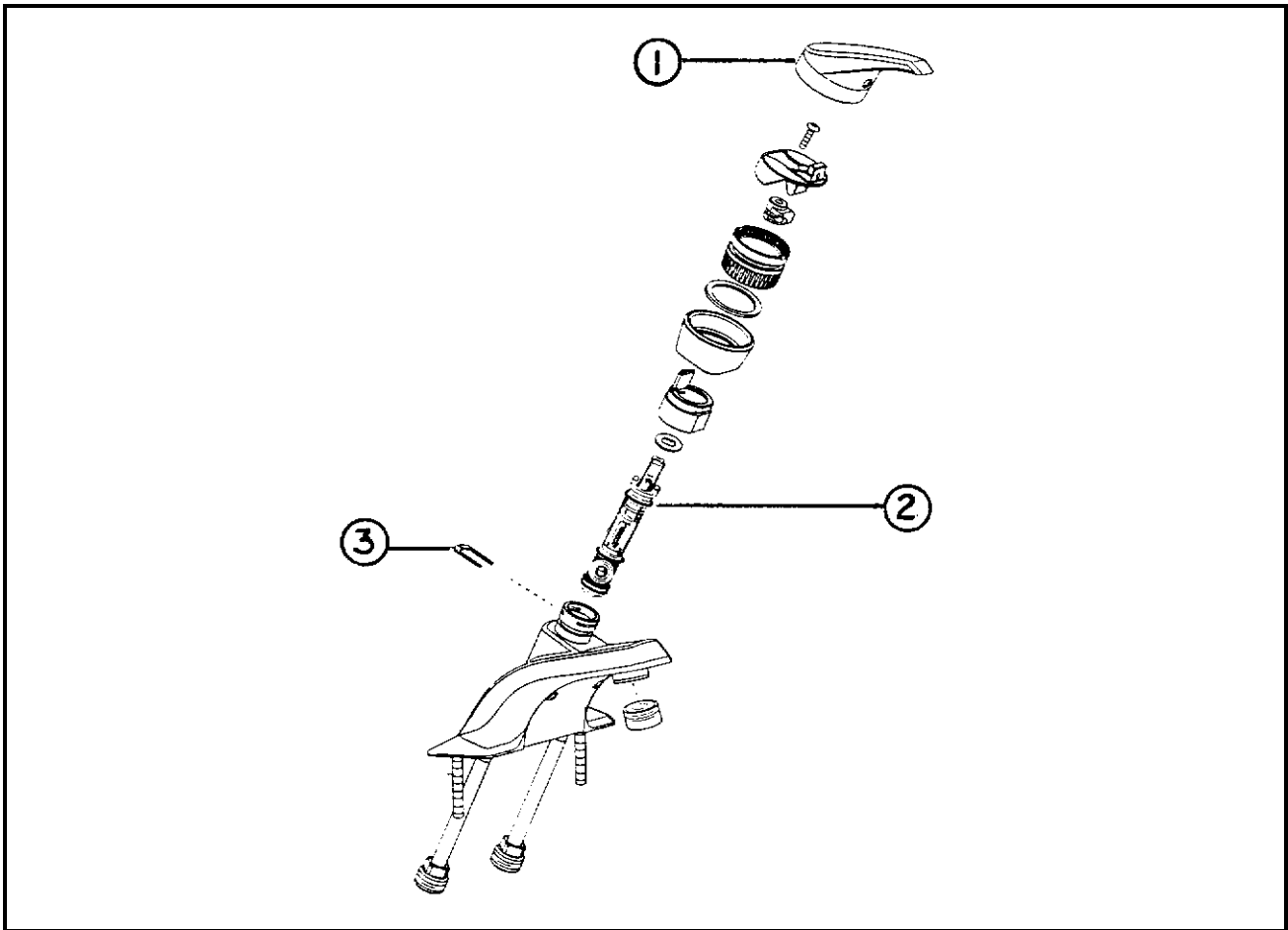

690390-02      Faucet, lavatory, Moen, brass/chrome

- 1) 690390-100      Lever handle
- 2) 601579-105      Cartridge
- 3) 601579-104      Retainer clip

# 1998 LAND YACHT 30' & 33'

## PLUMBING-FAUCETS

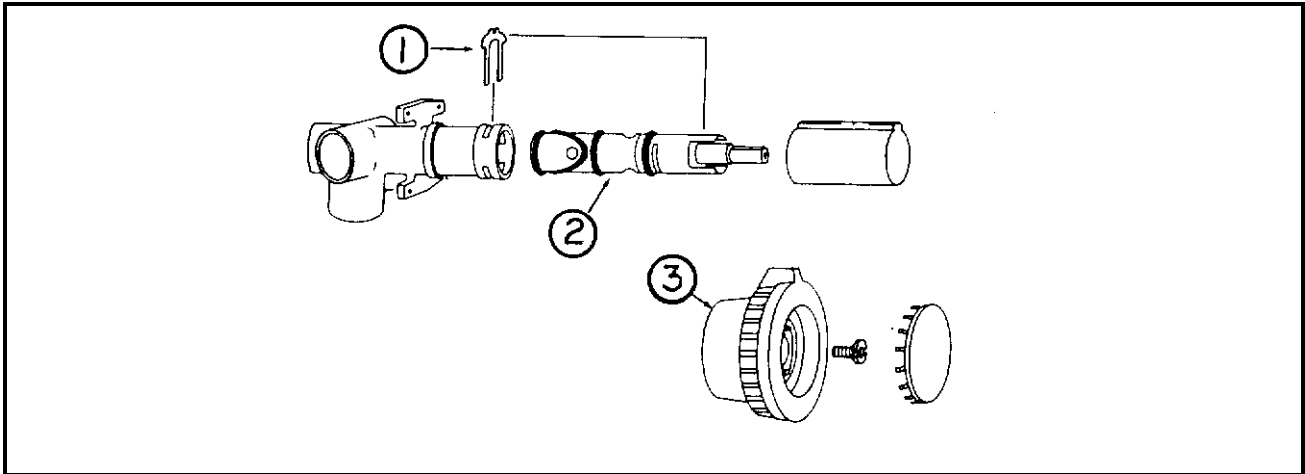

601420-02Faucet, shower

- |               |               |
|---------------|---------------|
| 1) 000883     | Retainer clip |
| 2) 601420-100 | Cartridge     |
| 3) 001041     | Handle        |

- |            |                        |
|------------|------------------------|
| 601358-100 | Shower head , chrome   |
| 600330     | Shower hose, chrome    |
| 600332     | Vacuum breaker, chrome |



# 1998 LAND YACHT 30' & 33'

## PLUMBING

### FRESH WATER

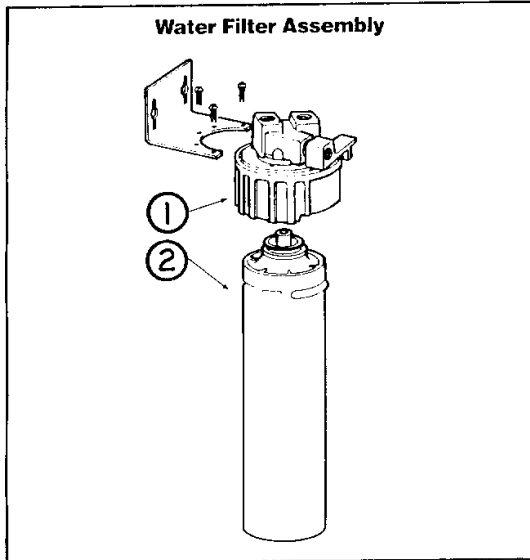

- 1) 005273 Head, water filter
- 2) 960112 Cartridge, filter

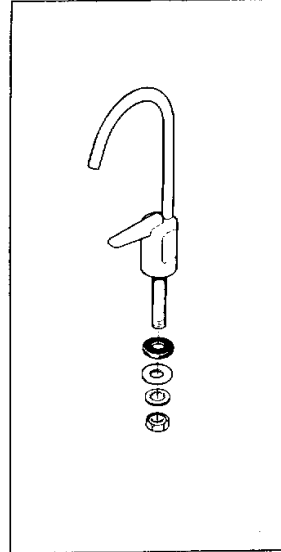

601401 Faucet, water

# 1998 LAND YACHT 30' & 33'

## PLUMBING-DRAINAGE

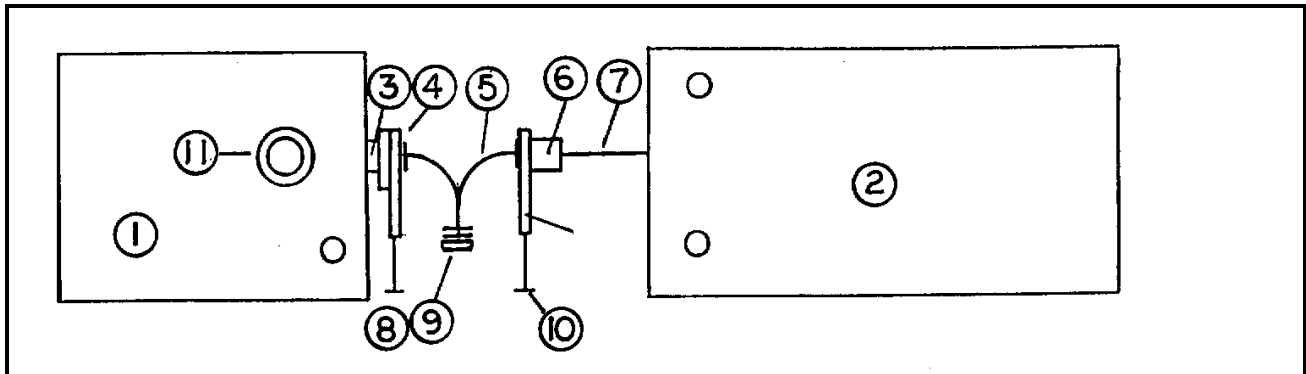

- |              |                            |
|--------------|----------------------------|
| 1) 601493    | Holding tank, black, 33ft. |
| 1a) 601567   | Holding tank, black, 30ft. |
| 2) 601492    | Holding tank, gray         |
| 3) 601432    | Adaptor, valve to tank     |
| 4) 601430    | Gate valve, 3inch          |
| 5) 600866    | "T" long sweep             |
| 6) 600289    | Coupler, 3 inch            |
| 7) 601160-04 | Pipe, drain, 3" plastic    |
| 8) 601251    | Bayonet ring, glue on      |
| 9) 601250    | Bayonet cap                |
| 10) 601519   | "T" handle                 |
| 11) 601266   | Closet flange, 4x3         |

601441 Tank flush system, NO-FUSS

914190 Pan, black tank

914191 Pan, gray tank

# 1998 LAND YACHT 30' & 33'

## PLUMBING-DRAINAGE

201957	Shower stall, fiberglass
601362-02	Tip toe stopper, shower drain
200406-06	Lavy bowl, oval-includes tail, basket and stopper
601497-01	Sink, galley, porcelain almond
195362-39	Basket, galley sink, 2 inch
600378	Continuous waste, 1.5", galley drain
601160-02	Pipe, drain, plastic 1.5"
601160-04	Pipe, drain, plastic, 3.0"
600182	Wye, 1.5 x 1.5 x 1.5, drain line
600431	Elbow, street, 1.5", 90 degree
600144	"P" trap, 1.5"
601318	"T", bi-directional cleanout, 1.5"
600538	Vent, automatic, V-200
600622	"P" trap-w/slip nut & washer, 1.5"
600625-01	Trap plug adapter, 1.5"
600625-02	Plug, tray adapter, male, 1.5"
600622	Elbow, long sweep, 90 degree, 1.5"
600094	Wye, 45 degree, 1.5"
600156	"T", sanitary, 1.5x1.5x1.5"
600662	Elbow, short sweep, 1.5"
600030	Elbow, 45 degree, 1.5"
600033	Elbow, 90 degree, short, 1.5"

# 1998 LAND YACHT 30' & 33'

## PLUMBING

THETFORD, AQUA MAGIC GALAXY , FOOT FLUSH, PARCHMENT

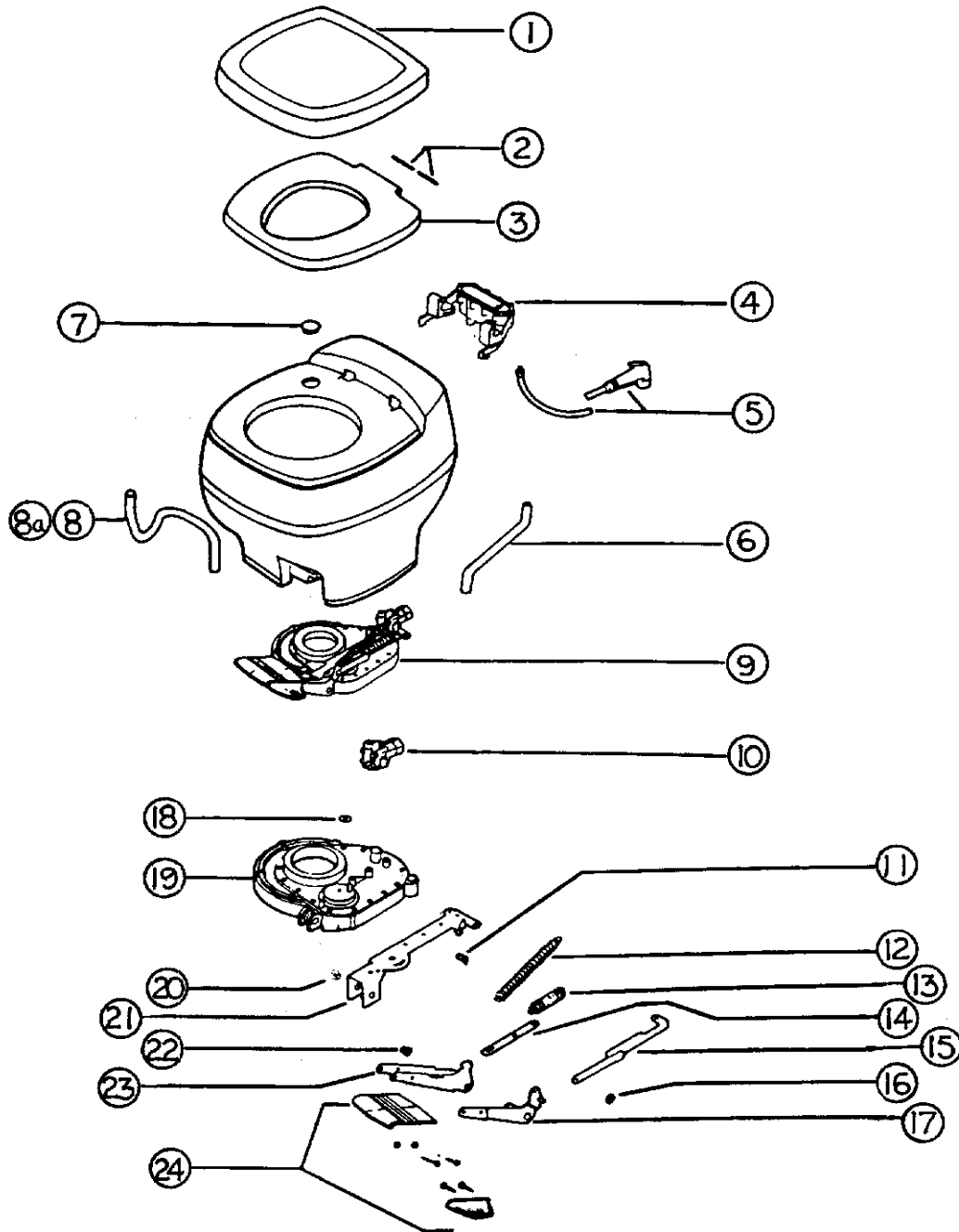

# 1998 LAND YACHT 30' & 33'

## PLUMBING

THETFORD, AQUA MAGIC GALAXY, PARCHMENT

- 690327-01 Toilet complete, Aqua Magic Galaxy, low
- 1) 020925 Padded seat cover, parchment
  - 2) 012986 Hinge pin
  - 3) 1626457 Seat, parchment
  - 4) 008217 Vacuum breaker w/water saver, parchment
  - 5) 008993 Water saver package
  - 6) 003728 Water supply tube
  - 7) 003895 Hole plug, parchment
  - 8) 003729 Trap tube, 20", low style
  - 8a) 003727 Trap tube, 27", high style
  - 9) 024203 Mechanism, parchment
  - 10) 009868 Ball valve replacement package
  - 11) 002391 Drive arm assembly
  - 12) 002802 Spring, ball valve return
  - 13) 002801 Spring
  - 14) 008986 Push link
  - 15) 002796 Drive arm
  - 16) 002394 Ring, retainer
  - 17) 009421 Pedal arm assembly
  - 18) 008034 Retainer ring, 1/4"
  - 19) 020929 Base and cover assembly
  - 20) 003749 Bushing, mechanism
  - 21) 012593 Lever plate
  - 22) 003749 Bushing, mechanism
  - 23) 019266 Pedal arm
  - 24) 020930 Double pedal package

# 1998 LAND YACHT 30' & 33'

## NOTES

# 1998 LAND YACHT 30' & 33'

## SAFETY EQUIPMENT

510781	Detector, smoke #1056 w/silencer
511343	Detector, carbon monoxide-9 volt
511309	Detector, LPG
510734	Alarm, back-up
381069	Seat belt kit, dinette
700349	Seat belt, lounge/cocktail chair
690381-01	Fire extinguisher 10 B: CUL
690381-02	Fire extinguisher 10 B: CULC (Canadian)
380188	Emergency warning triangle, set of 3

# 1998 LAND YACHT 30' & 33'

## NOTES



# 1998 LAND YACHT 30' & 33'

## SEALS-GASKETS



1) 365205



2) 365237-01



3) 365232



4) 365208



5) 201260

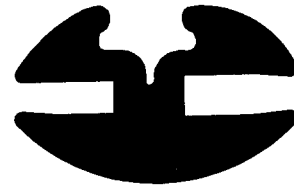

6) 381319



7) 365013-01

1) 365005

Gasket, weather strip, rear trunk door

2) 365237-01

Seal, dust, compartment door edge (replaced 365208 mid 98 model)

3) 365232

Seal, main door/compartment door jamb

4) 365208

Gasket, seal-compartment door hinge and window to body

5) 201260

Insert, windshield gasket, rubber

6) 381319

Gasket, windshield, includes center strip

7) 365013-01

Gasket, screen door, low density foam

# 1998 LAND YACHT 30' & 33'

## SEAL-CREATION GASKETS



1) 371593-711



2) 371593-337



3) 371593-324



4) 371593-331



5) 371593-315



6) 371593-633

1) 371593-711

Glazing rubber, Creative

2) 371593-337

Stationary rubber, Creative

3) 371593-324

Post wipe seal, Creative

4) 371593-331

"U" channel, Creative

5) 371593-315

Bottom seal, Creative

6) 371593-633

Slider rubber, Creative

# 1998 LAND YACHT 30' & 33'

## SEAL-CREATION GASKETS



1) 371593-316



2) 371593-714



3) 371593-346



4) 371593-325



5) 371593-004



6) 371593-312

1) 371593-316

Pocket cover, Creative

2) 371593-714

Top vent seal, Creative

3) 371593-346

Vent seal, Creative

4) 371593-325

Sliding glass track, Creative

5) 371593-004

T-Spline for screen, Creative

6) 371593-312

Vent head/post seal, Creative

# 1998 LAND YACHT 30' & 33'

## SEAL- CREATION GASKETS



1) 371593-302



2) 371593-074



3) 371593-121



4) 371593-348

1) 371593-302

Sliding screen stop, Creative

2) 371593-074

Post glazing vinyl, Creative

3) 371593-121

Bug flap, Creative

4) 371593-348

Channel dress, Creative

# 1998 LAND YACHT 30' & 33'

## SEALS-SEALER

### SEALER

360209-01	Sealer, black, #5507
360281	Sealant, thermoplastic, clear
360268-01	Liqua Seal, roof, white
685510	Seam tape, black
360216	Caulk, latex, brown
365001	Tape, double coated foam
360074	Sealant, GE RTV, white
360001	Butyl sealent#884058
360002	Vulkem sealant, gray
360176	Sealant, almond, bathroom
360210	Sealant, paralastic #4334-04 (refrigerator compartment sealer)
360180	Sikaflex, 221 adhesive/sealant
360052	Vulkem seal , black
360283	Silicone sealer, Corian bone
360286	Sealant, gray, SU-6000

# 1998 LAND YACHT 30' & 33'

## SEALS-ADHESIVES/PAINT/MISC.

### ADHESIVES

601704-01	Corian glue, Bisque
800639-02	Adhesive, oak plank flooring
360270	Adhesive spray, Sta-put, ceiling panels (reference only, not available for shipment)

### PAINT

360260	Paint, Pewter lower-lower skirts, Centari
360262	Paint, Nu-white-side walls, Centari
360234	Paint, Grey Smoke, Delstar
360208	Stain, medium oak
365244	Lacquer, clear, used on wood

### MISCELLANEOUS

360179	Undercoat, Pennzoil II
6000329	Tape, silver, 2" wide
200518	Spline, gray, screen insert
380079	Screen, gray



# 1998 LAND YACHT 30' & 33'

## UPHOLSTERY/FOAM/MATTRESS

### DINETTE UPHOLSTERY , 30FT. MODEL

702464-01	Foam, dinette, upper back, RH
702464-02	Foam, dinette, upper back, LH
702464-06	Foam, dinette, lower, both sides
702464-08	Foam, dinette seat, aft
702464-10	Foam, dinette seat, forward
<hr/>	
964334-03	Flex spring seat, dinette, 21.63 x 32.0
998070	Seat cover, side dinette
998071	Back cover, dinette
962799	Back, upholstered dinette seat , aft
962798	Back, upholstered dinette seat, forward

### DINETTE UPHOLSTERY 33FT.MODEL

702464-03	Foam, dinette, upper back, RH
702464-04	Foam, dinette, upper back, LH
702464-07	Foam, dinette, lower, both sides
702464-09	Foam, dinette seat, aft
702464-11	Foam, dinette seat, forward
<hr/>	
964334-02	Flex spring seat, dinette, 21.63 x 38.0
998070	Seat cover, side dinette
998071	Back cover, dinette
961772	Back, upholstered dinette seat , aft
961773	Back, upholstered dinette seat, forward



# 1998 LAND YACHT 30' & 33'

## VENTS/FANS

### Skylights

203153-01	Skylight, 22 x 22 clear, galley
203152-02	Trim, skylight 22 x 22
702804-02	Pleated shade, skylight 20.25 x 21.0
203148-01	Skylight, heavy duty, shower, 14.5 x 22.5
203148-02	Trim inner, skylight 14.0 x 22.0
203153-02	Skylight, bath, 14 x 22
203152-01	Trim inner, skylight 14 x 22
702804-02	Pleated shade, skylight, 20.25 x 21.0

### Roof vents

381564	Vent w/wall thermostat, Fantastic 2000TRS
381153-01	Vent, Jensen #757
381153-100	Screen, Jensen #757 vent
381207-03	Vent, refrigerator, roof w/screen
511376	Fan, defrost, oscillating
511152-11	Range hood w/monitor, black
511152-01	Vent, range hood, exterior, white
690266-01	Ventilator, power, 30ft. bath

1998 LAND YACHT 30' & 33'

NOTES

1998 LAND YACHT 30' & 33'  
WOOD/LAMINATES/INTERIOR TRIM

800397-01	Cedar, planked, 5/32" x 4' x 8'
201728-01	Extrusion, ceiling trim retainer
201728-04	Extrusion, ceiling trim
800542-02	Structure wood 3/8" x 4' x 8'
800542-03	Structure wood 1/2" x 4' x 8'
800542-04	Structure wood 5/8" x 4' x 8'
800507-01	Paneling, luan 1/8" x 4' x 8'
800507-02	Paneling, luan 1/4" x 4' x 8'
800507-03	Paneling, luan 3/8" x 4' x 8'
801176-03	Paneling, interior wall, 1/8 x 4' x 7', Solitude
801177-01	Paneling 1/2" x 4' x 8', G2S, solitude/solitude
801185-01	Paneling 1/2" x 4' x 8', G1S, solitude/raw
801233-01	Paneling 1/4" x 4' x 8', G1S, solitude/raw
801183-01	Paneling, 1/2" x 4' x 8', G2S, oak/solitude
801180	Paneling 1/2" x 4' x 8', G2S, oak/oak
801179	Paneling, 1/2" x 4' x 8', G1S, oak/raw
801182	Paneling 5/32" x 4' x 8', G2S, oak/oak
801181	Paneling 5/32" x 4' x 8', G1S, oak/raw
801230	Laminate, oak, 4' x 8'
800631	Handrail, oak, 23"
963990	Magazine rack
801115	Flooring, oak quartered 3/8"

# 1998 LAND YACHT 30' & 33'

## WOOD/LAMINATES/INTERIOR TRIM



1) 801206-01



2) 964152-01

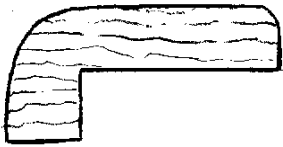

3) 964280



4) 800571-01



5) 800617-01

1) 801206-01

Molding, floor, oak, 43"

2) 964152-01

Molding, chair rail, oak

3) 964280

Molding, top edge counter (hot glue

application.)

4) 800571-01

Molding, oak, flat 1/4" x 33/64" x 80"

5) 800617-01

Molding, wainscoat, oak

(Not shown)

801172-01

Molding, corner, oak

801173-03

Molding, flat radius, .88 oak

800575-01

Molding, corner, oak

# 1998 LAND YACHT 30' & 33'

## WOOD/LAMINATES/INTERIOR TRIM

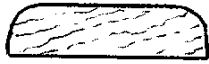

1) 800573-01



2) 800572-01



3) 201728-04

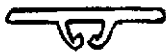

4) 201728-01



5) 203159-01

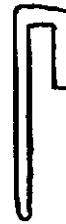

6) 201666

1) 800573-01

Molding, door edge 1 3/32 x 80"

2) 800572-01

Molding, panel edge, oak 23/32 x 80"

3) 201728-04

E x trusion, ceiling trim

4) 201728-01

Extrusion, ceiling trim retainer

5) 203159-01

Trim, divider bar, interior panels, Solitude

6) 201666

Molding , J 3/16, plastic

# 1998 LAND YACHT 30' & 33'

## NOTES



