

AIRSTREAM

**350/355
XL**

**2000
Parts Book**



2000 350/355 XL LAND YACHT

TABLE OF CONTENTS SECTION I

A through C

APPLIANCES

Air conditioner	I-1
Furnace	I-1
Microwave	I-1
Range	I-2
Refrigerator	I-2
Water heater	I-3

BODY

CS wall	I-5
RS wall	I-7
Slide out extrusions	I-8
Slide out gaskets	I-9
Front end	I-11
Aft end	I-13
Roof	I-14

CHASSIS

Hitch	I-15
Power jacks	I-15
Step	I-15
Automotive air conditioner	I-16
Auxiliary heater	I-16

2000 350/355 XL LAND YACHT

SECTION II D through E

DASH

[Dash parts](#)..... II-1

[DECALS](#)..... II-3

DOORS/WINDOWS/AWNINGS

[Roadside](#) II-7

[Curbside](#)..... II-9

[Main door](#)..... II-11

[DRAPES/BLINDS/VALANCES](#) II-12

ELECTRICAL

[110 volt](#) II-13

[12-volt, chassis](#) II-15

[Dash switches/lens](#) II-17

[12-volt interior switches](#) II-18

[12-volt interior lights](#)..... II-18

[12-volt exterior lights](#)..... II-20

[12-volt-mics.](#) II-21

[Windshield-wiper-assy.](#)..... II-23

ENTERTAINMENT

[Televisions](#)..... II-24

[Radios](#)..... II-24

[Rearview-monitor](#) II-25

2000 350/355 XL LAND YACHT

SECTION III F through H

FASTENERS

(Common fasteners available locally are not listed)

Rivets	III-1
Screws	III-3

FLOOR COVERING

Carpet	III-4
Hardwood flooring	III-4
Mats	III-4

FURNITURE

Interior doors	III-5
Mirrors	III-6
Drawer face	III-6
Drawer box	III-6
Bedroom furniture w/slide	III-7
Bedroom non-slide	III-9
Bath area	III-10
Galley, slide-out	III-11
Cab and lounge, slide-out	III-13

HARDWARE

Exterior locks	III-15
Main door/screen door	III-16
Exterior lower compartment	III-18
Slide-out room	III-20
Awning hardware	III-22
Interior hardware	III-23

2000 350/355 XL LAND YACHT

SECTION IV L through Z

[LABELS and TAGS](#) IV-1

[OPTIONS](#) IV-3

PLUMBING

[LPG](#) IV-5

[Utility compartment](#) IV-6

[Freshwater](#) IV-7

[Faucets](#) IV-10

[Drain water](#) IV-14

[Toilet](#) IV-19

[SAFETY EQUIPMENT](#) IV-20

SEALS/SEALER/PAINT

[Gaskets](#) IV-21

[Sealer](#) IV-23

[Adhesive](#) IV-24

[Paint](#) IV-24

[UPHOLSTERY/FOAM/MATTRESS](#) IV-25

[VENTS/FANS](#) IV-33

[WOOD/INTERIOR TRIM](#) IV-34

2000 350/355 XL LAND YACHT

SECTION I

A through C

APPLIANCES

Air conditioner.....	I-1
Furnace.....	I-1
Micro-wave	I-1
Range	I-2
Refrigerator	I-2
Water heater.....	I-3

BODY

CS wall.....	I-5
RS wall.....	I-7
Slide out extrusions	I-8
Slide out gaskets	I-9
Front end	I-11
Aft end.....	I-13
Roof	I-14

CHASSIS

Hitch.....	I-15
Power jacks	I-15
Step	I-15
Automotive air conditioner	I-16
Auxiliary heater	I-16

2000 350/355 XL LAND YACHT

APPLIANCES

DUO THERM AIR CONDITIONER-BRISKAIR

690323-06	Air conditioner, Briskair 11, 000 BTU
690323-07	Air conditioner, Briskair 13, 500 BTU
690323-22	Relay kit, analog control
690323-20	Thermostat, analog
690323-103	Shroud, exterior, Briskair
203069	Register, white, 4" x 8"
690323-12	Cover, return grill

FURNACE, HYDROFLAME (800-825-4328)-dealer only

690274	Furnace, Hydroflame, #8535-IV, 34000BTU
690244-06	Mounting flange
690274-06	Door exterior, Hydroflame
601244-03	Register, Rotaire, black
600969-01	Grille, 6x4, col. white
600247	4" duct hose, flexible

MICROWAVE

690368-01	Microwave/convection oven, Sharp
690345-03	Trim ring, microwave mounting

2000 350/355 XL LAND YACHT

APPLIANCES

RANGE

690396-02 Range top, 3-burner, Maytag
690396-02 Range cover, bi-fold
964383-01 Range covers, Corian, set

DOMETIC REFRIGERATOR, RM3862R (800-366-3842)

690370-01 Refrigerator, 2-way, RH, RM3862R
801225-01 Door panel, upper, Oak, 15.5x20.38"
801225-03 Door panel, lower, Oak, 38.38x20.38
690370-100 Cooling unit, RM3862
381207-03 Vent, roof, Dometic, polar white

2000 350/355 XL LAND YACHT

APPLIANCES

ATWOOD WATER HEATER, GC6AA-9E

- 690406 Water heater, Atwood, elec. ignition, 110 volt/gas
- 500933 Switch, water heater, electronic
- 690209 Access cover, brushed aluminum

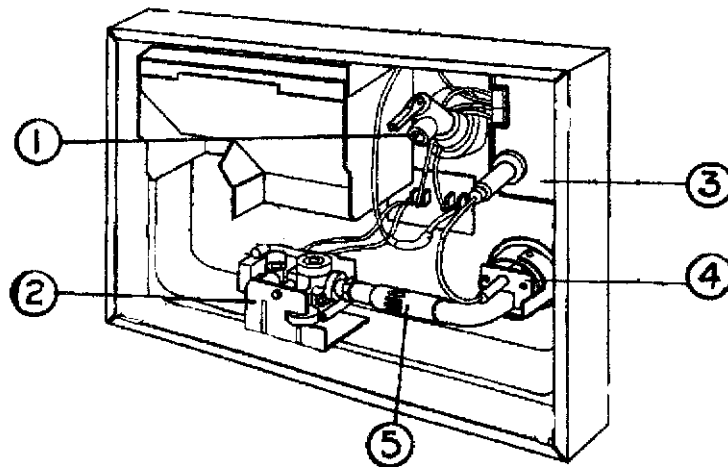

Front of water heater

- 1) 091604 Relief valve, pressure/temperature
- 2) 093870 Solenoid valve
- 3) 093865 Circuit board
- 4) 093868 Spark probe
- 5) 092615 Main burner

Back of water heater

- 091160 heating element, 110volt
- 091873 ECO thermostat
- 091092 On/off switch, 110Volt

2000 350/355 XL LAND YACHT

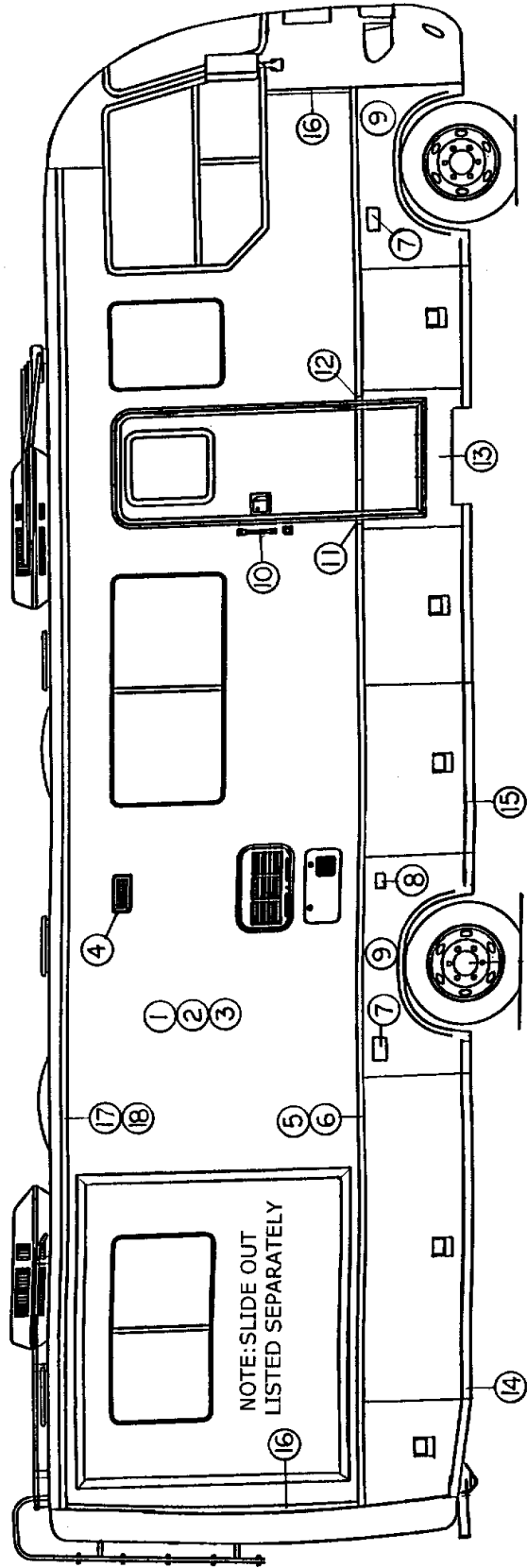

2000 350/355 XL LAND YACHT

CURBSIDE WALL

- | | |
|---------------|--|
| 1) 801002-08 | Sheet fiberglass, Frost White, 77.5" x 384" |
| 2) 801261 | Panel, interior, G1S, 1/8" x 4' x7' Antiquity Buff |
| 3) 203075 | Styrofoam sheet, 1 1/2" |
| 4) 510672-02 | Porch light, white |
| 5) 203080-01 | Molding, vinyl, white, rub rail |
| 6) 114865 | Extrusion, rub rail, 18' |
| 7) 511101-01 | Light, docking, stainless steel |
| 7a) 201991 | Housing, docking light |
| 8) 511250-02 | Light, side-marker, amber |
| 9) 203171 | Fender skirt, front and rear |
| 10) 381696 | Grab handle, embossed "AIRSTREAM" |
| 11) 114914-02 | Cap, end, rub rail extrusion, LH |
| 12) 114914-01 | Cap, end, rub rail extrusion, RH |
| 13) 203179 | Panel, skirt, main door |
| 14) 114717-07 | Weldment, rocker panel, CS |
| 15) 114708-01 | Extrusion, rocker panel |
| 16) 114862-01 | Extrusion trim end cap to sidewall |
| 17) 114568 | Extrusion, roof corner cap |
| 18) 114570 | Extrusion, awning rail |

2000 350/355 XL LAND YACHT

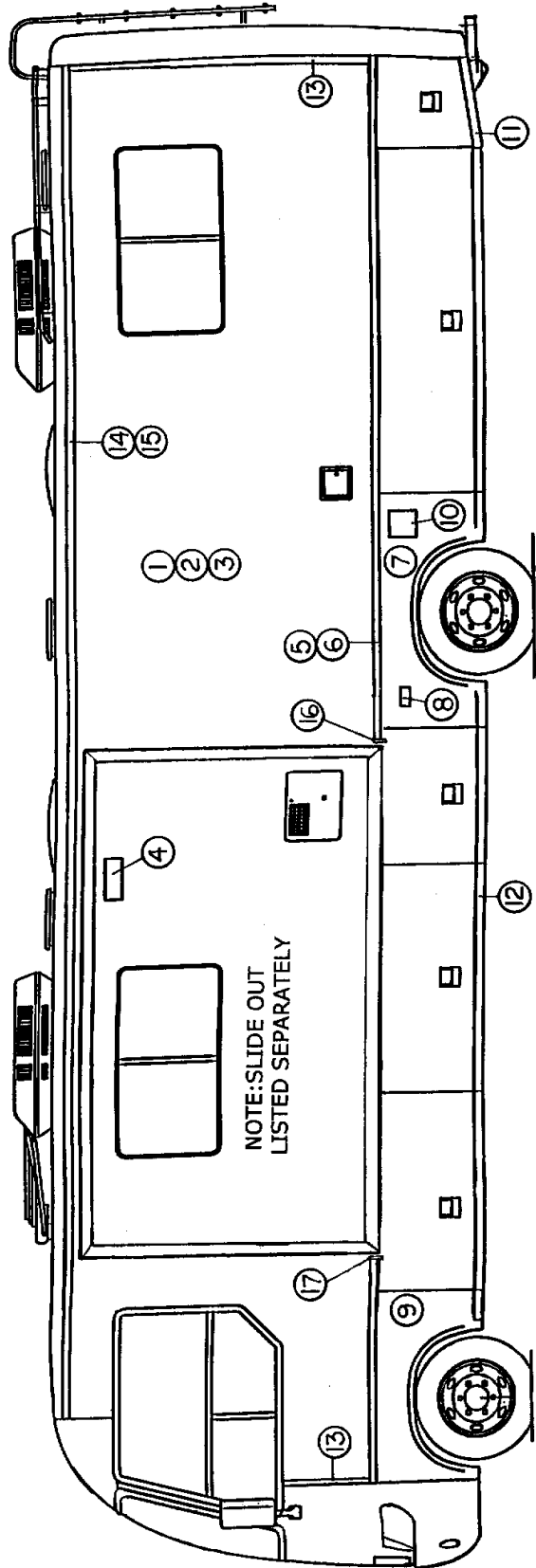

2000 350/355 XL LAND YACHT

ROADSIDE WALL

- | | |
|---------------|--|
| 1) 801002-08 | Sheet fiberglass, Frost White, 77.5" x 384" |
| 2) 801261 | Panel, interior, G1S, 1/8" x 4' x7' Antiquity Buff |
| 3) 203075 | Styrofoam sheet, 1 1/2" |
| 4) 511152-01 | Vent cover, range hood, white |
| 5) 203080-01 | Molding, vinyl, white, rub rail |
| 6) 114865 | Extrusion, rub rail, 18' |
| 7) 203172 | Fender skirt w/fuel fill |
| 8) 511250-02 | Light, side-marker, amber |
| 9) 203171 | Fender skirt, front and rear |
| 10) 203047 | Bezel, fuel fill |
| 11) 114717-08 | Weldment, rocker panel, RS |
| 12) 114708-01 | Extrusion, rocker panel |
| 13) 114862-01 | Extrusion trim end cap to sidewall |
| 14) 114568 | Extrusion, roof corner cap |
| 15) 114570 | Extrusion, awning rail |
| 16) 114917-01 | End cap, rub rail, RH, at slide out |
| 17) 114917-02 | End cap, rub rail, LH, at slide out |

2000 350/355 XL LAND YACHT

SLIDE OUT EXTRUSION

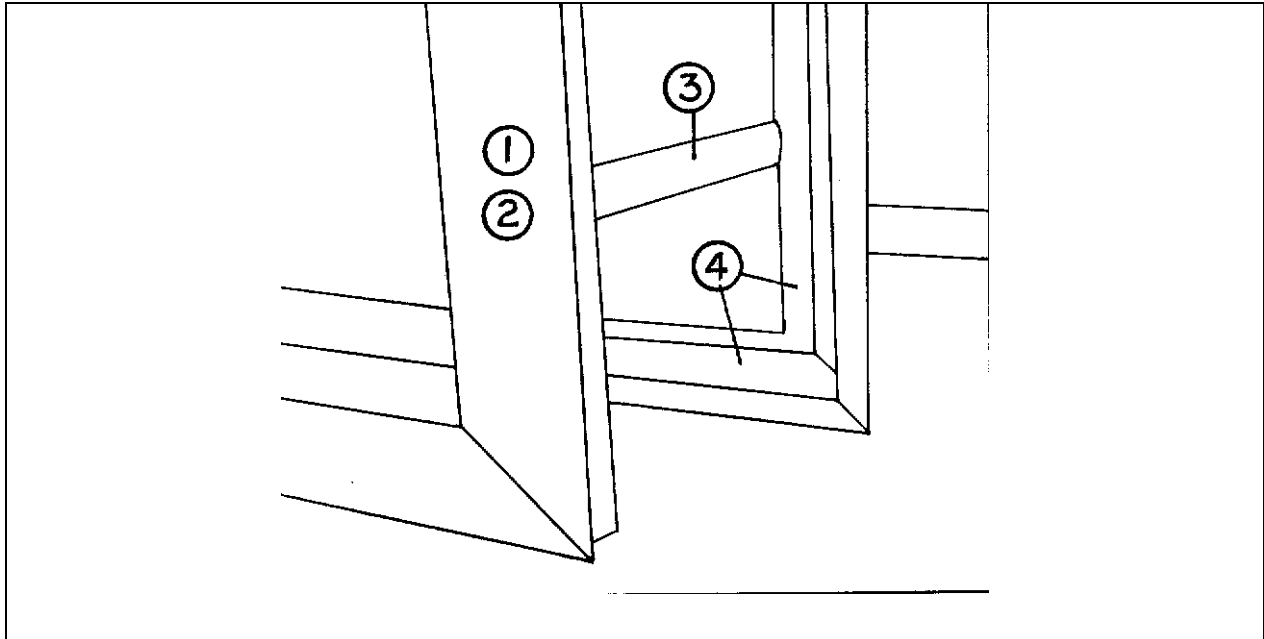

Lower rear corner, extended



*1) 114771 Extrusion, slide out

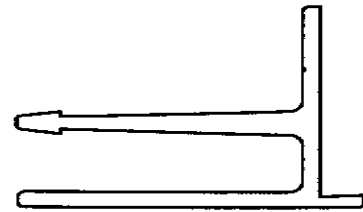

2) 114770 Extrusion, slide trim-out box (fits behind 1)

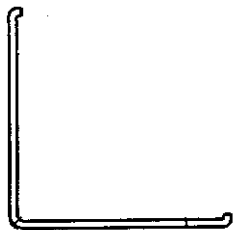

3) 114768 Extrusion, slide out corner trim

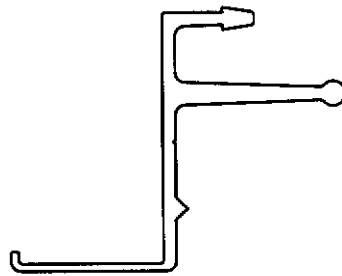

4) 114726 Extrusion, slide out frame

*This trim is slotted to allow adjustment to the sidewall Cutout. Fitting will be required.

2000 350/355 XL LAND YACHT

* SLIDE OUT GASKETS

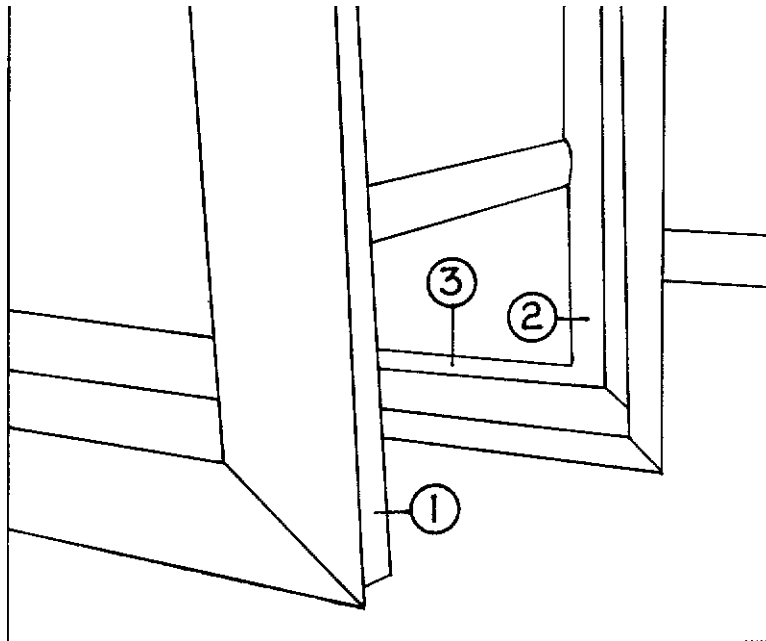

Lower rear corner, extended

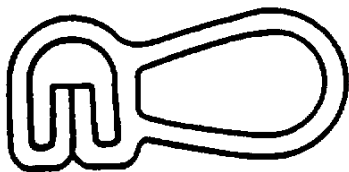

1) 381594 Rubber extrusion
bulb type, black

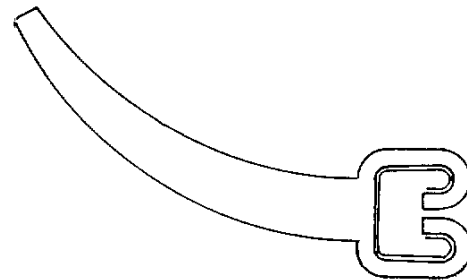

2 (381587 rubber extrusion,
wiper



3) 381589 Rubber extrusion
floor wiper



381588
Rubber extrusion, bulb
w/tape-used on inside wall

*Note: Mounting brackets can be found in hardware.

2000 350/355 XL LAND YACHT

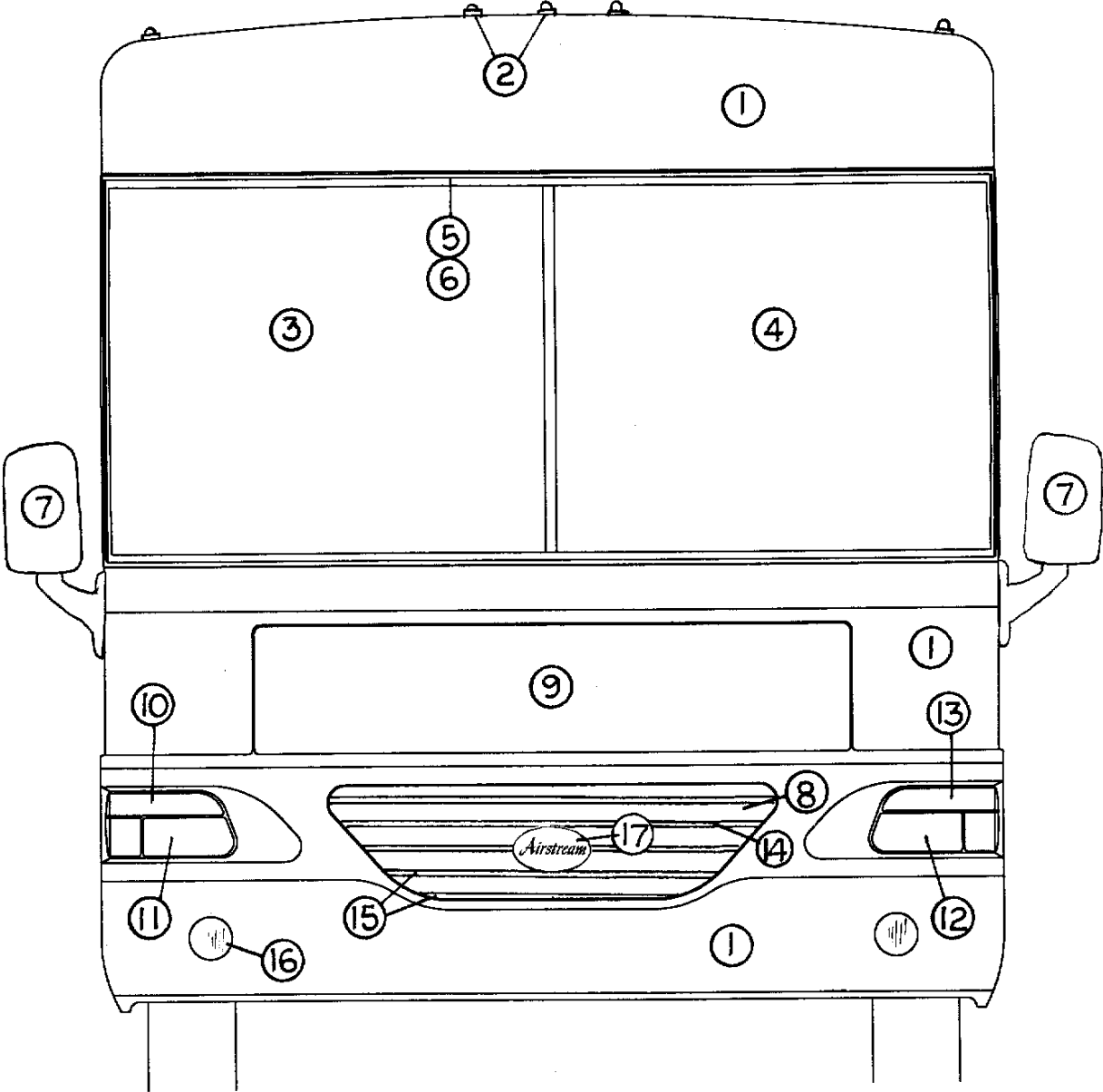

2000 350/355 XL LAND YACHT

FRONT END

- | | |
|---------------|--|
| 1) 203169 | Front nose/cap, XL |
| 2) 511400 | Light clearance, tear drop, amber |
| 3) 371370 | Windshield, CS |
| 4) 371369 | Windshield, RS |
| 5) 381640 | Gasket, windshields (surrounds both sides) |
| 6) 201260 | Insert rubber, windshield gaskets |
| 7) 511305-05 | Mirror, Velvac#2025 w/remote, heated, pr. |
| 8) 381642-01 | Grill, front |
| 9) 203173 | Hood, fiberglass, white |
| 10) 511398-02 | Parking light/turn signal RH |
| 11) 511397-02 | Head light, RH |
| 12) 511397-01 | Head light, LH |
| 13) 511398-01 | Parking light/turn signal, LH |
| 14) 453375 | Screen, nose, top, perforated steel |
| 15) 453376 | Screen, nose, middle and bottom |
| 16) 511514 | Driving light, round |
| 17) 386043-03 | Medallion "Airstream", black |

2000 350/355 XL LAND YACHT

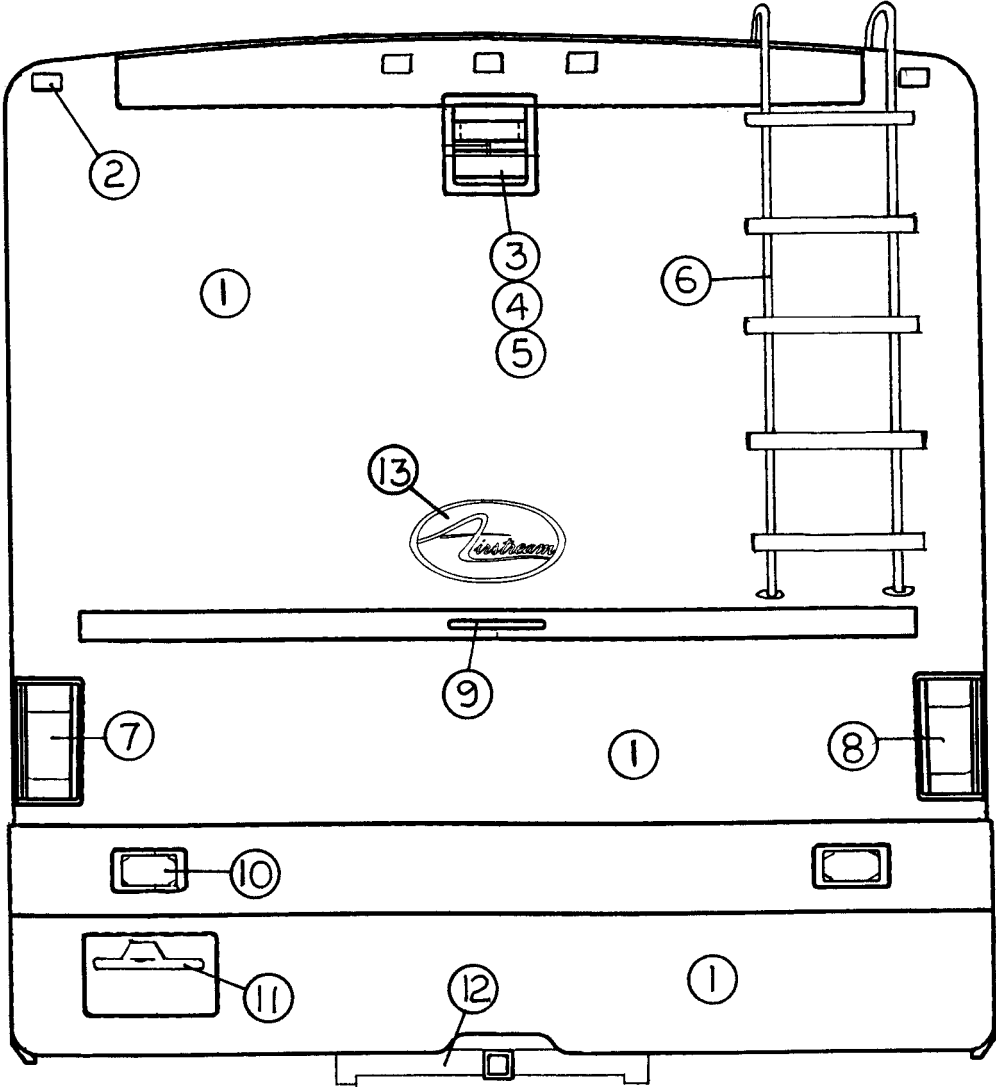

2000 350/355 XL LAND YACHT

AFT END

- | | |
|---------------|---|
| 1) 203170 | Rear cap, XL |
| 2) 510984-01 | Light clearance, red |
| 3) 510918-01 | Monitor, Sony Watchman |
| 4) 203181 | Cover, back up camera |
| 5) 511044-03 | Actuator, two position, push/pull |
| 6) 381639-01 | Ladder, rear cap, 2pc(bottom not shown) |
| 7) 511401-01 | Tail light assembly, LH |
| 8) 511401-02 | Tail light assembly, RH |
| 9) 511154-02 | Light strip, 3rd brake |
| 10) 511101-01 | Docking light, stainless steel |
| 11) 511407 | License plate light w/holder |
| 12) 400868 | Hitch, Reese #38502 |
| 13) 386043-03 | Medallion "Airstream", black |

Not shown:

- 345388 Screw, #8 x 1.5 stainless steel, truss head
(tail light mounting)

2000 350/355 XL LAND YACHT

ROOF

203024	Fiberglass sheet, roof exterior, 106"wide
114568	Extrusion, roof corner cap
114570	Extrusion, awning rail
702482	Ceiling liner, Spectra Opal
800507-01	Paneling, luan, ceiling liner backing
201728-01	Extrusion, ceiling trim retainer
201728-04	Extrusion, ceiling trim
203609	Registers, ceiling vents

2000 350/355 XL LAND YACHT

CHASSIS

410868-02	Reese hitch, XL Land Yacht
410825	Jack kit complete, Power Gear
453653	Bracket, L.P. tank, RH
453654	Bracket, L.P. tank, LH
410631	Winch assembly, spare tire
453295	Hanger, spare tire
511485	Step, double, electric
511486	Switch, magnetic, round, black, in doorjamb
511022-100	Motor, double step
511485-100	Control box, main, black
451811	Extender, tire valve, pr.
400924	Tire, Goodyear 245/70R 19.5 LRF
410828	Simulators, wheel, stainless steel, Ford
410828-01	8.5"Live stem valve extension, rear inner
203187-01	Mud flap w/logo RS
203187-02	Mud flap w/logo CS
410827	Pipe, fuel fill, 29"

2000 350/355 XL LAND YACHT

CHASSIS

Acme
(800-552-2263)

690382-01	Heater, air conditioner evaporator
690408-01	Kit heater/ac accessory, w/Tarus control
60000283	Vacuum hose, 3/16"
690382-05	Suction hose kit
390382-08	Hose kit heater/ac, 99Ford

AUXILIARY HEATER

690311	Heater, auxiliary
600247	Duct hose, 4"
600678	Adaptor grill, 10 x 2"
600969	Register 4 x 6", sand
0310072	"Y" auxiliary heater hose connection

2000 350/355 XL LAND YACHT

DASH

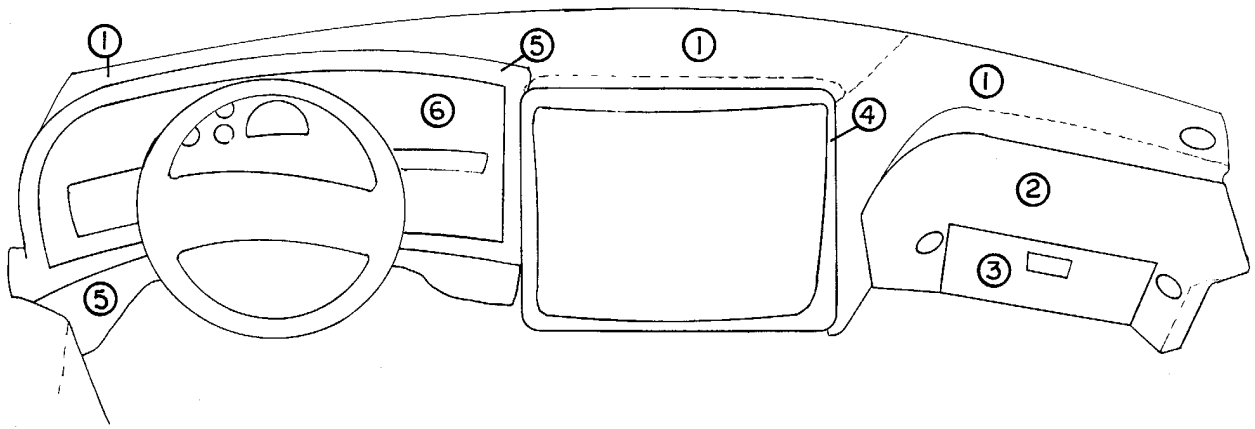

- | | |
|-----------|---|
| 1) 203176 | Dash, main, vinyl wrapped |
| 2) 203193 | Glove box module, wrapped |
| 3) 203189 | Door, glove box w/latch |
| 4) 203177 | Trim ring, TV, vinyl wrapped |
| 5) 203178 | Trim ring, instrument panel |
| 6) 203200 | Panel, dash cluster, burl |
| 203197 | Cover, top, steering column (not shown) |

2000 350/355 XL LAND YACHT

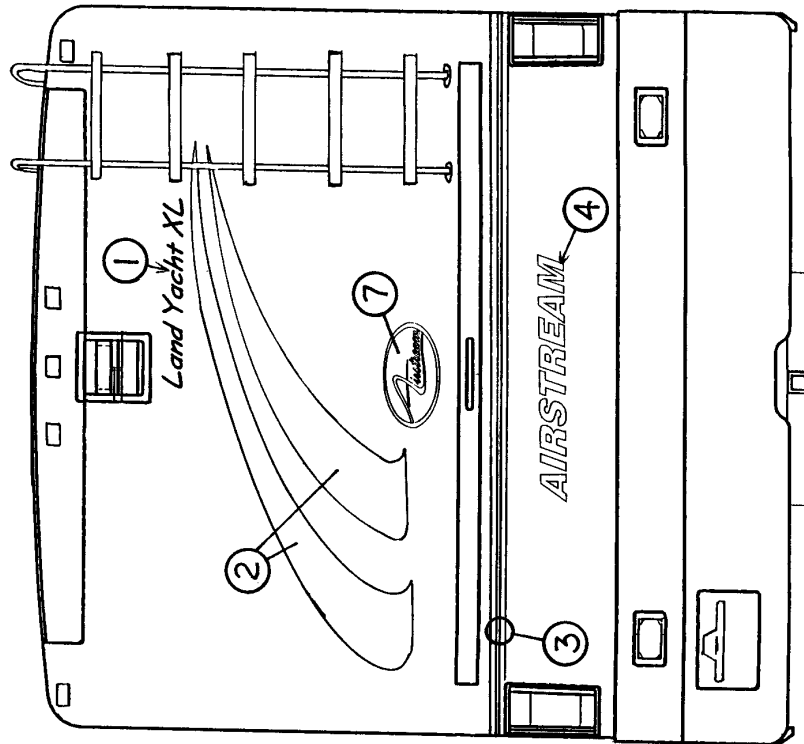
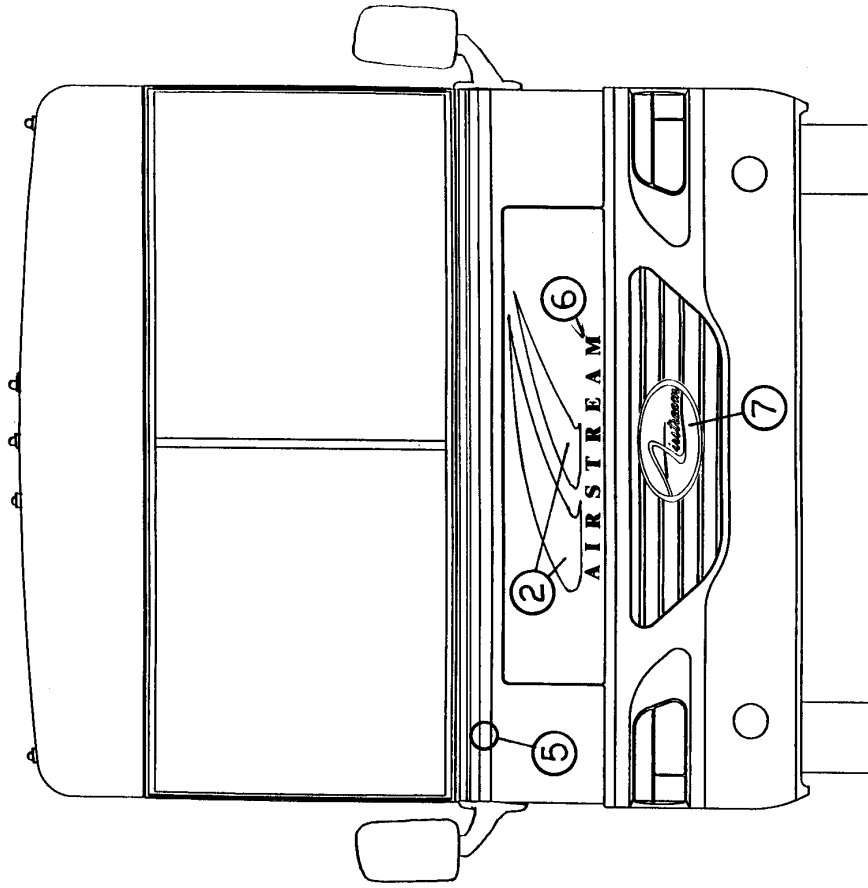

2000 350/355 XL LAND YACHT

DECALS FRONT AND REAR

Emerald Clay & Autumn Wood

- 1) 386026-01 Decal, logo, "Land Yacht XL"
- 2) 386023-01 Decal, front & rear graphic
- 3) 386031-01 Decal, stripe, rear, gold/blue
- 4) * NOT DECAL-part of paint scheme
- 5) 386028-01 Decal, stripe, front, blue/green
- 6) 386025-01 Decal, logo, "Airstream"
- 7) 386043-03 Medallion, "Airstream", black

Drift Wood & Blue Bayou

- 1) 386026-02 Decal, logo, "Land Yacht XL"
- 2) 386023-02 Decal, front & rear graphic
- 3) 386031-02 Decal, stripe, rear, two color
- 4) * NOT DECAL part of paint scheme
- 5) 386028-02 Decal, stripe, front, two color
- 6) 386025-01 Decal, logo, "Airstream"
- 7) 386043-03 Medallion, "Airstream", black

*Paint color codes are provided with each unit and are also kept on record in the Airstream sales department.

2000 350/355 XL LAND YACHT

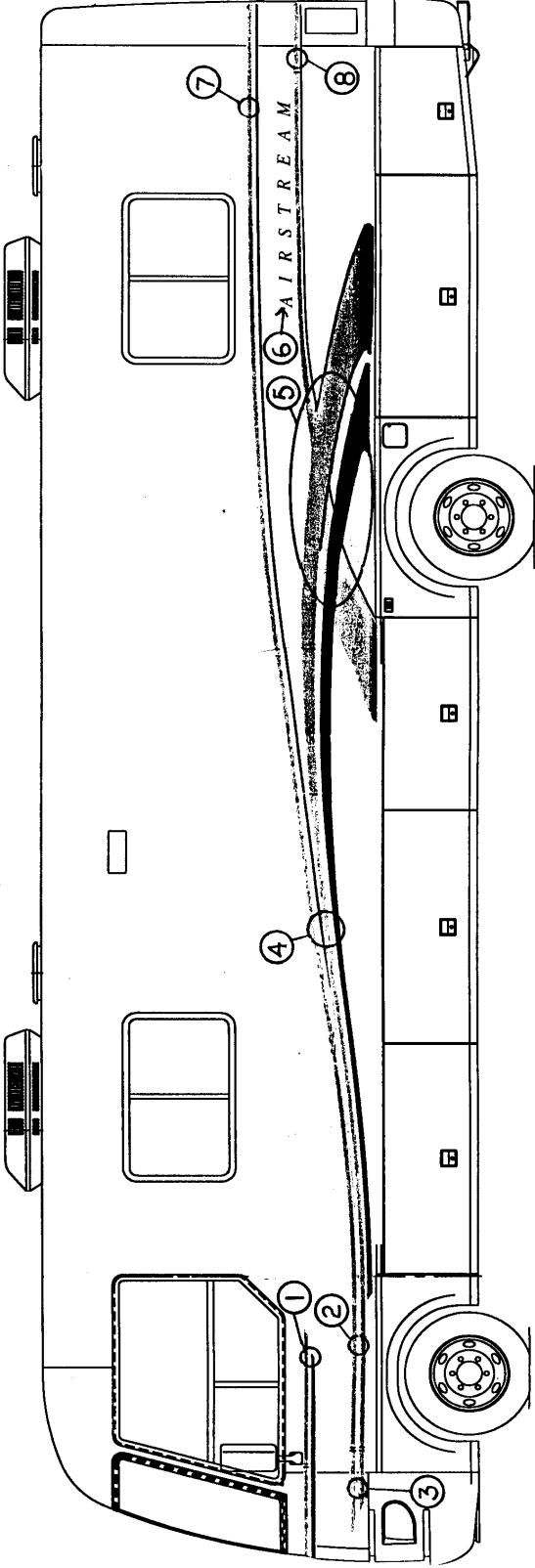

2000 350/355 XL LAND YACHT

DECALS

Emerald Clay & Autumn Wood

- | | |
|---------------|--------------------------------------|
| 1) 386028-01 | Decal, front stripe, blue/green |
| 2) 386030-01 | Decal, side stripe, gold/green |
| 3) 386027-01 | Decal, "355" |
| 3a) 386027-02 | Decal, "350" |
| 4) 386021-01 | Decal, forward graphic, RS |
| 4a) 386021-02 | Decal, forward graphic, CS |
| 5) 386020-01 | Decal, main graphic, RS |
| 5a) 386020-02 | Decal, main graphic, CS |
| 6) 386036-01 | Decal, logo, "AIRSTREAM" |
| 7) 386032-01 | Decal, stripe, side sweep, gold/blue |
| 8) 386031-01 | Decal, rear stripe, gold/blue |

Drift Wood & Blue Bayou

- | | |
|---------------|--------------------------------------|
| 1) 386028-02 | Decal, front stripe, two color |
| 2) 386030-02 | Decal, side stripe, two color |
| 3) 386027-03 | Decal, "355" |
| 3a) 386027-04 | Decal, "350" |
| 4) 386021-03 | Decal, forward stripe, RS |
| 4a) 386021-04 | Decal, forward stripe, CS |
| 5) 386020-03 | Decal, main graphic, RS |
| 5a) 386020-04 | Decal, main graphic, CS |
| 6) 386036-01 | Decal, logo, "AIRSTREAM" |
| 7) 386032-02 | Decal, stripe, side sweep, two color |
| 8) 386031-02 | Decal, rear stripe, two color |

DECAL, INTERIOR

- | | |
|--------|--|
| 386033 | Decal, logo. "Land Yacht XL" 7 1/2" Gold |
| 386034 | Decal, logo, "Airstream" 7 1/2" Gold |

Note: Paint information is provided with motorhome. A record of this is also kept in the Airstream Sales Dept.

2000 350/355 XL LAND YACHT

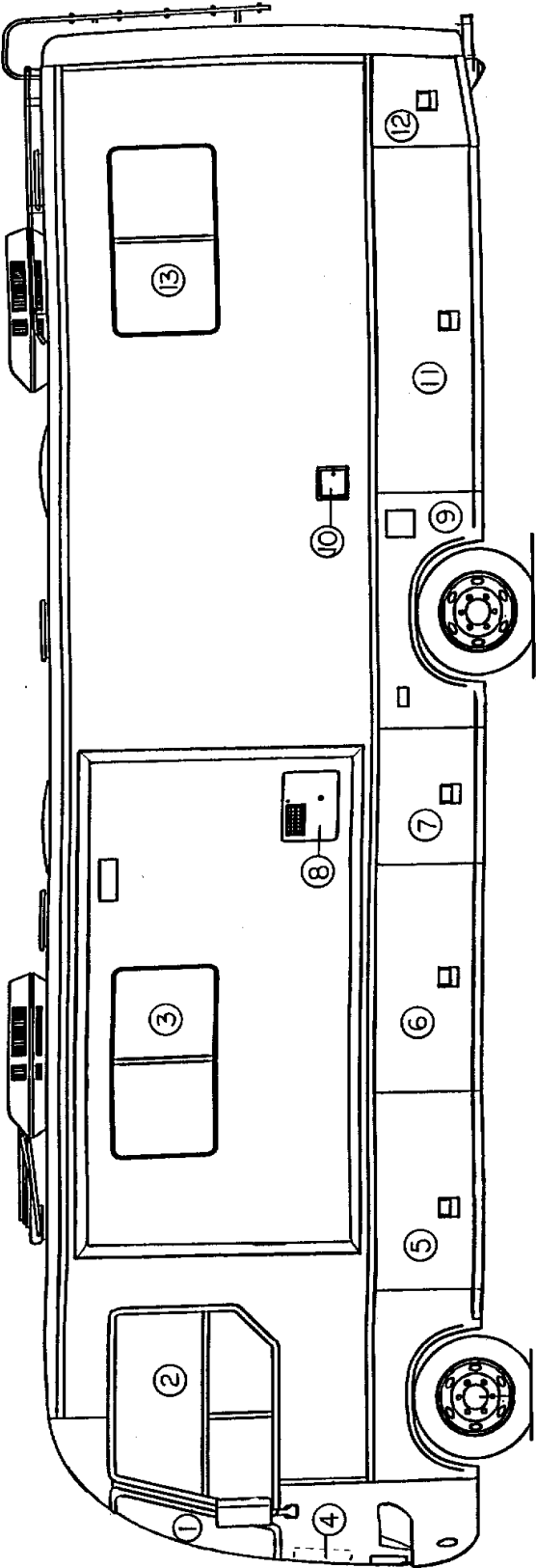

2000 350/355 XL LAND YACHT

DOORS/WINDOWS-RS

- | | |
|---------------|--|
| 1) 371369 | Windshield, RS |
| 2) 371365-01 | Cab window, RS |
| 3) 371366-25 | Window, RS horizontal slide, 22 x 43" |
| 4) 203173 | Hood, fiberglass, white |
| 5) 921189 | Compartment door, 61.38" |
| 6) 921189 | Compartment door, 61.38" |
| 7) 921188 | Compartment door, 51.50" |
| 8) 690259-05 | Access door, water heater |
| 8a) 690259-06 | Flange, mounting, water heater |
| 9) 381641 | Door, fuel fill |
| 10) 921178 | Water fill, potable water |
| 11) 921184 | Compartment door, 63.88" |
| 12) 921186 | Compartment door, 34.00" |
| 13) 371366-24 | Window, RS, horiz. Slide, egress, 26 x 43" |

NOT SHOWN:

- | | |
|-----------|----------------------------------|
| 702949-03 | Cover, galley slide out, Dometic |
| 702949-01 | Hardware, galley slide out cover |

2000 350/355 XL LAND YACHT

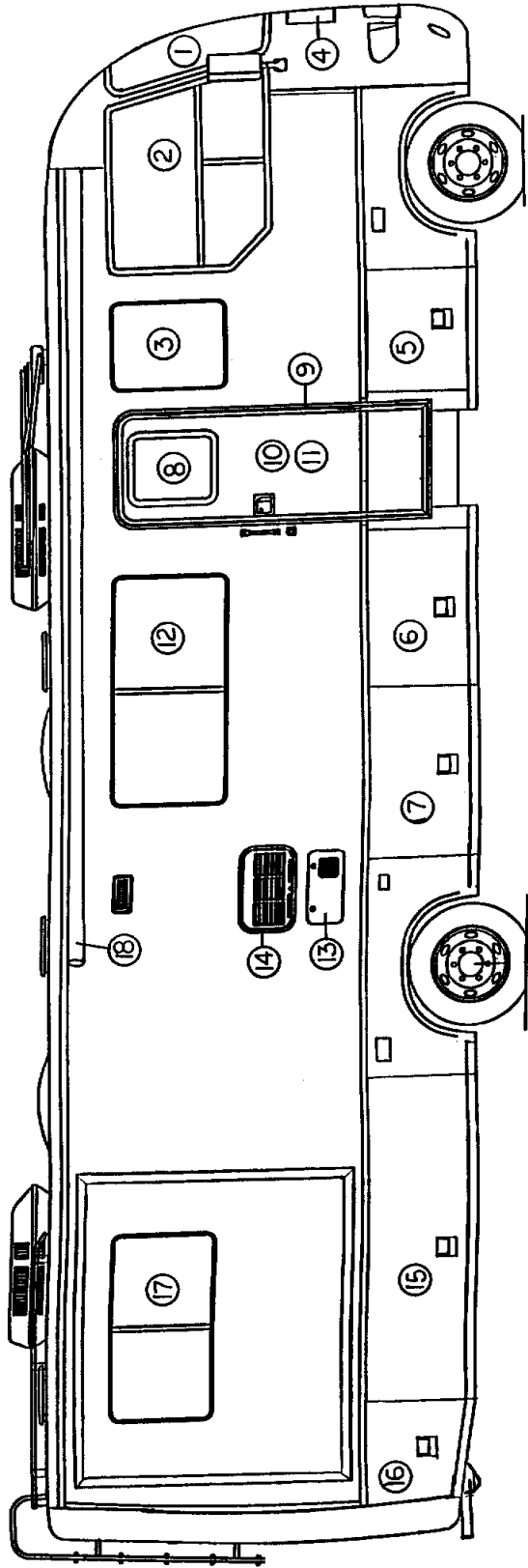

2000 350/355 XL LAND YACHT

DOORS/WINDOWS

CURBSIDE

- | | |
|----------------|--|
| 1) 371370 | Windshield, CS |
| 2) 371365-02 | Cab window, CS |
| 3) 371366-26 | Window, vertical slide, 26.0 x 21.50" |
| 4) 203173 | Hood, fiberglass, white |
| 5) 921185 | Compartment door, 31.0" |
| 6) 921183 | Compartment door, 51.5" |
| 7) 921183 | Compartment door, 51.5" |
| 8) 371366-01 | Window, stationary, 19.25 x 23.25 |
| 9) 922500 | Jamb, main door |
| *10) 110581 | Main door assembly |
| *11) 922503 | Screen door |
| 12) 371366-23 | Window, horizontal slide, 26 x 43" |
| 13) 690274-05 | Door, Hydroflame, exterior |
| 14) 690340-03 | Refrigerator door, flush mount |
| 15) 921184 | Compartment door, 63.88" |
| 16) 921187 | Compartment door, 34.0" |
| 17) 371366-23 | Window, horizontal slide, 26 x 43.0" |
| 18) 702679-34 | Awning, patio, 17', Sapphire Blue |
| 18a) 702679-11 | Hardware, patio awning, tall, satin finish |

NOT SHOWN:

702949-02 Cover, bedroom slide out, Dometic

702949-01 Hardware, bedroom slide out cover

* More detail can be found on following pages.

2000 350/355 XL LAND YACHT

MAIN and SCREEN DOOR

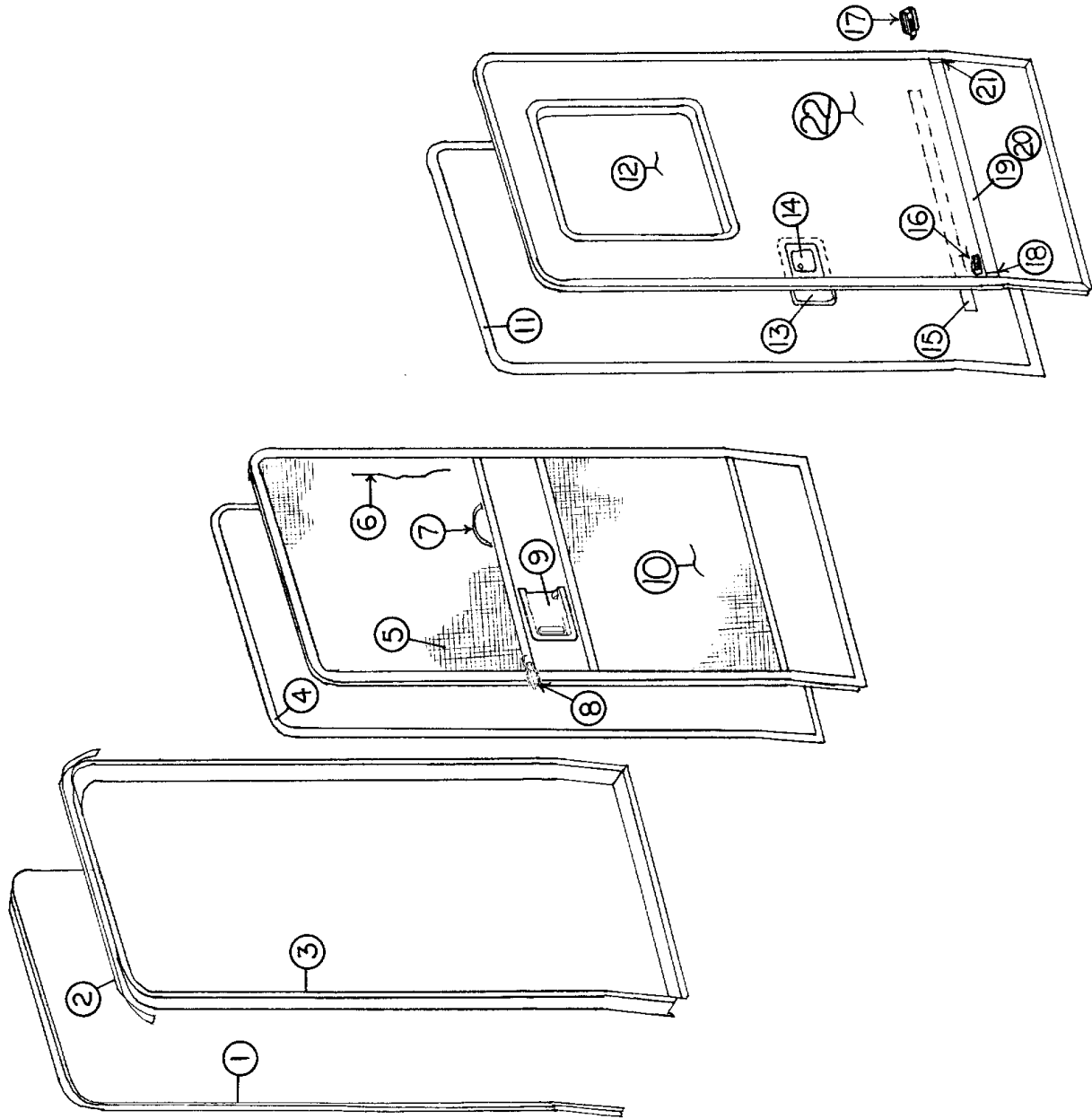

2000 350/355 XL LAND YACHT

MAIN and SCREEN DOOR

- 1) 114884 Trim, inside doorjamb
- 2) 114059 Drip cap, main door
- 3) 922500 Jamb, main door
- 4) 365013-01 Gasket, screen door, low-density foam
- 5) 380079 Screen, plastic mesh
- 6) 200518 Spline, gray, round, screen installation
- 7) 380004 Pull handle, screen door w/screws
- 8) 381454 Latch, screen door, double action, Bullet
- 9) 203000 Close out, plastic, sliding, screen door, (Gizzy)
- 10) 922503 Screen door assembly
- 11) 365045 Seal, main door
- 12) 371366-01 Window, double pane, stationary, 19.25 x 23.25
- 13) 203002 Cover, inner door lock pocket, plastic
- 14) Door lock The main door lock is made up of five separate parts- see hardware in Section III for listing
- 15) 114005 Trim, inside door face(also used as roof trim)
- 16) 201056 Catch, main door hold back
- 17a) 380291 Main door hold back, used w/housing 380290
- 17b) 380290 Latch housing, main door hold back
- 18) 114914-02 End cap, rub rail, LH
- 19) 114865 Extrusion, rub rail
- 20) 203080-01 Molding, 2", white vinyl, rub rail
- 21) 114914-01 End cap, rub rail, RH
- 22) 110581 Main door assembly

2000 350/355 XL LAND YACHT

DRAPES/BLINDS/VALANCES

964117-01	Valance, galley 29" w/26.25 leg	
964792-02	Valance, large, bedroom	
964786-01	Valance, small, CS lounge	
964792-01	Valance, large, living room	
964730-02	Shadow box assy., bedroom area	
964731-01	Shadow box assy., lounge CS,	
964732-01	Shadow box assy., lounge, RS	
964730-01	Shadow box assy., dinette/lounge area	
702969-29	Shade, pleated, night,	45.00" x 29"
702968-29	Shade, pleated, day/night,	45.00" x 29"
702968-30	Shade, pleated, day/night,	45.00" x 25"
702968-31	Shade, pleated, day/night,	23.50" x 29"
702968-26	Shade, pleated, day/night,	61.25" x 27", Ascot
702952	Blind, galley cover	
702951	Windshield wrap curtain w/track & strap	

2000 350/355 XL LAND YACHT

ELECTRICAL

110 VOLT

510634	Power cord, 36ft.
511426	Converter, electronic, 55 amp
511336	Breaker box, Square D, 30amp
510633	Breaker, 30 amp
510662	Breaker, double pole, 20/20
510661	Breaker, 20 amp, GFI
511444	Transfer switch, 2-30 amp
510606	Priority switch and box-front/rear air conditioner
500563	Receptacle, 15 amp, Ivory
511451-02	Receptacle, 20amp, single, brown
511451-01	Receptacle, 20 amp, single, white
510888-05	Outlet w/cover, white, GFI
500785	Outlet, duplex, brown
510676-01	Outlet, exterior, gray
511023	Tester, circuit analyzer (loose item)
511278	Lock out, 110 volt disconnect, front TV

2000 350/355 XL LAND YACHT

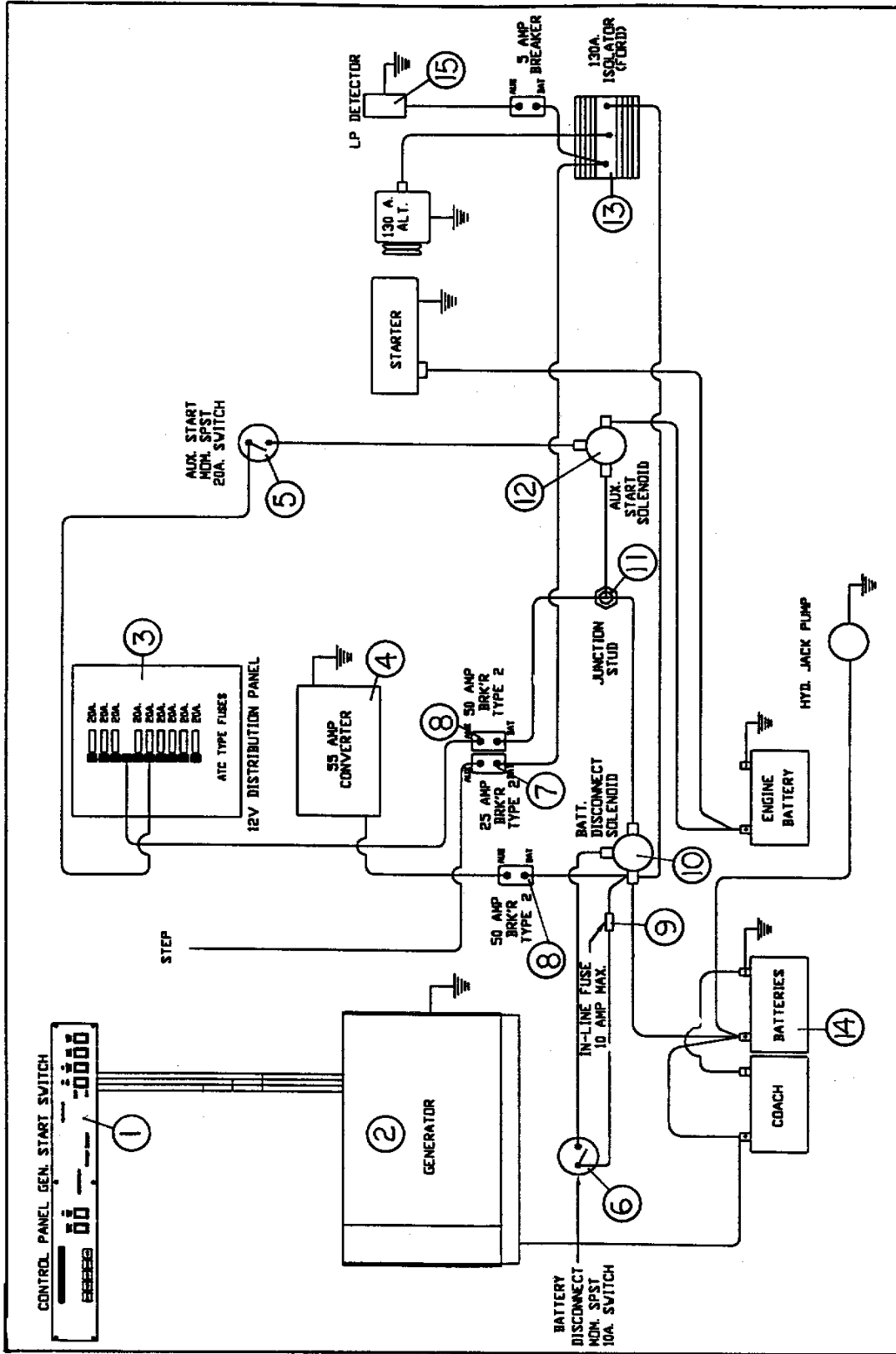

2000 350/355 XL LAND YACHT

*ELECTRICAL 12-volt-CHASSIS

- | | |
|---------------|---|
| 1) 511446 | Monitor panel |
| 2) 511038 | Generator, Onan Marquis, 6.5 LP |
| 3) 511016 | Fuse block, 12-volt, 9 position, ATC type |
| 4) 511426 | Converter, electronic, 55 amp |
| 5) 510929-02 | Switch, auxiliary start, momentary, SPST |
| 6) 962203 | Battery disconnect switch(part of four gang
switch cluster at main door) |
| 7) 510947-30 | Breaker, 12-volt DC, 30 amp, w/ears |
| 8) 510947-50 | Breaker, 12-volt DC, 50 amp |
| 9) 510696 | Fuse holder, in-line |
| 10) 511351 | Solenoid, latching, cont. duty, kill switch |
| 11) 511090 | Junction block, stud type |
| 12) 511199 | Solenoid, continuous duty, aux. start |
| 13) 510642-01 | Isolator, 130 amp |
| 14) 511132 | Battery, deep cycle |
| 15) 511309 | Detector, LPG |

*see ENTERTAINMENT section for radio, VCR, TV, antennas
etc.

2000 350/355 XL LAND YACHT

ELECTRICAL

12-volt-GENERAL

511132	Battery, deep cycle
511016	Fuse block, 12-volt, 9 position, ATC type
510947-20	Breaker, 12-volt, automatic, type II-20amp
510947-30	Breaker, 12-volt, automatic, type II-30amp
510947-50	Breaker, 12-volt, automatic, type II-50amp
510947-25	Breaker, 12-volt, automatic, type II-25amp
510947-05	Breaker, 12-volt, automatic, type II-5amp
500475-50	Breaker, 12-volt, 50amp w/mounting ears
500475-30	Breaker, 12-volt, 30amp w/mounting ears
500475-05	Breaker, 12-volt, 5amp, w/mounting ears
511392	Fuse holder, 15 amp, in-line
510328	AGC fuse , 10amp
500773-01	ATC fuse, 1amp(LP detector)
510596	Cigarette lighter
510807	Outlet, 12-volt, lighter receptacle
511276	Cover, 12-volt outlet, black

2000 350/355 XL LAND YACHT

12VOLT-DASH SWITCH & LENS

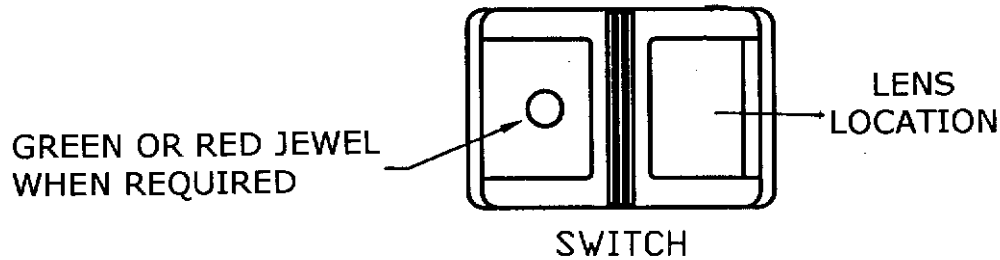

510929-04	Switch, rear heat
510929-06	Switch, TV speaker, SPST
510929-02	Switch, auxiliary start, ICC blink, momentary, SPST
510929-08	Switch, rear camera, momentary, DPDT
510929-05	Switch, driving light, aisle light, defrost fan, on-off, SPST
510929-07	Switch, docking light, inverter, on and off with red indicator light, SPST
511305-10	Switch, remote exterior mirror
510930-01	Lens, ICC blink
510930-02	Lens, door lock
510930-06	Lens, aisle light
510930-33	Lens, auxiliary start
510930-25	Lens, rear camera
510930-07	Lens, docking light
510930-31	Lens, TV speaker
510930-35	Lens, defrost fan
510930-29	Lens, map light
510930-04	Lens, rear heat

2000 350/355 XL LAND YACHT

12-volt-INTERIOR SWITCHES

511327	Switch body w/rocker, single
511328	Switch cover, printed white
511445	Switch, closet light, white
510868	Switch, 4 gang, bezel
500933	Switch , water heater
511040	Switch, door, momentary, normally on
962203	Switch cluster, main door
511513	Light, green, LED, monitors battery disconnect
511078	Switch body, illuminated
511083-02	Cover, switch, 3&4 gang
511445	Switch, closet light white
520316	Switch, remote, slide out

12-volt-INTERIOR LIGHTS

500960-02	Light, fluorescent, recessed, 20.63"
680085	Bulb, fluorescent, #F8T5-CW
500960-01	Light, fluorescent, recessed, 14.75"
680084	Bulb, fluorescent, #F8T5-CW
511298	Wall lamp, 12-volt, rectangular
511298-02	Shade, wall lamp, rectangular
510689	Bulb, incandescent, #1076
511467-01	Wall lamp, swing arm, brass
511467-02	Lampshade, round
510689	Bulb, incandescent, #1076

2000 350/355 XL LAND YACHT

ELECTRICAL

12-volt-INTERIOR LIGHTS

511248 Light, incandescent single, square
50085-02 Bulb incandescent, #1141

500842 Light, fluorescent, 12x5.5x1"
680084 Bulb, fluorescent, F8T5-CW

511422 Light, map, halogen, white
511137-100 Bulb, 12-volt, JC-10

511422-01 Light, map, halogen, black
511137-100 Bulb, 12-volt, JC-10

511410 Light, shower, incandescent
50085-02 Bulb, incandescent, #1141

511417 Wall light, Demi-sconce, slide out
510689 Bulb, incandescent, #1076

511454 Light, fluorescent, 15, watt
680085 Bulb, fluorescent, F15T8-CW

511387 Light, Acrylic Tiffany, galley

2000 350/355 XL LAND YACHT

ELECTRICAL

12-volt-EXTERIOR LIGHTS

511163	Light, compartment
510672-02	Porch light, white(high on side of unit)
510732	Utility light#1327 (by door)
511101-01	Light, docking, halogen, chrome bezel
201991	Housing, docking light
511401-01	Light, tail lamp, LH
511401-02	Light, tail lamp, RH
511154-02	Light strip, 3rd brake light, 1"x10"
510984-01	Light, clearance, red
511407	Light, license plate w/holder
511400	Light, front top marker, tear drop, amber
511397-02	Head light, RH
511397-01	Head light, LH
511402	Socket and pigtail, headlight
511406	Socket, front turn and parking light
511408	Socket, side marker w/194NA bulb
511250-02	Light, side marker, amber
511398-01	Park lamp, LH
511398-02	Park lamp, RH
511514	Driving light kit

2000 350/355 XL LAND YACHT

12-volt-MISC. EQUIPMENT

511305-05	Mirrors, exterior, Velvac w/remote, heated, pr
511305-10	Switch, remote, heated mirrors
511446	Monitor panel
511162-01	Keyless entry w/remote (opt)
511162-02	Transmitter, 4 channel
510802-01	Actuator, door lock, 5 wire
511141	Solar panel, 5 watt
511413	Light, solar panel
510781	Detector, smoke
511309	Detector, LPG
511343	Detector, carbon monoxide

2000 350/355 XL LAND YACHT

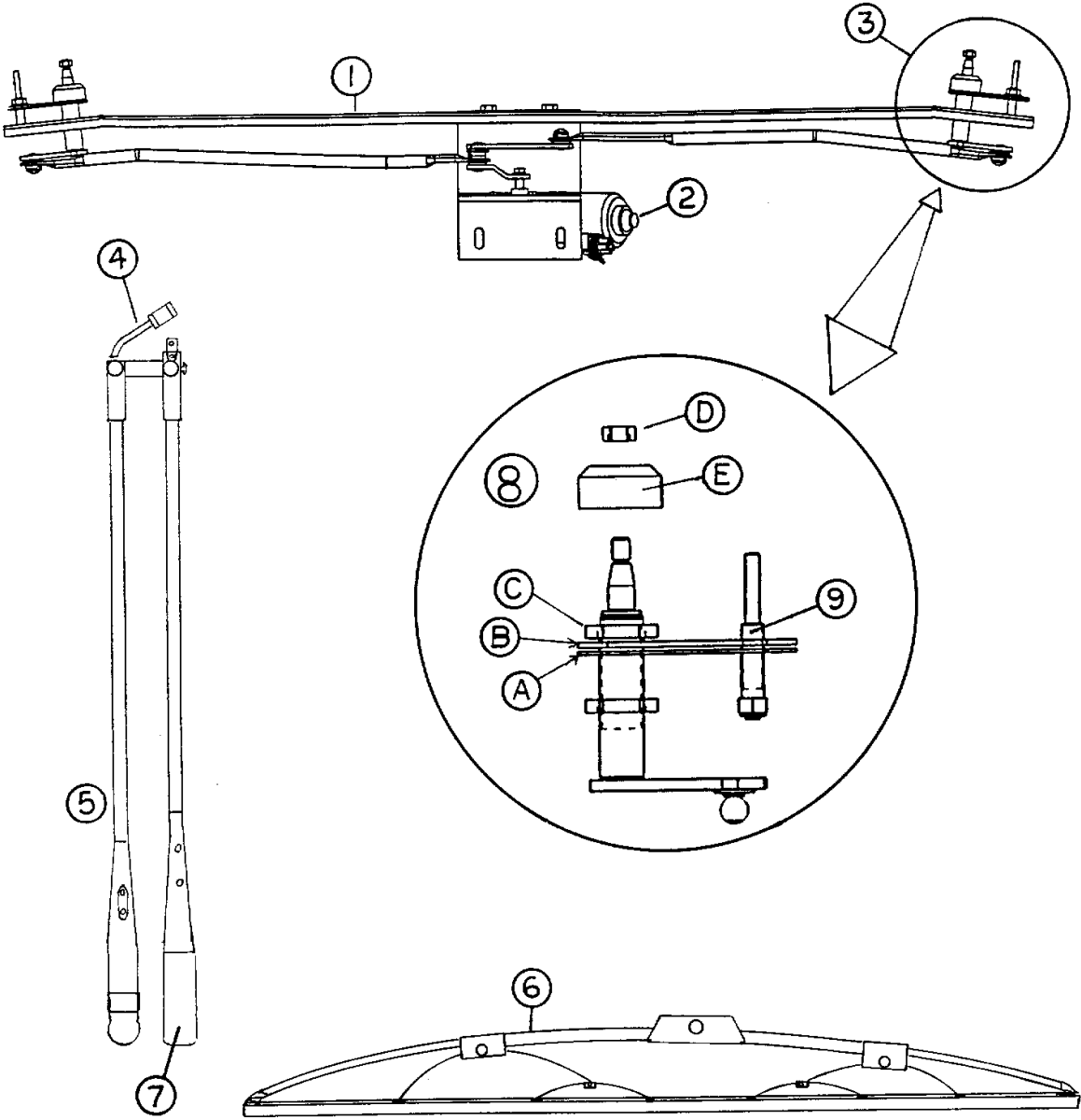

2000 350/355 XL LAND YACHT

ELECTRICAL

WINDSHIELD WIPER

- 1) 511440 Windshield wiper assy, XL
- 2) 511440-100 Wiper motor, Ford/Freightliner
- 3) 511440-102 Pivot and link assembly, Trico
- 4) 511419-103 Washer jet and tubing, Trico
- 5) 511419-104 Pantograph arm assembly, Trico
- 6) 511419-105 Blade assembly, 28", Trico
- 7) 511419-106 Head cover, main arm, black, Trico
- 8) 511440-107 Hardware kit, includes the following:
 - a) gasket
 - b) face plate
 - c) thin nut
 - d) 8 mm nut
 - e) rain shield
- 9) 511440-108 Swivel assembly, slave arm, Trico

2000 350/355 XL LAND YACHT

ENTERTAINMENT

510788-01	Antenna, TV, Winegard
510788-03	Amplifier, TV antenna
500976	Outlet, TV jack
500996	Jack, TV/phone, gray
511375-01	Jack, modular telephone, ivory
500994	Antenna, radio
511458	Antenna, side mount, CB
690419	TV, Sony, 20"
203177	Trim ring, TV , front
511373-01	Theatre sound system, 2-18 watt amplifiers (puts TV through front speakers)
511442	Radio w/CD player CDX-C4750
511048	Speaker, Coustic, #HS-402
511048-01	Speaker, Coustic, white
511385-02	Amplifier module, Theater sound system
511385-03	Cube speakers w/bracket, black
511385-04	Speaker, 6"x9", Theater sound
511385-05	Grill, for 6"x9" speaker
500974	Speaker/headphone system, opt.
500975	Headphones, lightweight, opt.
511423	Plug-earphone, opt.
511488-01	Mobile theater sound system, Sony, opt.
511383-02	Remote control, Sony, wireless, opt.
511191	CD changer, 10 disc, Sony CDX-715, opt.
511310	Video control center
114909-01	Bracket, TV mount, bedroom, RH
114909-02	Bracket, TV mount, bedroom, LH
381644	Swivel, TV
381664-02	Strap, safety, 1"black
381664-01	Thumb lock, safety strap, black

2000 350/355 XL LAND YACHT

ENTERTAINMENT

510918-01	Monitor, Sony Watchman
510929-08	Switch, momentary, rear camera
511044-03	Actuator, two position, rear camera
203181	Cover, back up monitor

2000 350/355 XL LAND YACHT

L through Z

LABELS and TAGS IV-1

OPTIONS IV-3

PLUMBING

LPG IV-5

Utility compartment IV-6

Freshwater IV-7

Faucets IV-10

Drain water..... IV-14

Toilet IV-19

SAFETY EQUIPMENT IV-20

SEALS/SEALER/PAINT

Gaskets..... IV-21

Sealer IV-23

Adhesive IV-24

Paint..... IV-24

UPHOLSTERY/FOAM/MATTRESS IV-25

VENTS/FANS IV-33

WOOD/INTERIOR TRIM..... IV-34

2000 350/355 XL LAND YACHT

*FASTENERS

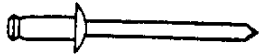

330126-02
rivet, pop, dia. 1/8"
grip range .126-.187
stainless steel body
stainless steel mandrel

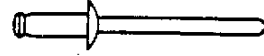

330126-03
rivet, pop, dia 1/8"
grip range .126-.250
stainless steel body
stainless steel mandrel

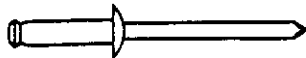

330136-04
rivet, pop, dia. 1/8"
grip range .313-.375
stainless steel body
stainless steel mandrel



330031-03
rivet, pop, dia 3/16"
grip range .125-.250
stainless steel body
stainless steel mandrel



330031-03
rivet, pop
dia.3/16"
grip range .126-.250
stainless steel body
steel mandrel



320108-01
rivet, bulb tite, w/washer
dia. 3/16"
grip range .050-.187
aluminum body
aluminum mandrel

*Common bolts and screws readily available at local hardware outlets have not been listed.

2000 350/355 XL LAND YACHT

*FASTENERS

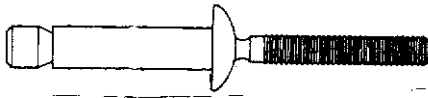

330139-02
dia. 1/4"
grip range .350-.625
stainless steel body
stainless steel mandrel

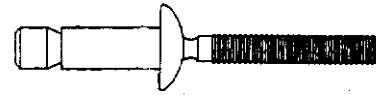

330139-01
dia. 1/4"
grip range .080-.375
stainless steel body
stainless steel mandrel

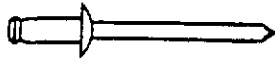

330127-03
dia. 1/8"
grip range .063-.125
aluminum body
aluminum mandrel



300101
1/8" I.D.
washer, aluminum

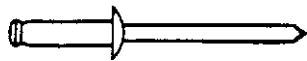

330127-05
dia. 1/8"
grip range .251-.312
aluminum body
aluminum mandrel

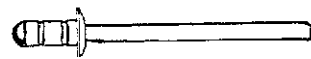

330137
dia. 1/8"
grip range .039-.189
aluminum body
steel mandrel

*Common bolts and screws available at local hardware outlets have not been listed.

2000 350/355 XL LAND YACHT

*FASTENERS



320122
screw, pan head, Phillips
black
#4 x 1/8" (glove box tray)



320114-04
screw wood oval head, Phillips
antique brass
#5 x 1/2"



320114-05
screw wood, oval head, Phillips
antique brass
#5 x 5/8"



320115-06
screw, wood, flat head,
Phillips stainless steel
#6 x 1.00"



320124-06
screw, flathead, Phillips
stainless w/white head

*Common bolts and screws readily available at local hardware outlets have not been listed.

2000 350/355 XL LAND YACHT

FLOOR COVERING

702793-07	*Carpet, Regal/Shadow, Roman Sands
700173-01	Carpet padding
701538	Carpet, Velour gray, storage compartments
201709-02	Extrusion, trim molding, black, baggage com.
702550	Matt, entrance, step well
702549	Matt, entrance, w/Airstream logo
702812-02	Step, tread, round, black
702893	Step tread, smooth rubber
702963	Vinyl, embossed, threshold, 1.75" wide
801115	Flooring, white Oak 3/8"
800639-02	Adhesive, Oak plank
360216	Acrylic latex caulk, brown
114724	Trim, carpet, Z bar

*See sample chart provided to your sales department for more carpet and upholstery part numbers.

2000 350/355 XL LAND YACHT

FURNITURE DOORS-INTERIOR

		(Inches)
800597-724	Door, raised panel	8.75 x 20.25
800597-574	Door, raised panel	9.00 x 16.25
800597-644	Door, raised panel	10.50 x 20.00
800597-014	Door, raised panel	10.50 x 22.00
800597-124	Door, raised panel	10.50 x 26.25
800597-594	Door, raised panel	11.50 x 18.50
800597-274	Door, raised panel	11.50 x 25.00
800597-064	Door, raised panel	12.25 x 16.00
800597-734	Door, raised panel	13.25 x 11.00
800597-444	Door, raised panel	13.75 x 29.75
800597-524	Door, raised panel	18.00 x 29.50

801157-12 Door, raised panel, smooth, 11.25" x 31.00"

MISCELLANEOUS DOORS

381643	Door, sliding, rear, 61" x 69.5"
801225-01	Door panel, refrigerator, upper, Oak
801225-03	Door panel, refrigerator, lower, Oak
964689	Bath door, hinged
964695	Door, aft bath slider 32" x 71"
964694	Door, forward bath slider 28.5" x 71"
702941	Shower door, gold, Aqua glass
800881-14	Door louvered, Oak, 33.5" x 12.00"
371374-01	Glass, tinted, 9.88" x 21.57", front roof locker
371375-01	Glass, tinted, 8.38" x 20.93", front roof locker

2000 350/355 XL LAND YACHT

FURNITURE MIRRORS

		(Inches)
372210-12	Mirror, beveled four sides	6.00 x 22.00
372210-13	Mirror, beveled four sides	6.00 x 41.50
372211-04	Mirror beveled three sides	11.00 x 16.75
372211-02	Mirror, beveled three sides	14.00 x 16.75
372211-01	Mirror, beveled three sides	15.25 x 16.75
372203-10	Mirror, safety glass	11.00 x 29.00
372203-19	Mirror, safety glass	11.13 x 22.50
372203-08	Mirror, safety glass	11.13 x 28.13
372203-13	Mirror, safety glass	16.25 x 29.00
372262-67	Mirror, safety glass	20.00 x 27.50
372262-66	Mirror, safety glass	31.00 x 66.88

DRAWER FACES

800599-584	Drawer face	4.75 x 21.50
800599-644	Drawer face	5.75 x 23.63
800599-384	Drawer face	7.00 x 21.50
800599-634	Drawer face (pantry)	7.75 x 60.75
800599-654	Drawer face	8.00 x 10.50
800599-664	Drawer face	8.00 x 14.25
800599-234	Drawer face	8.00 x 21.50
800599-294	Drawer face	11.75 x 21.50
800599-674	Drawer face	12.00 x 14.25

DRAWER BOXES

964906-02	Drawer box	2.75 x 19.50 x 18.00
964910-17	Drawer box	5.00 x 11.75 x 22.00
964910-06	Drawer box	5.00 x 19.50 x 14.00
964907-02	Drawer box	6.00 x 8.50 x 18.00
964907-04	Drawer box	6.00 x 12.25 x 18.00
964907-03	Drawer box	6.00 x 19.50 x 18.00
964909-01	Drawer box	8.50 x 18.00 x 10.00
964909-02	Drawer box	10.00 x 19.50 x 18.00
964909-03	Drawer box	10.00 x 12.25 x 18.00
964008	Lounge drawer box	

2000 350/355 XL LAND YACHT

FURNITURE

REAR BEDROOM W/SLIDE OUT

964712	Night stand assembly, LH
964664	Face frame, LH nightstand
964710	Top, LH night-stand
964713	Night stand assembly, RH
964664	Face frame, RH nightstand
964711	Top, RH nightstand
964798	Bed assembly
964719	Top, bed assembly
964759	Headboard, 60.25"
381067-07	Spring, gas prop, 90#
381262	Bracket, prop w/ball, angle
381263	Bracket, prop w/ball, straight
381085	Clip, retaining, gas prop
964750-01	TV cabinet assembly
964749-01	Face frame, rear TV cabinet
964692	Top, rear TV cabinet
964683	Breaker box cabinet(upper rear corner)
964641-01	Face frame, breaker box cabinet
964681	Wardrobe assembly, rear
964649	Face frame, rear wardrobe
381643	Sliding door, rear wardrobe

(continued)

2000 350/355 XL LAND YACHT

FURNITURE

REAR BEDROOM W/SLIDE OUT

964680	Bed assembly "S"
964719	Top, bed assembly "S"
964725	Corner cabinet assembly
964723	Face frame, corner cabinet, overhead
964749-01	Face frame, TV cabinet, bedroom
964749-02	Face frame, TV cabinet, bedroom
964755	Face frame, bedroom credenza, RH
964758	Face frame, bedroom credenza, LH
964756	Credenza assembly, bedroom
964757	Top, bedroom assembly
964682	TV cabinet assembly, bedroom, "S"
964750-02	TV cabinet assembly, bedroom, "B"

2000 350/355 XL LAND YACHT

FURNITURE

REAR BEDROOM-NON-SLIDE 350-"B"

964681-01	Wardrobe assembly, rear
964649-01	Face frame, rear wardrobe assembly
964798	Bed assembly
964797	Top, rear bed
964759	Headboard, 60.25"
964804	Nightstand assembly, LH
964809	Face frame, nightstand assembly, LH
964810	Top, LH nightstand assembly
964805	Nightstand assembly, RH
964812	Face frame, RH nightstand
964811	Top, RH nightstand
964724	Corner cabinet, bedroom
964722	Face frame, corner bedroom cabinet
964725-01	Corner cabinet, overhead, bedroom
964723-01	Face frame, overhead corner cabinet
964816	Roof locker assembly, bedroom
964817	Face frame, bedroom roof locker
964750-02	TV cabinet assembly, bedroom
964749-02	Face frame, bedroom TV cabinet
381227-01	Latch, vise action, curved pawl
114909-01	Bracket, TV mount, RH
114909-02	Bracket, TV mount, LH

2000 350/355 XL LAND YACHT

FURNITURE BATH AREA

964667	Roof locker, lavatory
964659	Face frame, lavatory roof locker
964660	Lavy cabinet assembly
964647	Face frame, lavy cabinet
964674-01	Lavy top
964666	Linen cabinet
964650	Face frame, linen cabinet
964956	Medicine cabinet
964955-004	Face frame, medicine cabinet
964689	Bath door, hinged
964652	Jamb, angled, bath door
961410-01	Jamb, bath door
964686	Header, bath door
961836	Magazine rack
381660	Dome plug, 3", black-clean out access
203180-01	Shower stall--reference only - repair in place

*Bath fixtures may be found in hardware--if connected to drains or water look in plumbing.

2000 350/355 XL LAND YACHT

GALLEY AREA W/SLIDE OUT

964971	Galley assembly, cook top section
964957-004	Face frame, galley cook top section
964970	Galley assembly, drawer module
964960-004	Face frame, galley drawer module
964669-01	Galley assembly, sink section
964960-004	Face frame, galley sink section
964673-02	Top, galley, Corian
964383-01	Range covers
601633-06	Sink, porcelain 18 x 32
964411-01	Sink cover, RH
964410-01	Sink cover, LH
964700-01	Corner closeout, Corian
964679-01	Wall cabinet, above galley
964663	Face frame, galley wall cabinet
964678	Roof locker, galley, over sink
964662	Face frame, galley roof locker
964677-01	Roof locker, galley, RH
964661	Face frame, RH galley roof locker
961836	Magazine rack, galley side
963990	Magazine rack, dinette side
963991	Spice rack
702952	Closeout blind (conceals back of galley slide out when in closed position)

(continued)

2000 350/355 XL LAND YACHT

FURNITURE

GALLEY AREA W/SLIDE OUT

964668	Refrigerator cabinet assembly
964642	Face frame, refrigerator cabinet
381551-01	Pantry rack
381551-02	Wire basket, 4" white
964704-01	Dinette seat sub assembly, RH
964537	Back, upholstered RH dinette seat
964703-01	Dinette seat sub assembly, LH
964706	Dinette back sub assembly, LH
964707	Upholstered back, LH dinette seat
964698	Table top, dinette, angle cut, Resistovar
962117-03	Leg, dinette table, hardwood, 30.5"
964675	Dinette roof locker
964638	Face frame, dinette roof locker

2000 350/355 XL LAND YACHT

FURNITURE CAB AND LOUNGE W/SLIDE OUT

964897	Roof locker, front(above windshield)
964893	Face frame, front roof locker
964895-02	Cab side panel, RS
964894	Face frame, RS cab panel
964895-01	Cab side panel, CS
964894-02	Face frame, CS cab panel
702897-03	Driver seat, power, w/ padded skirt
702898-02	Passenger seat, non-power, w/ padded skirt
*703022-399	Swivel chair, Roman Sands
452277-01	Pedestal, swivel chair
452277-02	Plate, pedestal
*702800-399	Sofa, jackknife, 68", Roman Sands
963507-02	Close out, upper cab, RS
963507-01	Close out, upper cab, CS
381515-05	Visor, front windshield
203112-01	Cover, A-post, RS
203112-02	Cover, A-post, CS
203040	Cover, center windshield post

*Changing the :-(dash) number to:

318 = Blue Bayou
258 = South Beach
248 = Vintage Leaf
379 = Mosaic Blue
389 = Tropical Isle

2000 350/355 XL LAND YACHT

FURNITURE

CAB and LOUNGE W/SLIDE OUT

964546-01	Arm rest assembly, RS
964547-01	Arm rest assembly, CS
200892	Cup holder, chrome plastic
964744	Header cabinet, main door
963809-01	Face frame, door header cabinet
800457	Dowel rod, Oak, 1/2"
800577-13	Trim, decorative, 25.25"
964676	Roof locker, lounge, CS
964639	Face frame, CS lounge roof locker
964743	Roof locker, lounge, RS, over sofa
964423	Face frame, RS lounge roof locker
964451-01	End cap, roof locker, LH
964451-02	End cap, roof locker, RH

2000 350/355 XL LAND YACHT

HARDWARE EXTERIOR-MAIN/SCREEN DOOR

TRIMARK main door lock

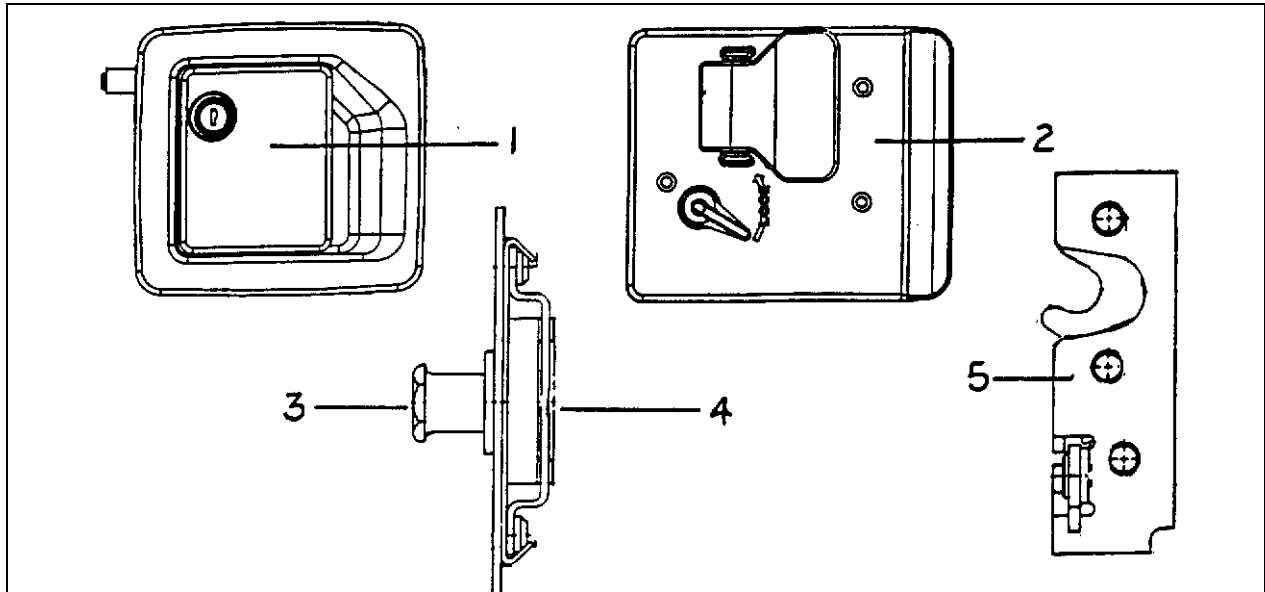

- 1) 381521-01 Outside lock housing
- 2) 381521-02 Inside lock plate
- 3) 381284 Sticker bolt
- 4) 381521-04 Caged nut
- 5) 381521-03 Rotary latch
- 381521-05 Screws, inside lock plate

Dead bolt-Tri-mark

- 510802-01 Actuator, door lock, 5-wire
- 381323-01 Dead bolt assembly
- 452030 Bolt, Tri-mark dead bolt
- 381326 Striker, 10007 w/Tri-mark dead bolt
- 345321-12 Screw, #8-32, flat head, black
- 200772 Pan, plastic, dead bolt, interior

2000 350/355 XL LAND YACHT

HARDWARE EXTERIOR-MAIN/SCREEN DOOR

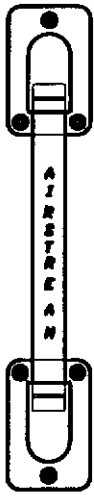

381696
Grab handle, embossed
"AIRSTREAM"

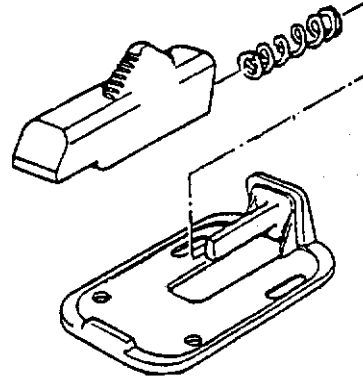

380291 Main door
hold back
(used w/housing #380290)

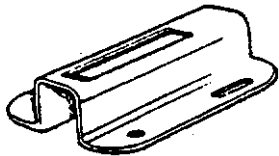

380290 Latch housing
main door holdback

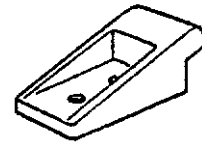

201056 Catch, main door
holdback

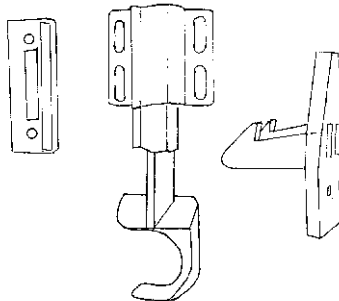

381454 Latch, screen door, Bullet

2000 350/355 XL LAND YACHT

HARDWARE EXTERIOR MAIN/SCREEN DOOR

381334	Hinge leaf, jamb, main door
381336	Hinge leaf, door, main
381377	Hinge leaf, screen door
385599-075	Bearing, sleeve, main door hinge
300118-01	Washer, nylon, main door hinge
310024	Hinge pin, .250 x 6.0"
203002	Cover, inner door lock
380004	Handle, with screw, screen door
203000	Close-out, screen door, plastic slide
380079	Screen, gray
200518	Spline, gray, screen door

WINDOW, SE-GI CO.

371366-100	Weep hole cover, SE-GI window
371366-101	Sweep latch, SE-GI window

HOOD

381638-01	Hood release kit
381638	Hinge, hood

2000 350/355 XL LAND YACHT

HARDWARE

EXTERIOR-LOWER COMPARTMENT

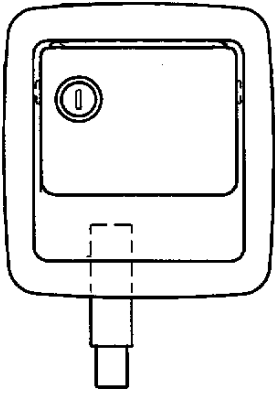

381637-01

Latch, lower comp.
Locking

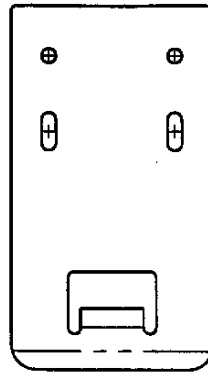

453707

Strike plate, comp.
latch

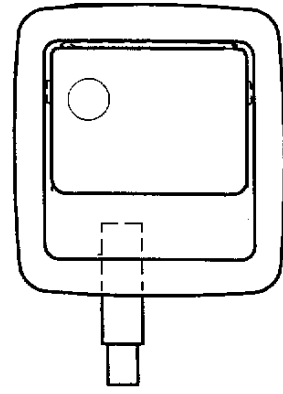

381637-02

Latch, lower comp.
non-locking



381569-02 Prop, gas spring, 60#

381569-04 Prop, gas spring, 20#

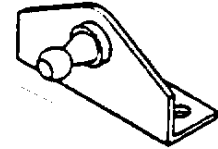

381262

Prop bracket w/ball,
angle, door mount

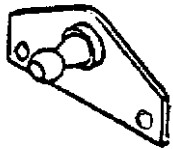

381263 Prop bracket w/ball
straight, jamb mount

LPG door only;

381659-01 Prop, 16" mech.

381659-02 Bracket, 16" prop

381659-03 Clip, 16" prop

(continued)

2000 350/355 XL LAND YACHT

HARDWARE

EXTERIOR-LOWER COMPARTMENT

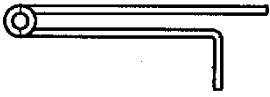

381650
Hinge, lower comp.
(Used on short doors
below slide outs)

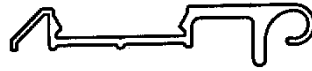

114864
Hinge, lower comp.
body side

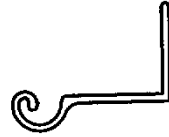

114863
Hinge, lower comp
door side

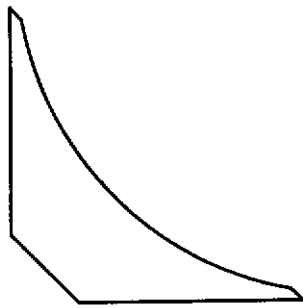

203184 Corner trim
lower compartment,
black plastic

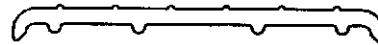

114869
Extrusion, threshold,
lower compartment

2000 350/355 XL LAND YACHT

HARDWARE SLIDE OUT ROOM Bedroom

381646	*Slide out system, Power Gear, bedroom
801216	Runner, bedroom roller
114885	Bracket, slide roller
381623	Roller, floor slide out
381592-02	Bar, travel lock, 20.0" bedroom
702949-02	Cover, bedroom slide out, Dometic
702949-01	Hardware slide out cover

GALLEY

410826	*Slide out system, Power Gear, galley
381623	Roller, floor slide out
381592-01	Bar, travel lock, 10.25", adjustable, galley
702949-03	Cover, galley slide out, Dometic
702949-01	Hardware, slide out cover

*For reference, only-Airstream does not stock Power Gear parts.

Power Gear 800-334-4712

2000 350/355 XL LAND YACHT

HARDWARE GALLEY SLIDE MECHANISM

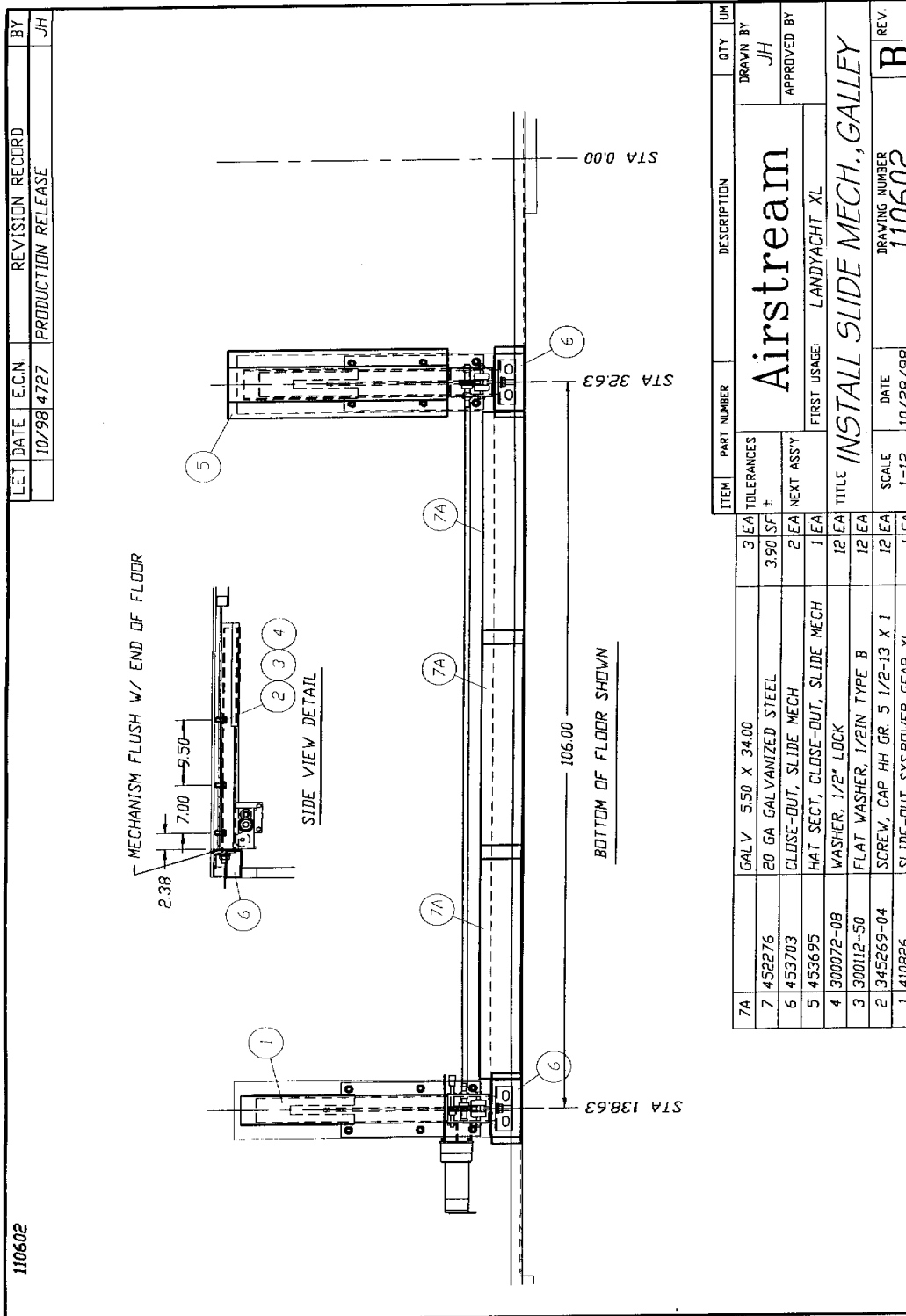

2000 350/355 XL LAND YACHT

HARDWARE-AWNING

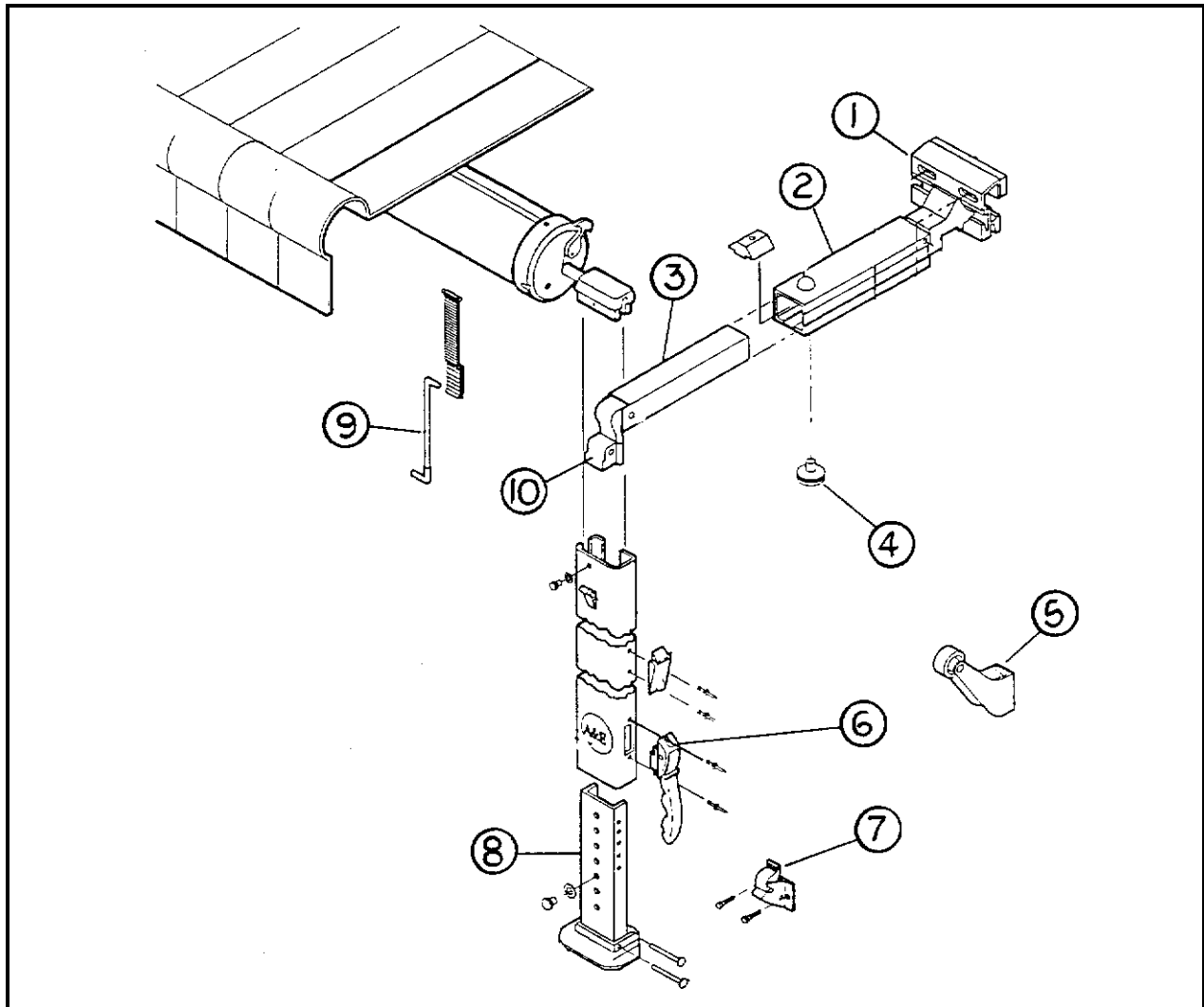

- | | |
|----------------|--------------------------------------|
| 1) 702679-104 | Bracket top, A&E awning |
| 2) 702679-103 | Rafter, main, A&E awning |
| 3) 702679-105 | Secondary rafter, A&E awning |
| 4) 702679-106 | Knob, adjustment, 1 7/8" A&E awning |
| 5) 702679-109 | Door roller, A&E awning |
| 6) 702679-111 | Lift handle, A&E awning |
| 7) 702679-108 | Bracket, bottom mounting, A&E awning |
| 8) 702679-107 | Arm, adjustable, A&E awning |
| 9) 702679-102 | E-Z pull rod, A&E awning |
| 10) 702679-110 | Slider assembly, A&E awning |

2000 350/355 XL LAND YACHT

HARDWARE

INTERIOR LATCHES/HINGES

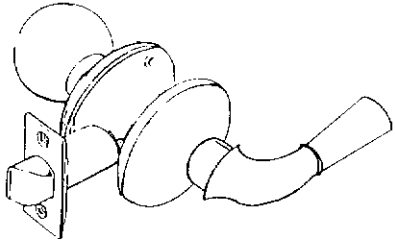

381022 Latch, swinging
bath door

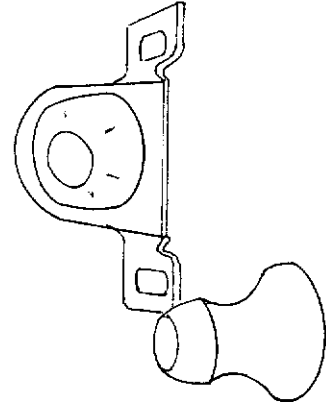

381074 Bulldog
door catch

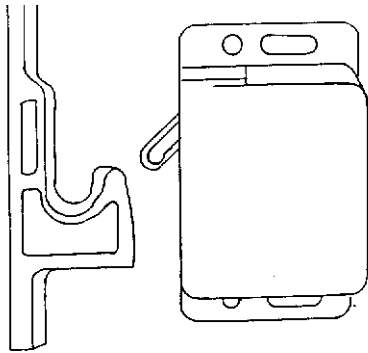

381228 Grabber door
latch w/catch, 10lb.rating
381228-01 Grabber door
latch w/catch, 3lb. rating

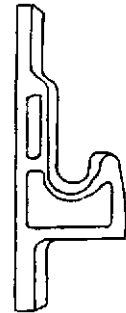

381228-100
Catch only, grabber
door latch

2000 350/355 XL LAND YACHT

HARDWARE INTERIOR LATCHES/HINGES

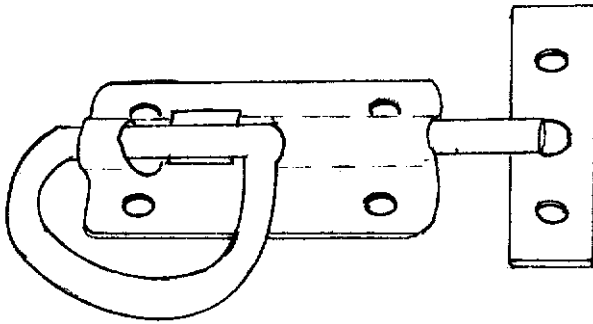

381109 Slide bolt latch

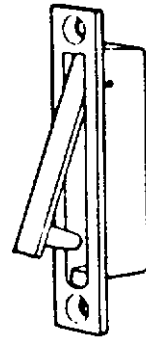

381444 Hatch pull

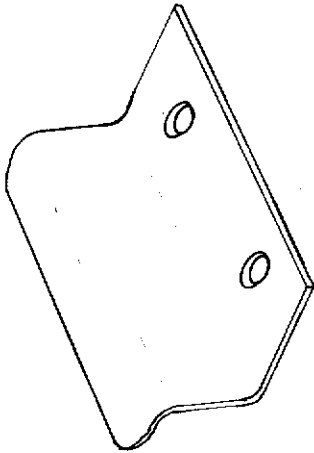

385940 Mirror pull, brass

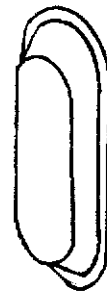

381603 Pull, three
three finger, brass



381599 Pull handle, drawer/door
Antique Brass

2000 350/355 XL LAND YACHT

HARDWARE INTERIOR LATCHES/HINGES

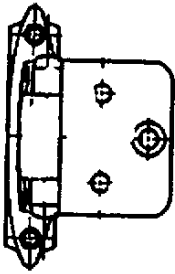

381601 Hinge, Antique
Brass

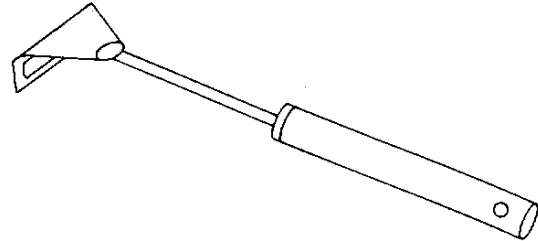

381147 Door support
spring loaded

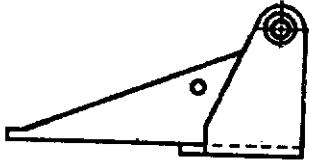

385935 Hinge, pivot, brass
for bath mirror

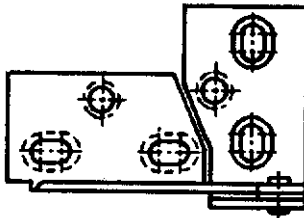

360012-01 Bumper
rubber, brown
cylindrical

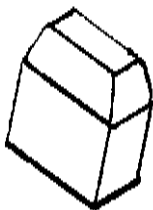

360016 Bumper, rubber
Gray, square, 3/8" x 3/8"

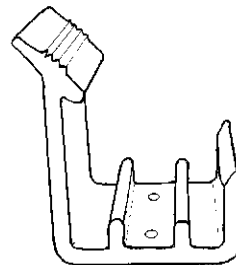

381643-01
Travel latch, rear wardrobe
sliding doors

2000 350/355 XL LAND YACHT

HARDWARE INTERIOR

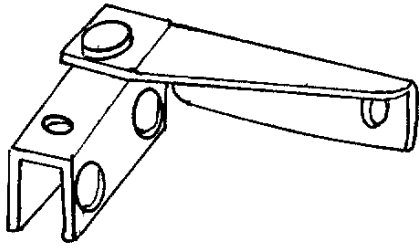

381654
Hinge, non bore
glass door, black



381655
Strike, glass door,
black

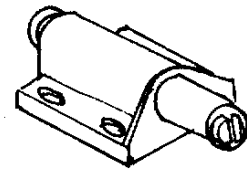

381653
Latch, single
touch, black

381526-01
381526-06

Drawer slide, 950RV, 14"
Rear bracket, adjustable, drawer slide

381443-01

Sliding door set, includes carriers, top plate
and track

200009

Sliding door guide

381658

Drawer guides, round-used at pocket door

381626-02

Towel bar, chrome and brass

380248

Soap holder, chrome

380034

Toilet paper holder, chrome

380017

Holder, toothbrush and tumbler

*381385

Dual lock #400

*381386

Dual lock #170

380045

Clothes rod

200975-04

Conduit, flexible, black plastic(covers rod)

380046

Clothes rod mounting bracket

381298

"J" bracket, center clothes rod support

*These two parts work similar to Velcro but have interlocking knobs rather than hooks and loops.

2000 350/355 XL LAND YACHT

SECTION IV L through Z

LABELS and TAGS IV-1

OPTIONS IV-3

PLUMBING

LPG IV-5

Utility compartment IV-6

Freshwater IV-7

Faucets IV-10

Drain water..... IV-14

Toilet IV-19

SAFETY EQUIPMENT IV-20

SEALS/SEALER/PAINT

Gaskets..... IV-21

Sealer IV-23

Adhesive IV-24

Paint..... IV-24

UPHOLSTERY/FOAM/MATTRESS IV-25

VENTS/FANS IV-33

WOOD/INTERIOR TRIM..... IV-34

2000 350/355 XL LAND YACHT

LABELS AND TAGS

385103	Plate, RVIA
385531	FMVSS certification label
385815	Name plate, motorhome hitch rating
385095	Tag registry#11999
385465	Label, exit warning (English)
385463	Label, warning label/cooking appliance
385464	Label, LP gas warning label (odor)
385788	Warning label, pilot light/refuel
385101	Tag, auxiliary tank dump valve handle
385099	Tag, black tank dump valve handle
385063	Label, drain cap
385062	Decal, 110-125 voltage AC
385309	Decal, fuel fill
385547	LP gas warning/fill label
385141	Tag, seat, clear w/black letters
385518	Label, dimension and clearance
385193	Label, 12Volt distribution inside
385560	Air conditioner rating label
385561	Generator rating label
385565	Label, holding tank flushing
385805-01	A/C priority switch label-front
385805-02	A/C priority switch label-rear
385812	Label, Calif. hazardous substance
385609	Label, smoke detector
385612	Label, parking brake warning
385620	Label, unleaded fuel only
385829	Decal, fuse and relay
385828	Decal, fuse panel warning
385851	Label, cellular phone

(continued)

2000 350/355 XL LAND YACHT

LABELS AND TAGS

385933	Label, name set relay
385941	Label, waste water holding
385942	Label, sewage holding tank
385943	Label, "cap must be in place"
385947	Label, 10-amp fuse maximum
385098	Label, seat occupancy
386012	Label, warning, water heater
385608	Label, sewer hose
385829	Decal, fuse and relay
385828	Decal, fuse panel
385931	Decal sheet, utility compartment
385989	Decal, mirror heat
385946	Label, warning, slide out operation
386014	Decal set, batt/aux start solenoid
386015	Decal set, 12v.circuit breaker
386016	Decal set, converter breaker

2000 350/355 XL LAND YACHT

OPTIONS

690413	VCR, Sony
511439	Inverter 400w, operates front TV from 12volt
203153-01	Skylight, 22" x 22" clear
203152-03	Skylight trim out 22" x 22" x 4"
702804-02	Shade, pleated, 20.25" x 21.00"
381564	Vent w/wall thermostat, Fantastic #2000TRS
690396-01	Range, 3-burner w/oven, Maytag
690425-03	Refrigerator, 10CF, 2-way, RH, NDR1062 w/ice
801225-014	Refrigerator door insert, 15.5" x 20.38"
801225-034	Refrigerator door insert, 38.38 x 120.38
511005	Generator, Onan, Marquis, 7000
702679-49	Awning, window, 4', Teal Tweed
702679-51	Awning, window, 4', Taupe
702679-50	Awning, window, 4', Saffire Blue
702679-12	Hardware, awning, window
963421-01	Table assembly, free standing, Oak NOMAR
963421-02	Table assembly, free standing, Oak laminate
703009-03	Chair, dinette, folding, Oak
801247	Table, stationary, Oak NOMAR
964948-01	Shelf, lift-up, galley

2000 350/355 XL LAND YACHT

OPTIONS

511162-01	Keyless entry w/remote
511162-02	Transmitter, 4 channel
511352	Module, locking, centralized
511149-04	Power cord, 50 amp 36'
510562-03	Switch-transfer, automatic, 50 amp
511149-02	Power inlet w/strain relief, 50 amp
702897-04	Passenger cab seat, power
703022-01	Swivel chair, leather
702966-01	Recliner, leather, Flex-steel
702818	Shade-Kool screen, black, cab area
690386	Toilet, Thetford China
511376	Fan, defrost, oscillating

2000 350/355 XL LAND YACHT

PLUMBING

LPG

601500	LP tank, 105# w/sender
511229	Sending unit, 90 ohm, Snap-on
601674	Regulator, LP gas, 2 stage
201135	Access cover, LP regulator
601673-02	LP hose, low pressure, 3/8" x 48"
601673-01	LP hose, low pressure, 3/8" x 48"
601279	LP hose, low pressure, 18in.
601412-08	Connector, 1/2" pipe to 3/8" flare
601412-12	Connector, 1/2" pipe to 5/8" flare
600003	Tee, 5/8" x 3/8" x 3/8" brass, flare
600004	Tubing, copper, 5/8 in.
600008	Tubing, copper, 3/8 in.
600436	Flare nuts, forged, 5/8 in.
600435	Flare nuts, forged, 3/8 in.

2000 350/355 XL LAND YACHT

PLUMBING FRESH WATER-UTILITY COMPARTMENT

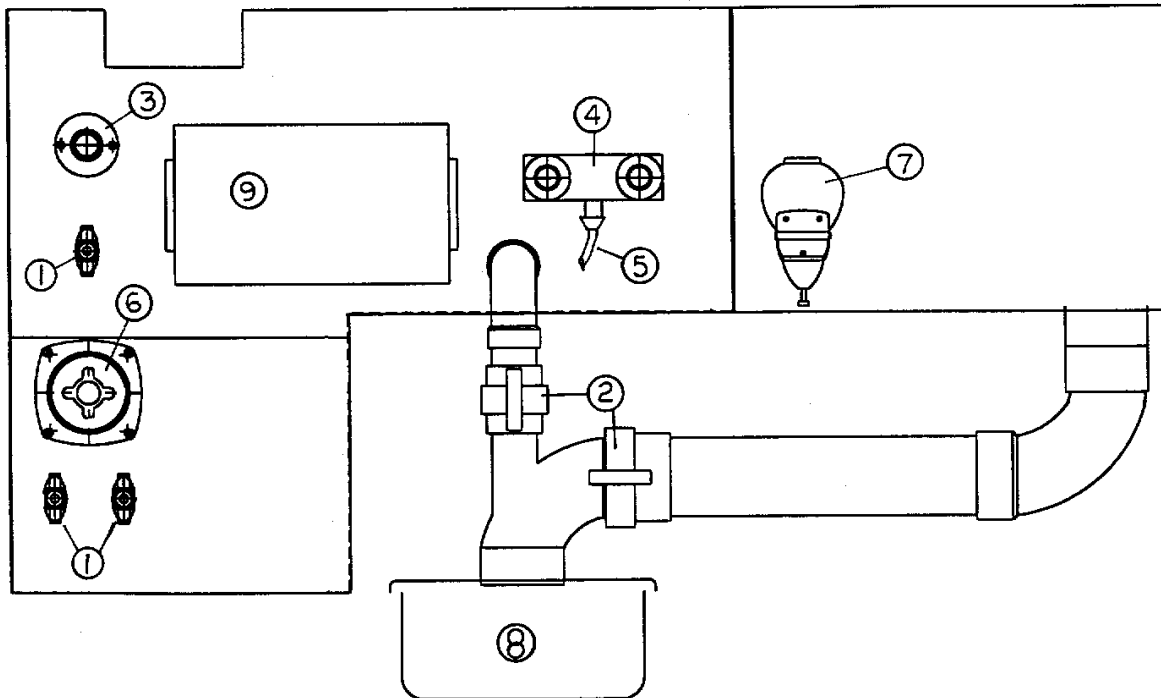

- 1) 601698-07 Shut-off, 1/2 barb x1/2 barb
- *2) Dump valve rods
- *3) 601197-01 Water hook up, black tank flush
- 4) 601592-03 Shower valve
- 5) 601592-02 Shower hose, white, 59in.
- 6) 601392 City water hook-up w/regulator
- 7) 381651 Dispenser, liquid soap
- 8) 203201 Pan, sewer hose storage
- 9) 203035 Holder, paper towel

*See drainage for more detail

2000 350/355 XL LAND YACHT

PLUMBING FRESH WATER

601724-01	Tank, fresh water
601238	Adaptor 1.25" MPT X 1.25" Barb
601239	Hose, 1.375" I.D., water tank fill
601709	Check valve, w/rubber flap (over flow)
600139	Check valve, brass
601061-01	Water pump, Shurflo
601668	Filter, pre water pump
601392	City water hook-up w/regulator
601733	Hose, 36" vinyl riser (used on galley slide out)

FITTINGS

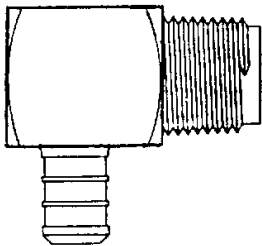

601698-04
Elbow, 1/2" barb
x 1/2" MPT

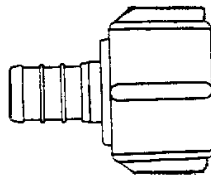

601698-03
Coupler, 1/2" barb
x 1/2" FPT

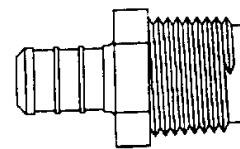

601698-02
Coupler, 1/2" barb
x 1/2" MPT

(continued)

2000 350/355 XL LAND YACHT

PLUMBING FRESH WATER-FITTINGS

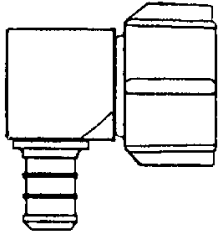

601698-05
Elbow 1/2" barb x
1/2" FPT

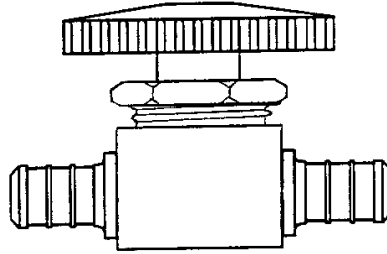

601698-07
Shut-off, 1/2" barb x
1/2" barb

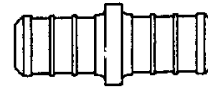

601698-08
Coupler
1/2" x 1/2" barb

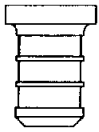

601698-09
Plug, 1/2" barb

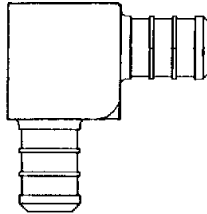

601698-10
Elbow 1/2" barb x
1/2" barb

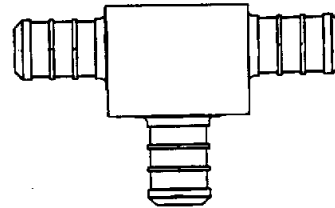

601698-11
Tee, 1/2" x 1/2" x
1/2" barb



601698-15
Crimp ring, 1/2
E-Pex, 1/2" (black)

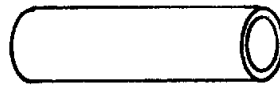

601698-01
E-Pex tube, 1/2"

(continued)

2000 350/355 XL LAND YACHT

PLUMBING FRESH WATER-FITTINGS



601698-16
Crimp ring, $\frac{3}{4}$ "
E-Pex, black



601698-12
E-Pex tube, $\frac{3}{4}$ "

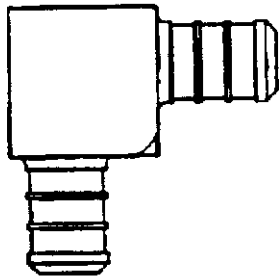

601698-13
Elbow, $\frac{3}{4}$ " x $\frac{3}{4}$ " barb

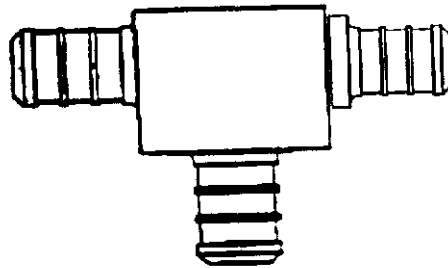

601698-18
Tee, $\frac{3}{4}$ " x $\frac{1}{2}$ " x $\frac{3}{4}$ " barb

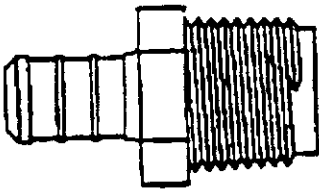

601698-19 Coupler
 $\frac{3}{4}$ " barb x $\frac{3}{4}$ " MPT

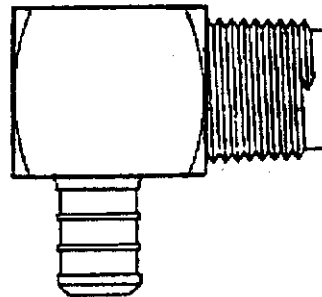

601709 Elbow
 $\frac{1}{4}$ " barb x $\frac{3}{4}$ " MPT

2000 350/355 XL LAND YACHT

PLUMBING FRESH WATER-FAUCETS

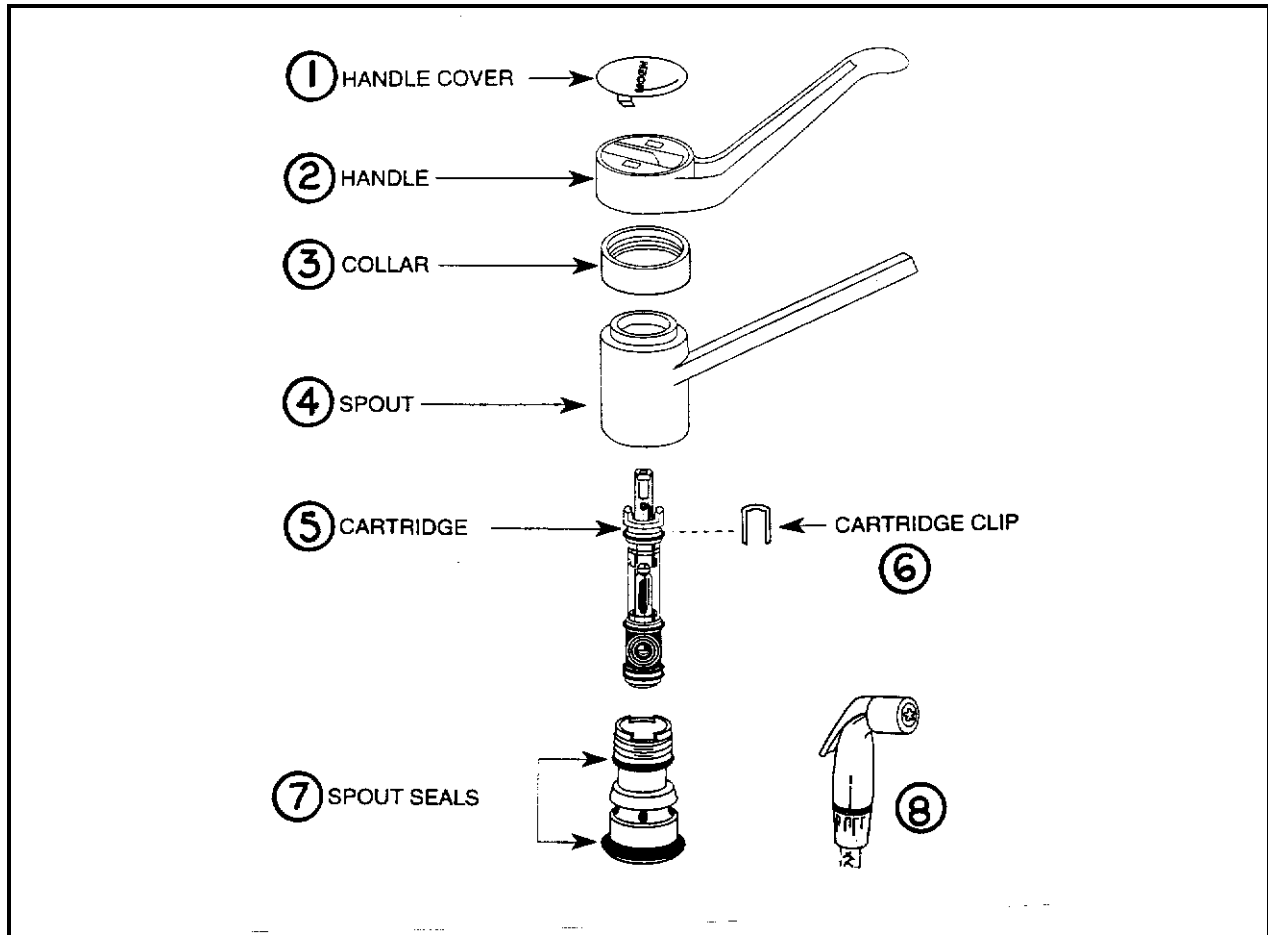

601705FAUCET, GALLEY, MOEN #7215S

- | | |
|---------------|--------------------------------|
| 1) 601705-972 | Handle cover, sand |
| 2) 601705-444 | Handle, sand |
| 3) 601705-694 | Collar, sand |
| 4) 601705-915 | Spout, sand |
| 5) 601579-106 | Cartridge, Moen |
| 6) 601579-105 | Clip, cartridge retainer |
| 7) 601705-117 | Spout seals, Moen 7215S |
| 8) 601705-873 | Spray head/hose assembly, sand |

2000 350/355 XL LAND YACHT

PLUMBING FRESH WATER-FAUCETS

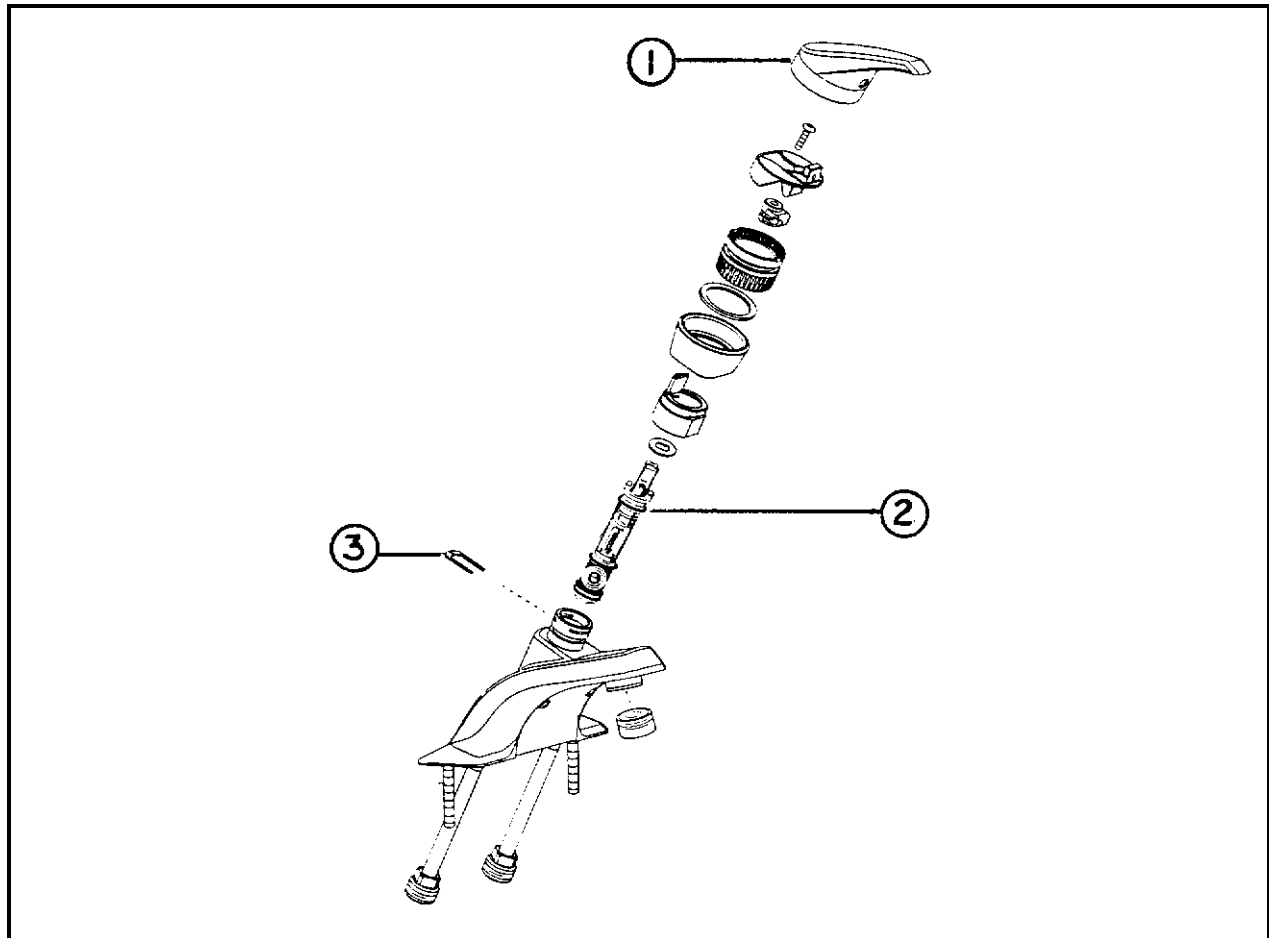

690390-02Faucet, lavatory, Moen, brass/chrome

- | | |
|---------------|---------------|
| 1) 690390-100 | Lever handle |
| 2) 601579-105 | Cartridge |
| 3) 601579-104 | Retainer clip |

2000 350/355 XL LAND YACHT

PLUMBING FRESH WATER-FAUCETS

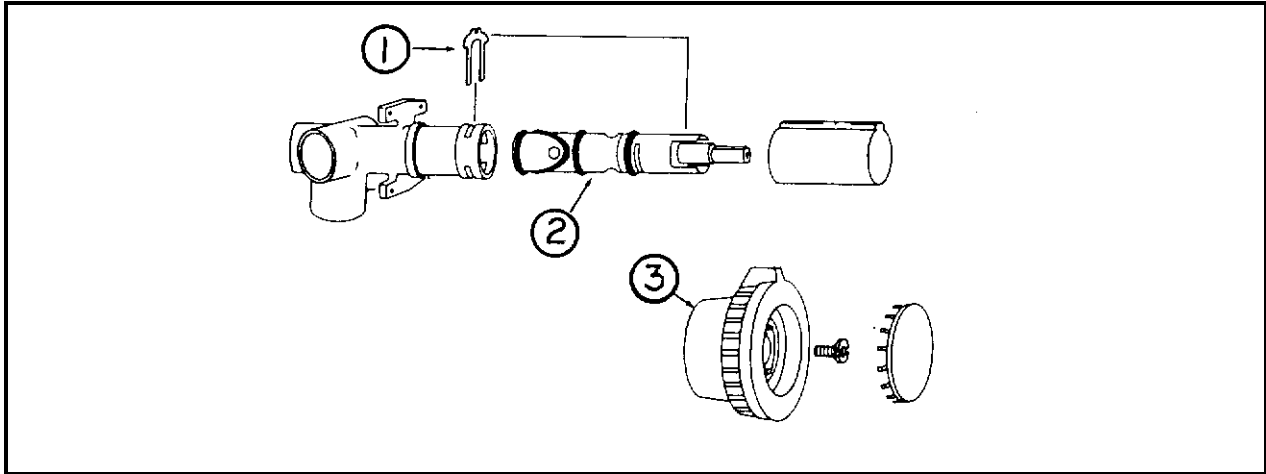

601420-02Faucet, shower

- 1) 000883
- 2) 601420-100
- 3) 001041

Retainer clip
Cartridge
Handle

- 601358-100
- 600330
- 600332

Shower head , chrome
Shower hose, chrome
Vacuum breaker, chrome

2000 350/355 XL LAND YACHT

PLUMBING FRESH WATER-FAUCETS

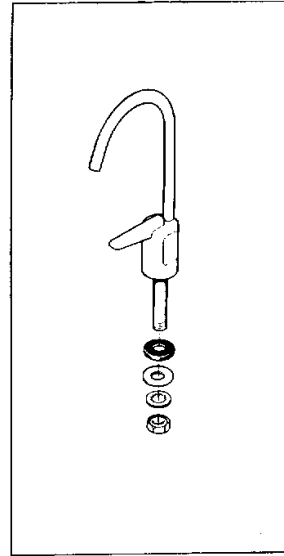
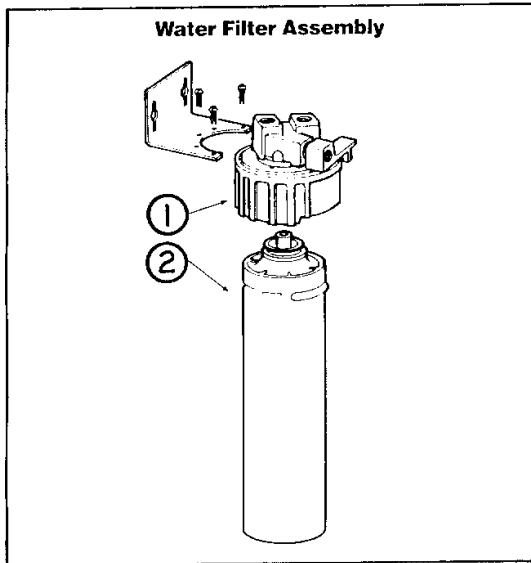

- | | | | |
|-----------|--------------------|--------|---------------|
| 1) 005273 | Head, water filter | 601401 | Faucet, water |
| 2) 960112 | Cartridge, filter | | |

2000 350/355 XL LAND YACHT

PLUMBING DRAIN SYSTEM

601726-01	Holding tank, gray
601725-01	Holding tank, black
601441	Tank flush, no-fuss(vacuum breaker and check valve)
601441-01	Nozzle, tank mounted, no-fuss flush
601197-01	Water hook-up, chrome, black tank flush
601607-08	Sewer hose, 20', w/hose adaptor
203201	Pan, sewer hose storage

FITTINGS-BELOW FLOOR

601470	Dump valves, Valterra(includes both valves and drop out)
195329-229	Reducer adapter, 3" to 1.5"
600820	3" Single socket, 90 degree
601160-02	Pipe, ABS, 1.5"
601160-04	Pipe, ABS, 3.0"
601607-07	Bayonet cap, 3"

2000 350/355 XL LAND YACHT

PLUMBING DRAIN SYSTEM-ABOVE FLOOR

- 601266 Closet flange, 3" x 4", slip fit, tank to toilet adp.
- 203180-01 Shower stall
601727 Drain, shower, 2"w/grid
- 200406-06 Lavy bowl, oval-includes tail, basket and stopper
- 601633-06 Sink, galley, porcelain, almond
600968 Basket strainer
- 601700 Hose, drain, Kaf-Flex 1.5", galley slide out

FITTINGS, 1.5' PLASTIC

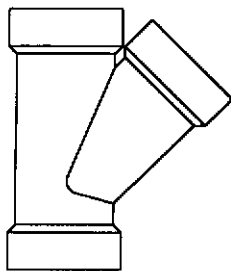

**WYE
#2301
600094**

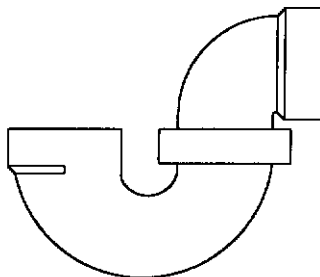

**P-TRAP
1.5" W/O SLIP NUT
600144**

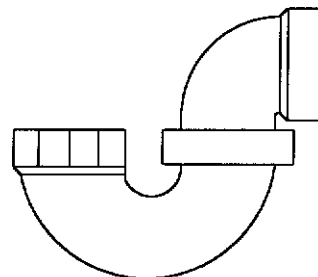

**P-TRAP
1.5" WITH SLIP NUT
600622**

(continued)

2000 350/355 XL LAND YACHT

PLUMBING FITTINGS, 1.5" PLASTIC

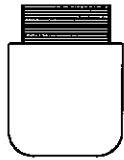

VENT 1.5"
600538



PLUG 1.5"
600155

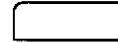

CAP 1.5"
601677

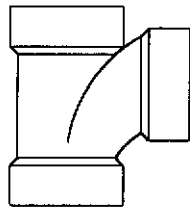

TEE-SANITARY
1.5"
600156

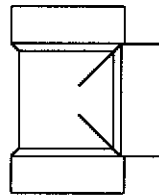

TEE-BI DIRECTIONAL
CLEAN-OUT 1.5"
601318

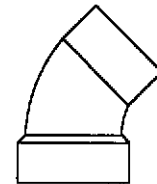

ELBOW 45D
LONG ST
600027

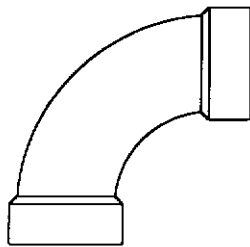

ELBOW 90D
LONG TURN
600035

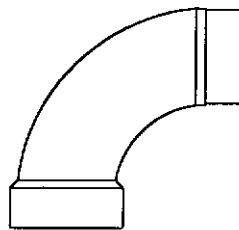

ELBOW 90D
LONG ST
600431

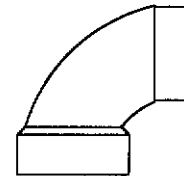

ELBOW 90D
SHORT ST
600662

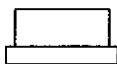

REDUCER 1.5" TO 1.25"
601263



ADAPTER
601676

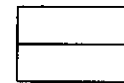

ADAPTER
W/FEMALE THREADS
600308

(continued)

2000 350/355 XL LAND YACHT

PLUMBING

FITTINGS, 1.5" PLASTIC

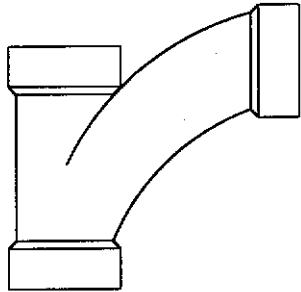

**WYE 1.5"
1/8" BEND
600182**



**COUPLING
1.5"
600227**

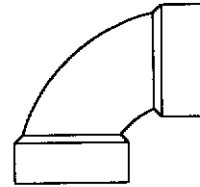

**ELBOW 90D
SHORT SWEEP
601636**

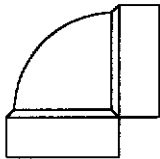

**ELBOW VENT
90D
600033**

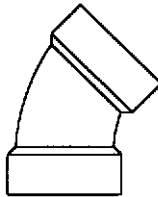

**ELBOW 45D
LONG TURN
600030**

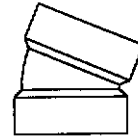

**ELBOW 22.5D
SHORT TURN
600116**

2000 350/355 XL LAND YACHT

PLUMBING

THETFORD, AQUA MAGIC GALAXY, PARCHMENT

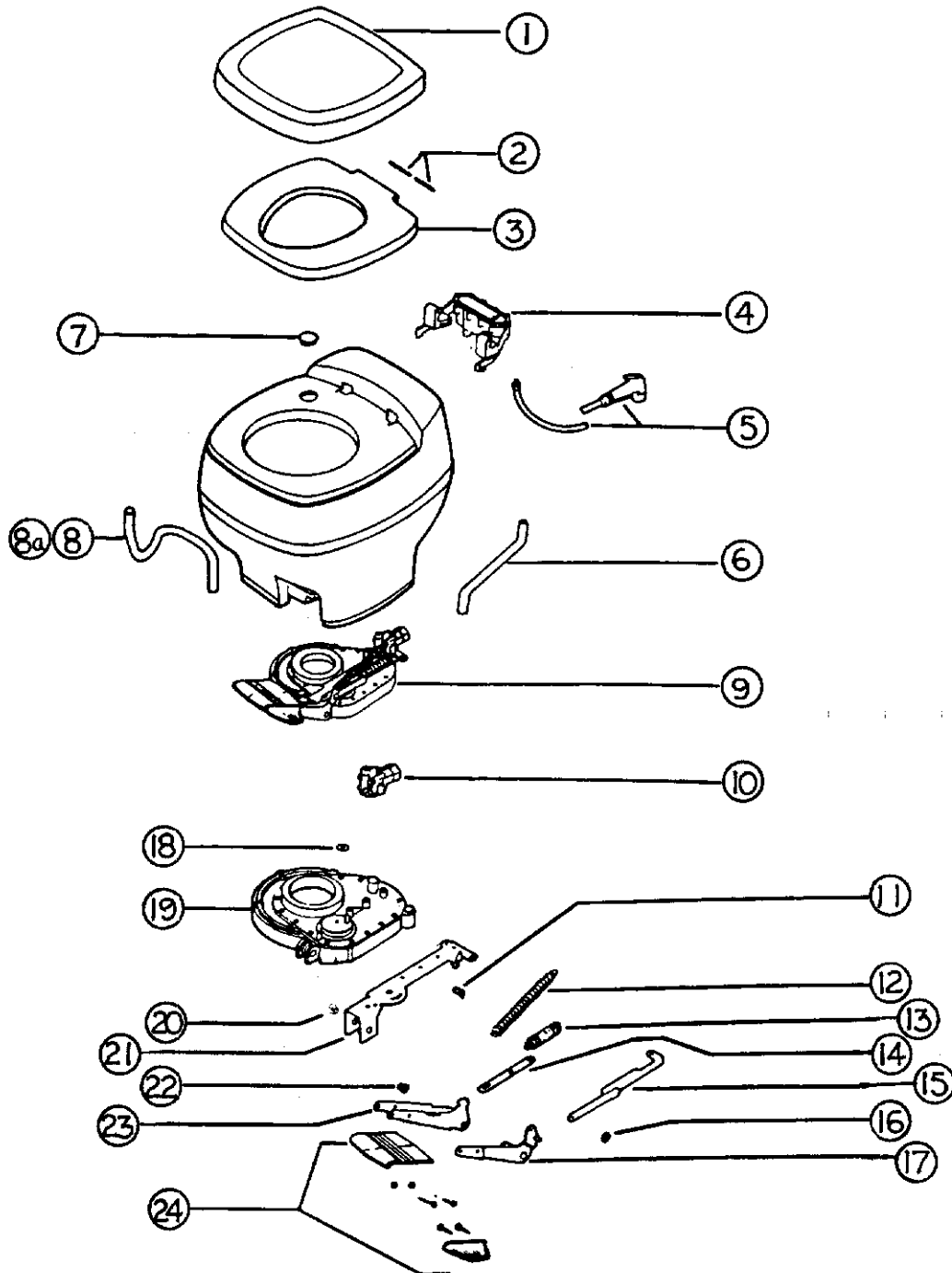

2000 350/355 XL LAND YACHT

PLUMBING

THETFORD, AQUA MAGIC GALAXY, PARCHMENT

690327-02 Toilet complete, Aqua Magic Galaxy, high

- 1) 020925 Padded seat cover, parchment
- 2) 012986 Hinge pin
- 3) 1626457 Seat, parchment
- 4) 008217 Vacuum breaker w/water saver, parchment
- 5) 008993 Water saver package
- 6) 003728 Water supply tube
- 7) 003895 Hole plug, parchment
- 8) 003729 Trap tube, 20", low style
- 8a) 003727 Trap tube, 27", high style
- 9) 024203 Mechanism, parchment
- 10) 009868 Ball valve replacement package
- 11) 002391 Drive arm assembly
- 12) 002802 Spring, ball valve return
- 13) 002801 Spring
- 14) 008986 Push link
- 15) 002796 Drive arm
- 16) 002394 Ring, retainer
- 17) 009421 Pedal arm assembly
- 18) 008034 Retainer ring, 1/4"
- 19) 020929 Base and cover assembly
- 20) 003749 Bushing, mechanism
- 21) 012593 Lever plate
- 22) 003749 Bushing, mechanism
- 23) 019266 Pedal arm
- 24) 020930 Double pedal package

2000 350/355 XL LAND YACHT

SAFETY EQUIPMENT

510781	Detector, smoke #1056 w/silencer
511343	Detector, carbon monoxide-9 volt
511309	Detector, LPG
510734	Alarm, back-up
381069	Seat belt kit, cocktail chair
453676	Bracket, dinette seat belt, LH-double
453677	Bracket, dinette seat belt, RH-single
690381-01	Fire extinguisher 10 B:CUL
690381-02	Fire extinguisher 10 B:CULC(Canadian)
380188	Emergency warning triangle, set of 3

2000 350/355 XL LAND YACHT

SEALER, GASKETS, PAINT, ADHESIVES GASKETS



1) 381663



2) 365237-01



3) 365232



4) 365214



5) 201260



6) 381640



7) 381665



8) 365013-01

- | | |
|--------------|---|
| 1) 381663 | Gasket, lower compartment door |
| 2) 365237-01 | Seal, dust, compartment door edge |
| 3) 365232 | Seal, main door/compartment door jamb |
| 4) 365214 | Gasket, seal-compartment door hinge and main doorjamb |
| 5) 201260 | Insert, windshield gasket, rubber |
| 6) 381640 | Gasket, windshield, includes center strip |
| 7) 381655 | Gasket, window to body, door jamb |
| 8) 365013-01 | Gasket, screen door, low-density foam |

2000 350/355 XL LAND YACHT

SEALS

Sealer, gaskets, paint, adhesives

GASKETS-SE-GI WINDOWS



1) 371366-103



2) 371366-102



3) 371366-104



4) 371366-105

- | | |
|---------------|--------------------------------|
| 1) 371366-103 | Track, window screen, Se-Gi |
| 2) 371366-102 | Track, sliding pane, Se-Gi |
| 3) 371366-104 | Wiper seal, vertical, Se-Gi |
| 4) 371366-105 | Screw cover, clamp ring, Se-Gi |

2000 350/355 XL LAND YACHT

SEALER, GASKETS, PAINT, ADHESIVES

SEALER

360209-02	Sealer, black, windshield
360052	Vulkem sealer, black,
360180	Sika flex #221
360268-01	Liqua Seal, roof, white
360281	Sealant, thermoplastic rubber(clear)
360216	Caulk, latex, brown
365001	Tape, double coated foam
360074	Sealant, GE RTV, white
360001	Butyl sealant
360002	Vulkem sealant, gray
360176	Sealant, almond, bathroom
360210	Sealant, Paralastic #4334-04 (refrigerator compartment sealer)
360283	Silicone sealer, Corian bone
360190	Sealant, white
360286	Sealant, gray

2000 350/355 XL LAND YACHT

SEALER, GASKETS, PAINT, ADHESIVES

ADHESIVES

702791	Border adhesive
800639-02	Adhesive, Oak plank flooring
360270	Adhesive spray, sta-put, ceiling panels (reference only, not available for shipment)
360261	Glue, urethane

PAINT

Each vehicle has been provided with a sheet listing the paint color codes on that particular motorhome. Also, each motorhome is shipped with touch-up paint for each color. A back up color chart for each motorhome is kept in Airstream's files. If calling Airstream for this information ask for "Sales" and have, the serial number available for them.

360208	Stain, gal, medium Oak
365244	Lacquer, clear, used on wood

MISCELLANEOUS

360179	Undercoat, Pennzoil II
6000329	Tape, silver, 2" wide
200518	Spline, gray, screen insert
380079	Screen, gray

2000 350/355 XL LAND YACHT

UPHOLSTERY/FOAM/MATTRESS

- 702675 Mattress, 60 x 80" w/45degree corner, slide out
702674 Mattress, 60 x 75" w/45 degree corner
701611 Pillow 21 x 31"
- *702676-399 Bedspread , J model, Roman Sands
- 964285 Head board, 60"wide
- *703022-399 Swivel chair, Roman Sands
- *702800-399 Sofa, jackknife, 68", slide out, Roman Sands
- 702897-03 Seat, driver, power w/belts
702898-02 Seat, passenger, non-power, w/belts

*Changing the-(dash) number to:

- 318 = Blue Bayou
- 258 = South Beach
- 248 = Vintage Leaf
- 379 = Mosaic Blue

2000 350/355 XL LAND YACHT

UPHOLSTERY/FOAM/MATTRESS

PILLOW KIT BLUE BAYOU

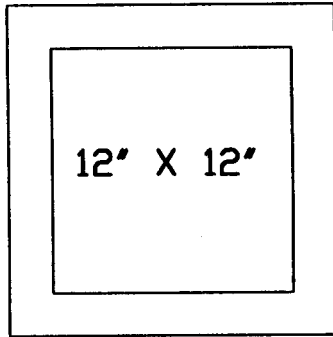

702896-01 Lounge accent pillow

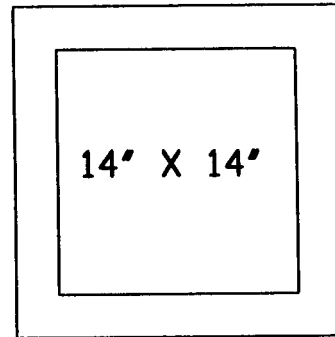

702896-02 Bedroom accent pillow

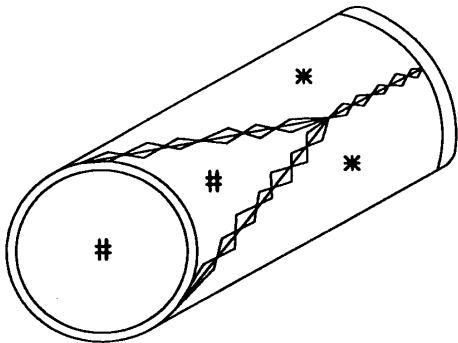

702896-03 Bedroom accent pillow

2000 350/355 XL LAND YACHT

UPHOLSTERY/FOAM/MATTRESS

PILLOW KIT- SOUTH BEACH

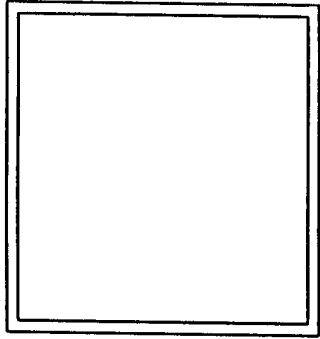

702926-01 Lounge accent pillow

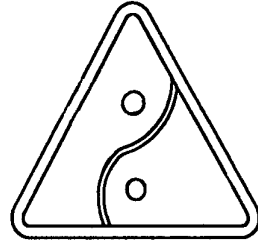

702926-02 Bedroom accent pillow

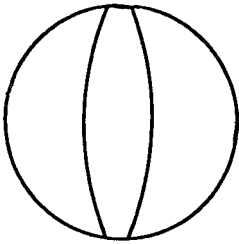

702926-03 Bedroom accent pillow

2000 350/355 XL LAND YACHT

UPHOLSTERY/FOAM/MATTRESS

PILLOW KIT-VINTAGE LEAF

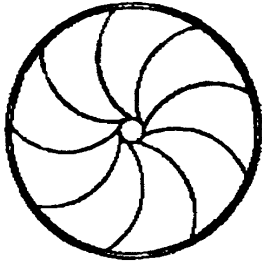

702932-01
Lounge Pillow

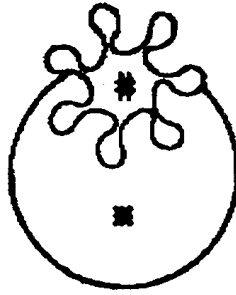

702932-02
Bedroom Pillow

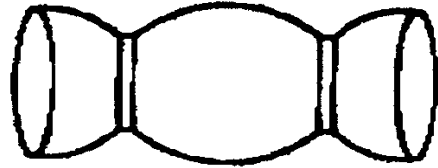

702932-03
Bedroom Pillow

2000 350/355 XL LAND YACHT

UPHOLSTERY/FOAM/MATTRESS

PILLOW KIT-MOSAIC BLUE

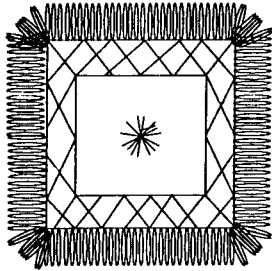

703033-01 Lounge
accent pillow

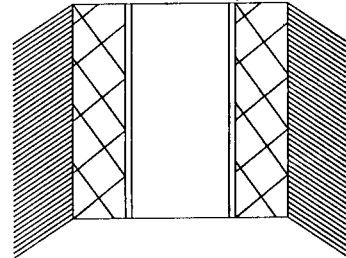

703033-02 Lounge
accent pillow

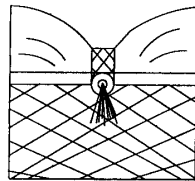
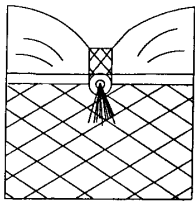

703033-03 703033-04(chair)
Lounge accent pillows

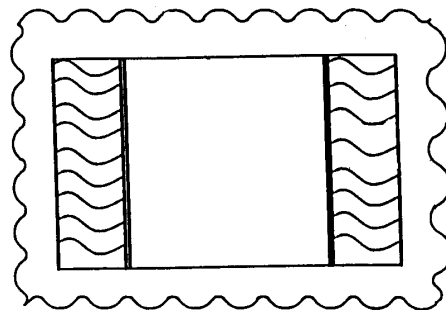

703033-05 Sham, Queen

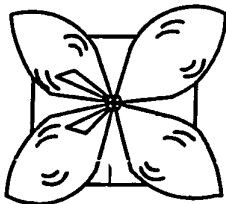

703033-06 Bedroom
accent pillow

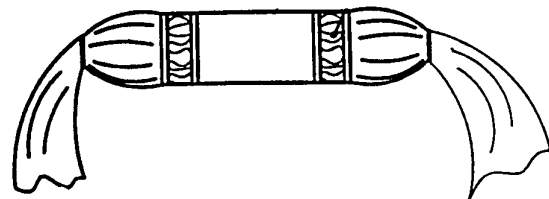

703033-07 Bedroom accent pillow

2000 350/355 XL LAND YACHT

UPHOLSTERY/FOAM/MATTRESS

PILLOW KIT- TROPICAL ISLE

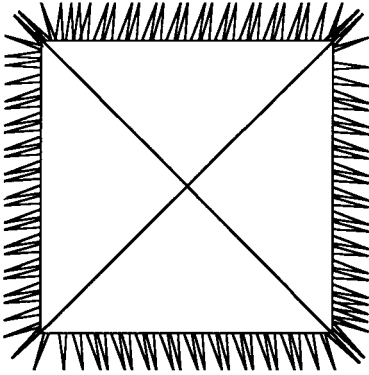

702978-01 Sofa pillow

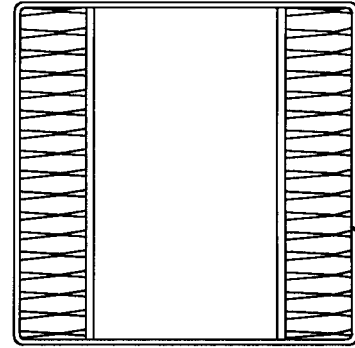

702978-02 Bedroom
accent pillow

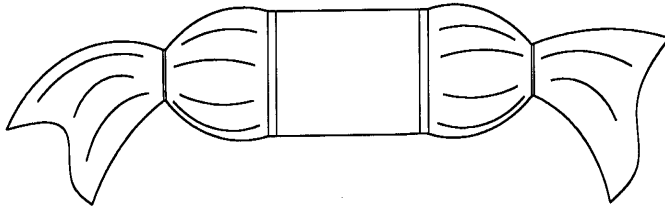

702978-03 Bedroom accent pillow

2000 350/355 XL LAND YACHT

UPHOLSTERY/FOAM/MATTRESS

PILLOW KIT- ROMAN SANDS

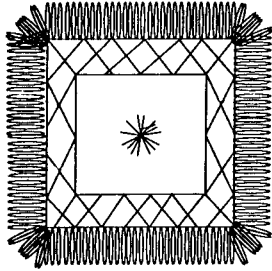

703032-01 Lounge accent pillow

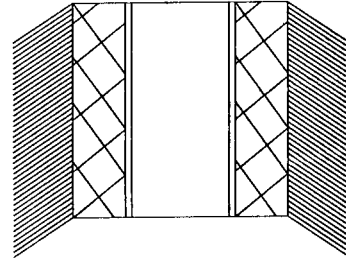

703032-02 Lounge accent pillow

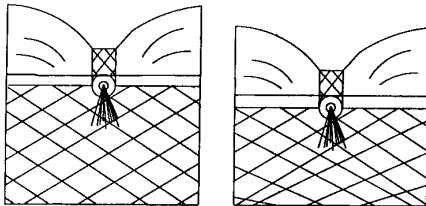

703032-03 Lounge accent pillows

703032-04(chair)

703032-05 Sham, Queen

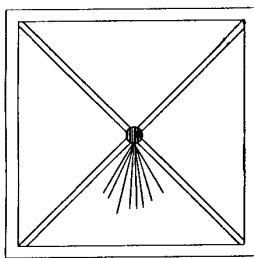
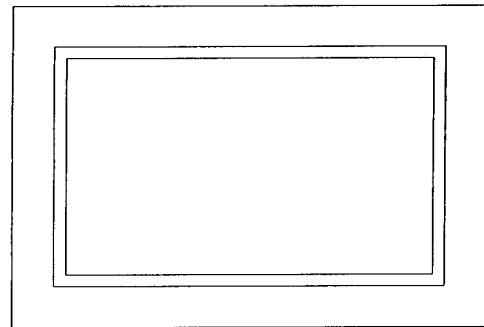

703032-06 Bedroom accent pillow

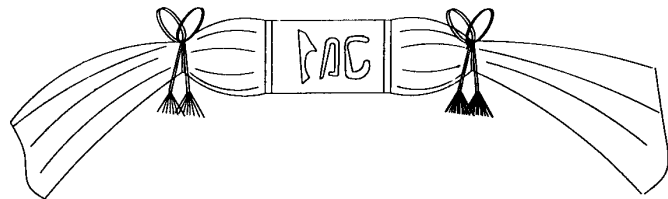

703032-07 Bedroom accent pillow

2000 350/355 XL LAND YACHT

UPHOLSTERY/FOAM/MATTRESS

964537	Upholstered back, aft dinette
702464-17	Foam, dinette, upper back, RH, 32.25"
702464-06	Foam, dinette, lower back, 32.25"
964707	Upholstered back, forward dinette
702464-20	Foam, dinette, upper back, LH, 38.25"
702464-07	Foam, dinette, lower back, 38.25"
998070	Cover, seat, side dinette
702464-08	Foam, dinette, aft seat, 32.25"
702464-11	Foam, dinette, forward seat, 38.25"
998071	Cover, back, side dinette

2000 350/355 XL LAND YACHT

VENTS/FANS

381207-02	Vent w/screen, refrigerator, roof
511152-01	Vent cover, exterior, range exhaust
381541-06	Roof vent w/power lift
381541-02	Switch, roof vent
690266-01	Ventilator, round, bath
381153-01	Vent, Jensen #757
381450	Vent, roof, Fantastic#6000RBT
511376	Fan, defrost, oscillating
203148-01	Skylight, heavy duty, 14.5" x 22"
203148-02	Trim, inner skylight dome

2000 350/355 XL LAND YACHT

WOOD/INTERIOR TRIM

801261	Paneling, interior wall, 1/8" x 4' x 8', Antiquity Buff
203159-02	Trim, divider bar, interior panels, Antiquity Buff
800507-01	Paneling, luan, 1/8"x 4' x 8'
800397-01	Cedar, planked, 5/32"x 4' x 8'
201728-01	Extrusion, ceiling trim retainer
201728-04	Extrusion, ceiling trim
801283-01	Paneling 1/2" x 4'x8', G2S, Antiquity Buff
801274	Paneling 1/2" x 4'x8', G1S, Antiquity Buff
801180-004	Paneling 1/2" x 4' x 7', G2S, Oak/Oak
801179-004	Paneling, 1/2" x 4' x 7', G1S, Oak/raw
801182-004	Paneling 5/32" x 4' x 7', G2S, Oak/Oak
801181-004	Paneling 5/32" x 4' x 7', G1S, Oak/raw
801284-004	Paneling 1/2" x 4' x 8', G2S, Oak/Antiquity Buff
801283	Paneling 1/2" x 4' x 8', G2S, Ant.Buff/Ant.Buff
801229	Laminate, Oak, 4'x8'
365251-01	Tape, seam, Antiquity Buff, 1 1/8" wide
365251-02	Tape, seam, Antiquity Buff, 8" wide
365251-03	Tape, seam, Antiquity Buff, 12" wide
800631	Handrail, Oak, 23"

2000 350/355 XL LAND YACHT

WOOD/INTERIOR



1) 801206-01



2) 964152-01

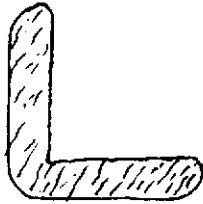

3) 801175-03



4) 800571-01

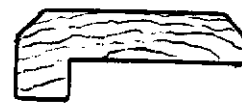

5) 800617-01



6) 801172-01

6a) 801172-03



7) 801173-03



8) 801173-04

1) 801206-01

Molding, floor, Oak, 43"

2) 964152-01

Molding, chair rail, Oak

3) 801175-03

Molding, corner, Solitude, 2452-x

4) 800571-01

Molding, Oak, flat 1/4"x33/64"x80"

5) 800617-01

Molding, Wainscoat, Oak

6) 801172-01

Molding, flexible corner, Oak

6a) 801172-03

Molding, flexible corner, Solitude

7) 801173-03

Molding, flat radius, .88" Oak

8) 801173-04

Molding, flat radius, 1.13" Oak

(trim continued)

2000 350/355 XL LAND YACHT

WOOD/INTERIOR TRIM



1) 800573-01



2) 800572-01



3) 201728-04

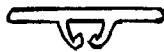

4) 201728-01



5) 203159-02

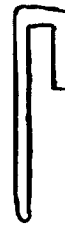

6) 201666

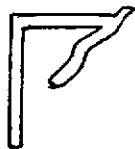

7) 201790-01



8) 203138-01

8a) 203138-02

- | | |
|---------------|--|
| 1) 800573-01 | Molding, door edge 1 3/32" x 80" |
| 2) 800572-01 | Molding, panel edge, Oak 23/32" x 80" |
| 3) 201728-04 | Extrusion, ceiling trim |
| 4) 201728-01 | Extrusion, ceiling trim retainer |
| 5) 203159-02 | Trim, divider bar, interior panels, Antiquity Buff |
| 6) 201666 | Molding , J 3/16", plastic |
| 7) 201790-01 | Molding, cove, white, ceiling to wall |
| 8) 203138-01 | Extrusion, wall, plastic, white (panel edging) |
| 8a) 203138-02 | Extrusion, wall, plastic, brown (panel edging) |

2000 350/355 XL LAND YACHT

WOOD/INTERIOR TRIM

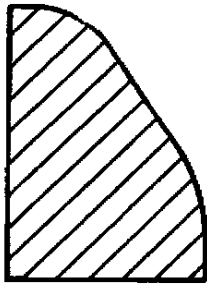

1) 800576-01



2) 801189



3) 964651

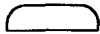

4) 801173-014

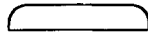

5) 801173-024

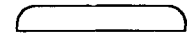

6) 801173-034

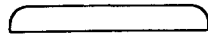

7) 801173-044

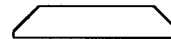

8) 801178-03

- | | |
|---------------|---|
| 1) 800576-01 | Molding, bath doorstep, Oak |
| 2) 801189 | Trim, bath doorjamb, Oak |
| 3) 964651 | Stile, bath hall |
| 4) 801173-014 | Flat molding, vinyl wrapped, Oak, .50 wide |
| 5) 801173-024 | Flat molding, vinyl wrapped, Oak, .75 wide |
| 6) 801173-034 | Flat molding, vinyl wrapped, Oak, .88 wide |
| 7) 801173-044 | Flat molding, vinyl wrapped, Oak, 1.13 wide |
| 8) 801178-03 | Flat molding, vinyl wrapped, Antiquity Buff |

SLIDE OUT ROOM INTERIOR TRIM

- | | |
|-----------|--|
| 964267 | Molding, decorative Oak, slide out trim, 84" |
| 964267-01 | Molding, decorative Oak, slide out trim, 120" |
| 964717 | Facia, decorative Oak, corner block, slide out |

2000 350/355 XL LAND YACHT

NOTES

