

AIRSTREAM

SAFARI TRAILER

Parts Book

2000



TABLE OF CONTENTS

SECTION I - SAFARI A through C

APPLIANCES

Air Conditioner	I-1
Furnace	I-1
Microwave	I-1
Range	I-1
Refrigerator	I-1
Water Heater	I-1

BODY

End shell, aft	I-3
End shell, front	I-5
Roof	I-7
CS wall, 27ft	I-9
RS wall, 27ft	I-11
RS wall, 25 sleep six "C"	I-13
CS wall, 25 sleep six "C"	I-15
CS wall, 25 "A&B"	I-17
RS wall, 25 "A&B"	I-19
RS wall, 23 "C"	I-21
CS wall, 23 "C"	I-23
Body interior	I-24

CHASSIS

Axles	I-25
Shocks	I-25
Tire & wheel	I-25
Jacks	I-25
Step	I-25
Rear bumper/hose carrier	I-25
Underbelly metal	I-26
Coupler, hitch	I-26
Brakes, 12"	I-27

TABLE OF CONTENTS

SECTION II

D through E

[DECALS/EXTERIOR TRIM](#) II-1

DOORS/WINDOWS/AWNING

[Doors](#) II-2

[Windows](#) II-3

[Awning](#) II-3

[DRAPES/BLINDS/VALANCES](#) II-4

ELECTRICAL

[110 volt](#) II-5

[12 volt](#) II-6

ENTERTAINMENT

[Radio/antenna](#) II-8

TABLE OF CONTENTS

SECTION III

F through H

FASTENERS (common fasteners available locally are not listed)

Rivets	III-1
------------------------------	-------

FLOOR COVERING

Carpet	III-3
Mats	III-3

FURNITURE

Interior doors	III-4
Mirrors	III-5
Drawer	III-5
Rear bedroom	III-6
Bath	III-7
Galley	III-10
Lounge	III-14

HARDWARE

Exterior locks/hinges	III-17
Interior drawer slides/hinges latches	III-21
Bath, table accessories	III-24
Awning hardware	III-26

TABLE OF CONTENTS

SECTION IV

L through Z

[LABELS and TAGS](#) IV-1

PLUMBING

[LPG](#) IV-2

[Fresh water](#) IV-3

[Faucets](#) IV-5

[Drain water](#) IV-8

[Toilet](#) IV-12

[SAFETY EQUIPMENT](#) IV-14

[SEALER/GASKETS/PAINT](#) IV-15

[UPHOLSTERY/FOAM/MATTRESS](#) IV-16

[VENTS/FANS](#) IV-17

[WOOD/LAMINATES/TRIM](#) IV-18

TABLE OF CONTENTS

SECTION I - SAFARI A through C

APPLIANCES

Air Conditioner.....	I-1
Furnace	I-1
Microwave.....	I-1
Range	I-1
Refrigerator.....	I-1
Water Heater.....	I-1

BODY

End shell, aft	I-3
End shell, front	I-5
Roof	I-7
CS wall, 27ft.....	I-9
RS wall, 27ft.....	I-11
RS wall, 25 sleep six "C"	I-13
CS wall, 25 sleep six "C"	I-15
CS wall, 25 "A&B"	I-17
RS wall, 25 "A&B"	I-19
RS wall, 23 "C"	I-21
CS wall, 23 "C"	I-23
Body interior	I-24

CHASSIS

Axles.....	I-25
Shocks	I-25
Tire & wheel	I-25
Jacks.....	I-25
Step	I-25
Rear bumper/hose carrier.....	I-25
Underbelly metal.....	I-26
Coupler, hitch	I-26
Brakes, 12"	I-27

2000 SAFARI APPLIANCES

195329-143	Air conditioner, 11, 000 Dometic
690323-02	Air conditioner, 13, 500 Dometic
961270	Pan Assembly, drain, air conditioner
690323-03	Heat strip, Dometic air conditioner
690323-100	Shroud, exterior, Penquin
690323-05	Air box/return grill
690274-01	Furnace, Hydroflame, 8531-IV, 27ft. Safari
690274-04	Furnace, Hydroflame, 8525-IV, 23ft & 25 ft
600247	Hose, 4", flex heat duct
600193	Hose, 2", flex heat duct
511228	Thermostat, furnace, off white
690407-01	Microwave, Dometic, black
690407-02	Trim kit, Dometic microwave, black
690345-01	Micro wave, convection, Sharp-opt.
690345-03	Trim ring, Sharp convection
690396-01	Range/oven, 22" Maytag
690396-03	Bi-fold cover
690388-01	Refrigerator, Dometic Americana, RM2852RH 27ft. Safari
964385-24	Door panel, refrigerator, 25.13" x 15.25
690388	Refrigerator, Dometic, RM2652RH 23 & 25ft.Safari
964385-13	Door panel, refrigerator, 25.13 x 17.50
690199	Water heater, electronic ignition
091959	Switch package, water heater

2000 SAFARI

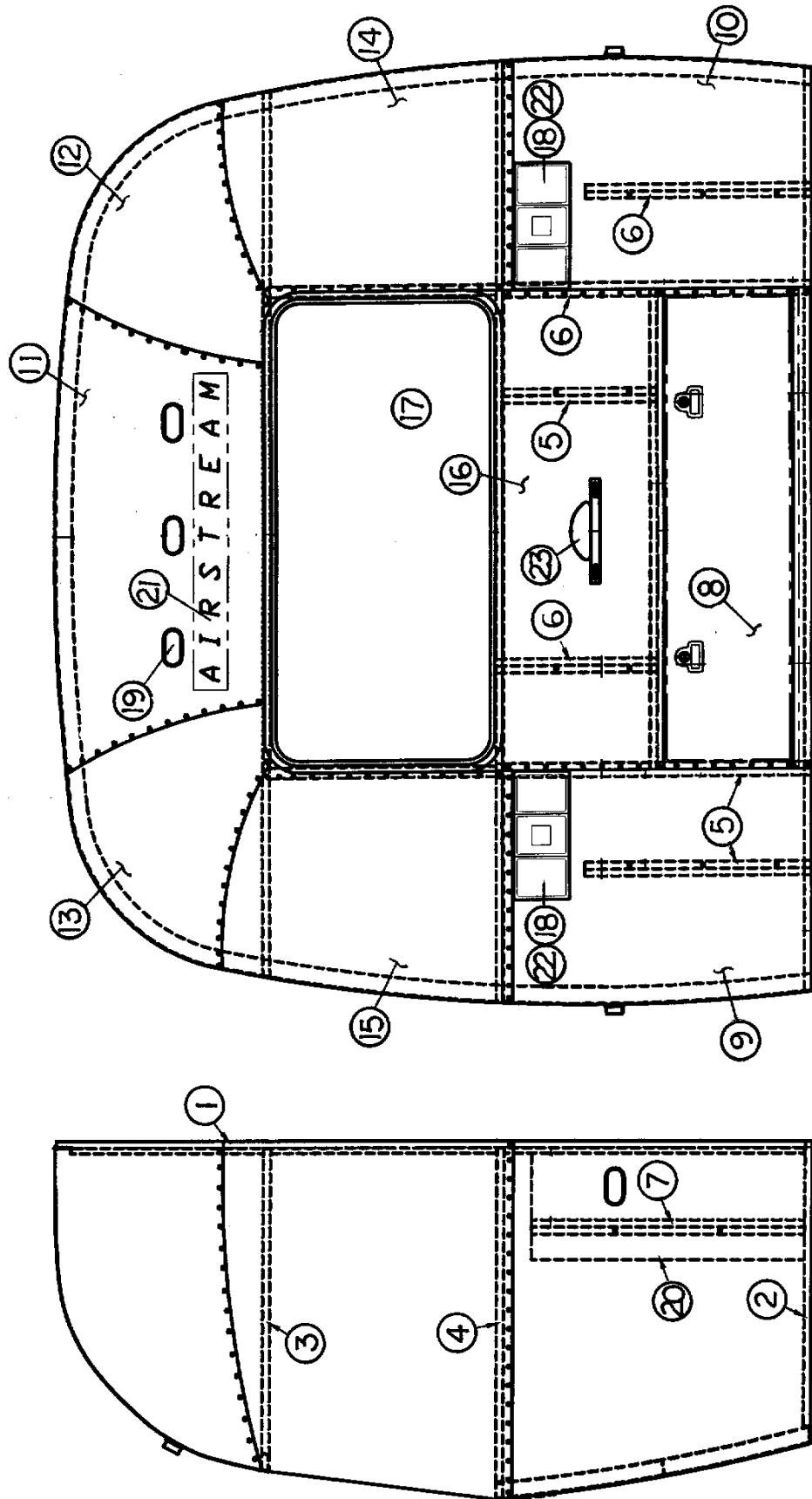

2000 SAFARI

BODY-AFT END

*27 & 25 FT A & B MODELS SHOWN

921180-04	End shell complete, 25&27ft."B"
921180-01	End shell complete, 25&27ft."A"
1) 114993	End bow
2) 114676	Floor bow
3) 114678	Upper window bow
4) 114677	Lower window bow
5) 114505-01	Support, lower end, LH
6) 114505-02	Support, lower end, RH
7) 101315	Brace, vertical rear
8) 921159-01	Trunk door assembly, twin bed only
9) 114895	Segment, #29
10) 114894	Segment, #28
11) 114893	Segment #25
12) 114890	Segment #26
13) 114891	Segment #27
14) 114889	Segment, center right
15) 114888	Segment, center left
16) NPN Alum. sheet, .050 x 19.0 x 51.0	(cut from 114880-307)
17) 371362-06	Window, rear egress, 49.63 x 24.19
18) 500500	Taillight complete
19) 510111	Clearance light, red
20) NPN Alum. sheet, .040x12.0x29.0	(cut from 114880)
21) 386051	Decal "AIRSTREAM" 32"
22) 201462	Pocket, ABS taillight
23) 500053	Light and license plate holder

*The 25 & 23 ft. corner bed models have a different rear window and a smaller rear access door.

371362-09	Window, rear egress, Safari "C"
100679	Access door assembly, rear, Safari "C"

2000 SAFARI

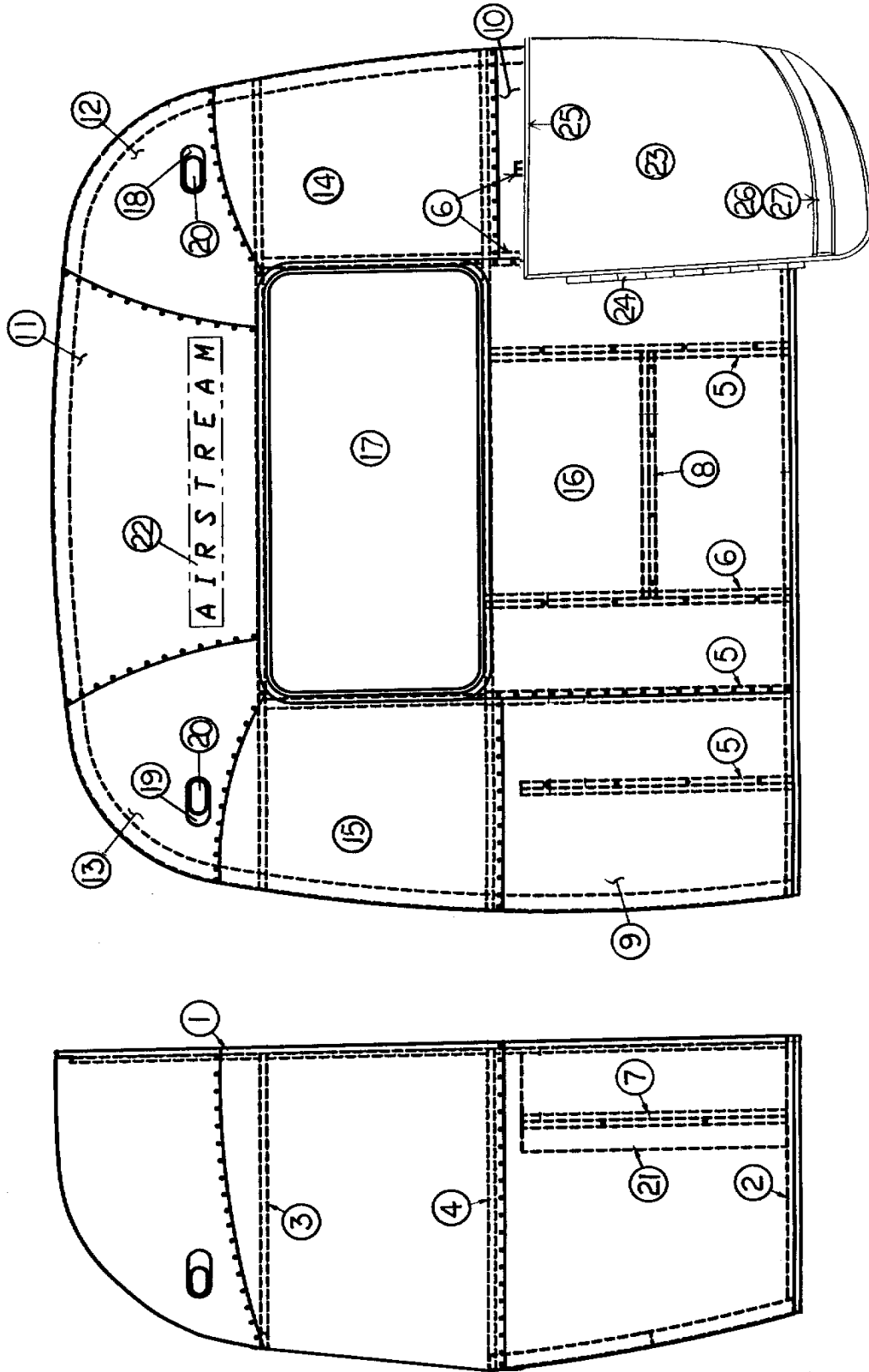

2000 SAFARI BODY-FRONT END

921179-01	End shell complete
1) 114993	End bow
2) 114676	Floor bow
3) 114678	Upper window bow
4) 114677	Lower window bow
5) 114505-01	Support, lower end, LH
6) 114505-02	Support, lower end, RH
7) 101315	Brace, vertical rear
8) 104408	Extrusion, Z rib
9) 114895	Segment, #29
10) 114894	Segment, #28
11) 114893	Segment #25
12) 114890	Segment #26
13) 114891	Segment #27
14) 114889	Segment, center right
15) 114888	Segment, center left
16) NPN Alum. sheet, .050 x 19.0 x 51.0	(cut from 114880-307)
17) 371362-05	Window, 49.63 x 24.19", Safari
18) 101177	Base , lamp, cast polished, RS
19) 101178	Base, lamp, cast polished, CS
20) 510112	Clearance light, amber
21)) NPN Alum. sheet, .040x12.0x29.0	(cut from 114880)
22) 386051	Decal "AIRSTREAM" 32"
23) 685366-100	Wrap protector, RS, Safari/Bambi
23a) 685365-100	Wrap protector, CS, Safari/Bambi
24) 381605-01	Hinge, stainless, wrap protector
25) 100742-01	Extrusion, mirror/wrap protector trim
26) 114460	Extrusion, rub rail
27) 201763-01	Insert, rub rail

2000 SAFARI

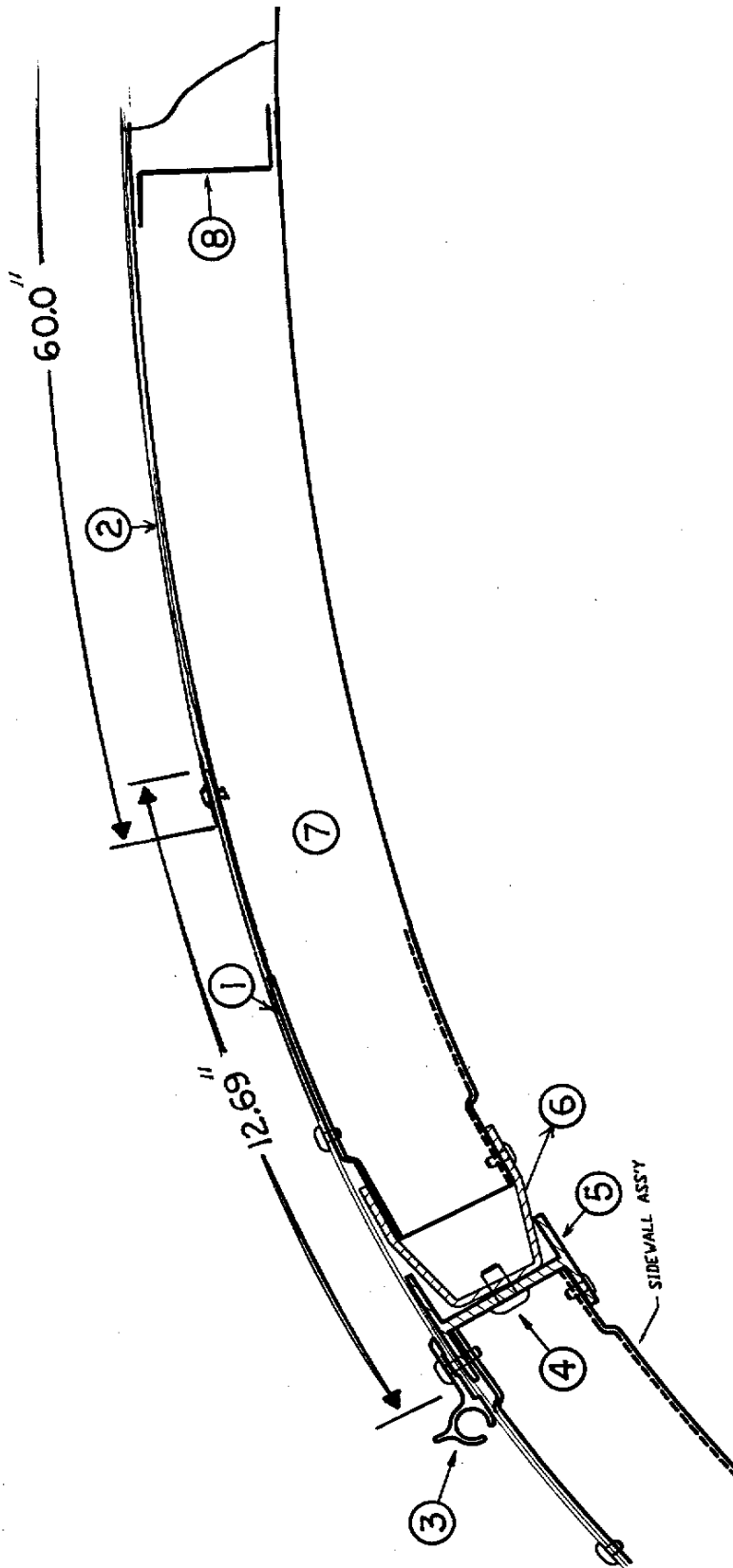

2000 SAFARI

BODY

ROOF-END VIEW

- | | |
|----------------|---|
| 1) 114669-307 | Alum. sheet, white, .032 x 12.69 x 307" |
| 2) 114489-262 | Alum. sheet, white, .032 x 60.0 x 262", 27ft. |
| 2a) 114489-198 | Alum. sheet, white, .032x60x198", 23&25ft. |
| 3) 114290 | Extrusion, awning/drip rail |
| 4) 340123-02 | Rivet, Huck, 3/16 x 1/2" |
| 5) 104707-05 | Extrusion." I" beam |
| 6) 114338-01 | Extrusion, roof corner |
| 7) 114668 | Roof bow |
| 8) 104408 | Extrusion, Z bar, horizontal |
- Not shown:
104948 Air deflector, between air cond. and refrigerator

2000 SAFARI

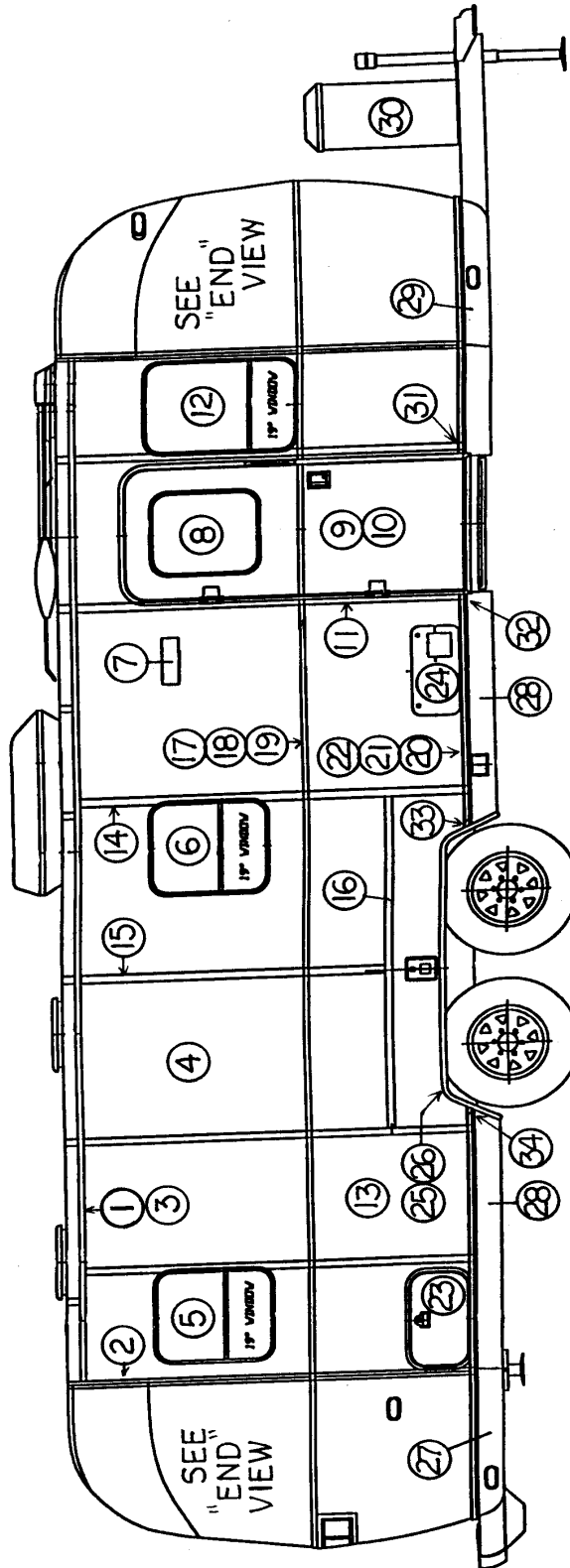

2000 SAFARI

BODY-27FT SAFARI, CS

(Hardware such as hinges, locks and latches are located

in the **hardware** section of this book)

- 1) 114290 Extrusion, awning/drip rail
- 2) 114993 Rib, end bow
- 3) 104707-05 Extrusion, "I" beam
- 4) 114880-262 Aluminum sheet, upper, .040 x 51 x 262"
- 5) 371362-02 Window, 19.25 x 22.75"
- 6) 371362-02 Window, 19.25 x 22.75"
- 7) 511017-11 Vent cover, range exhaust
- 8) 371362-01 Window, main door, 17.75 x 21.25"
- 9) 110067-07 Main door assembly
- 10) 114654 Screen door assembly
- 11) 114652 Jamb, main door
- 12) 371362-07 Window, 19.25 x 29.75"
- 13) 114879-262 Aluminum sheet, lower, .040 x 33 x 262"
- 14) 114387-01 Bow, Z rib, RH
- 15) 114387-02 Bow, Z rib, LH
- 16) 100986 Wheel well stiffener(floor channel)
- 17) 114328 Extrusion, belt line
- 18) 201912 Molding, chrome, belt line
- 19) 100034 "Z" bar, 48"
- 20) 114460 Extrusion, rub rail
- 21) 201763-01 Insert, rub rail, chrome, 1"
- 22) 100986 Floor channel
- 23) 100679-01 Access door w/jamb
- 24) 690274-09 Cover, Hydroflame furnace
- 25) 684936 Wheel well trim, inner, tandem axle
- 26) 684937¹ Wheel well trim, outer, tandem axle
- 27) 200545 Banana wrap, CS rear
- 28) 101131-01 Underbelly wrap, .024 x 22.5, pewter
- 29) 200543 Banana wrap, CS front
- 30) 104264-01 Cover, 30# LPG bottles w/o decal
- 31) 114465-01 Casting, rub rail end, door, RH
- 32) 114465-02 Casting, rub rail end, door, LH
- 33) 114466-01 Casting, rub rail end, wheel well, RH
- 34) 114466-02 Casting, rub rail end, wheel well, LH

¹Revised 7/21/2000

2000 SAFARI

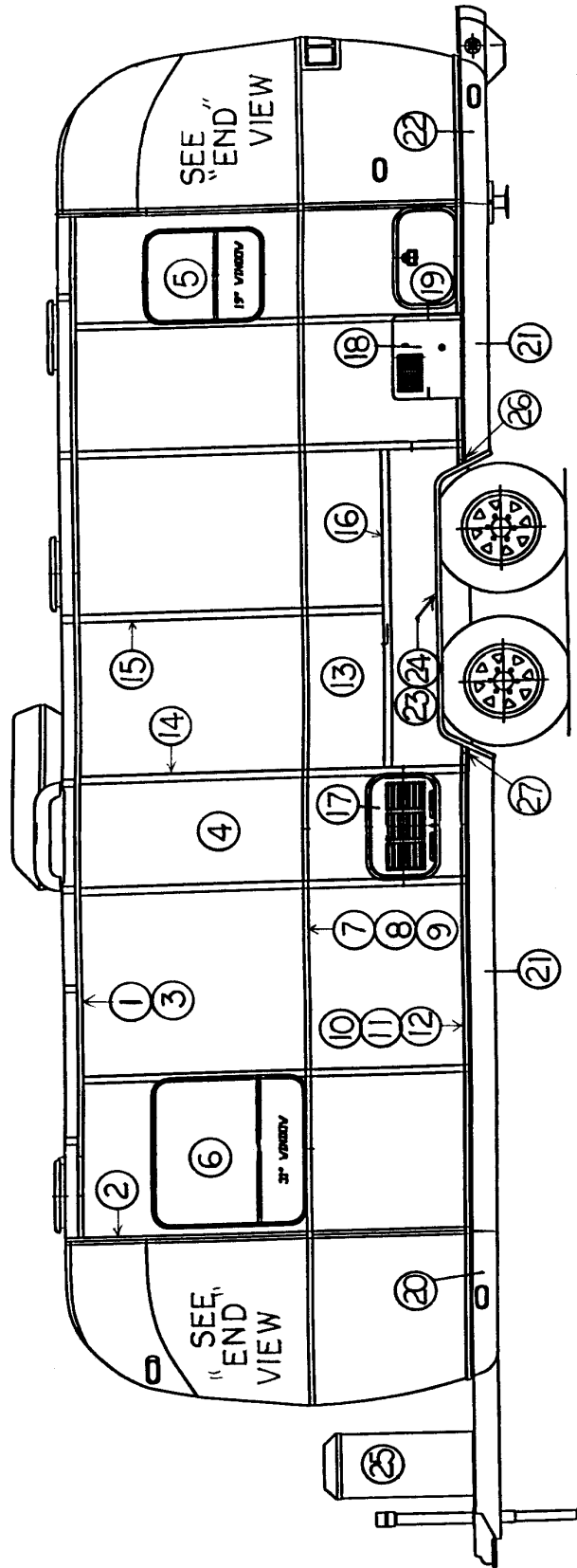

2000 SAFARI

BODY-27FT SAFARI, RS

(Hardware such as hinges, locks and latches are located in the **hardware** section of this book)

- | | |
|-------------------------|---|
| 1) 114290 | Extrusion, awning/drip rail |
| 2) 114993 | Rib, end bow |
| 3) 104707-05 | Extrusion, "I" beam |
| 4) 114880-262 | Aluminum sheet, upper, .040 x 51 x 262" |
| 5) 371362-02 | Window, 19.25 x 22.75" |
| 6) 371362-08 | Window, 31.25 X 29.75" |
| 7) 114328 | Extrusion, belt line |
| 8) 201912 | Molding, chrome, belt line |
| 9) 100034 | "Z" bar, 48" |
| 10) 114460 | Extrusion, rub rail |
| 11) 201763-01 | Insert, rub rail, chrome, 1" |
| 12) 100986 | Floor channel |
| 13) 114879-262 | Aluminum sheet, lower, .040 x 33 x 262" |
| 14) 114387-01 | Bow, Z rib, RH |
| 15) 114387-02 | Bow, Z rib, LH |
| 16) 100986 | Wheel well stiffener (floor channel) |
| 17) 922243 | Door, refrigerator access |
| 18) 690209 | Access cover, Atwood |
| 19) 100679-01 | Access door w/jamb |
| 20) 200542 | Banana wrap, RS front |
| 21) 101131-01 | Underbelly wrap, .024 x 22.5, pewter |
| 22) 200544 | Banana wrap, RS rear |
| 23) 684936 | Wheel well trim, inner, tandem axle |
| 24) 684937 ² | Wheel well trim, outer, tandem axle |
| 25) 104264-01 | Cover, 30# LPG bottles w/o decal |
| 26) 114466-01 | Casting, rub rail end, wheel well, RH |
| 27) 114466-02 | Casting, rub rail end, wheel well, LH |

²Revised 7/21/2000

2000 SAFARI

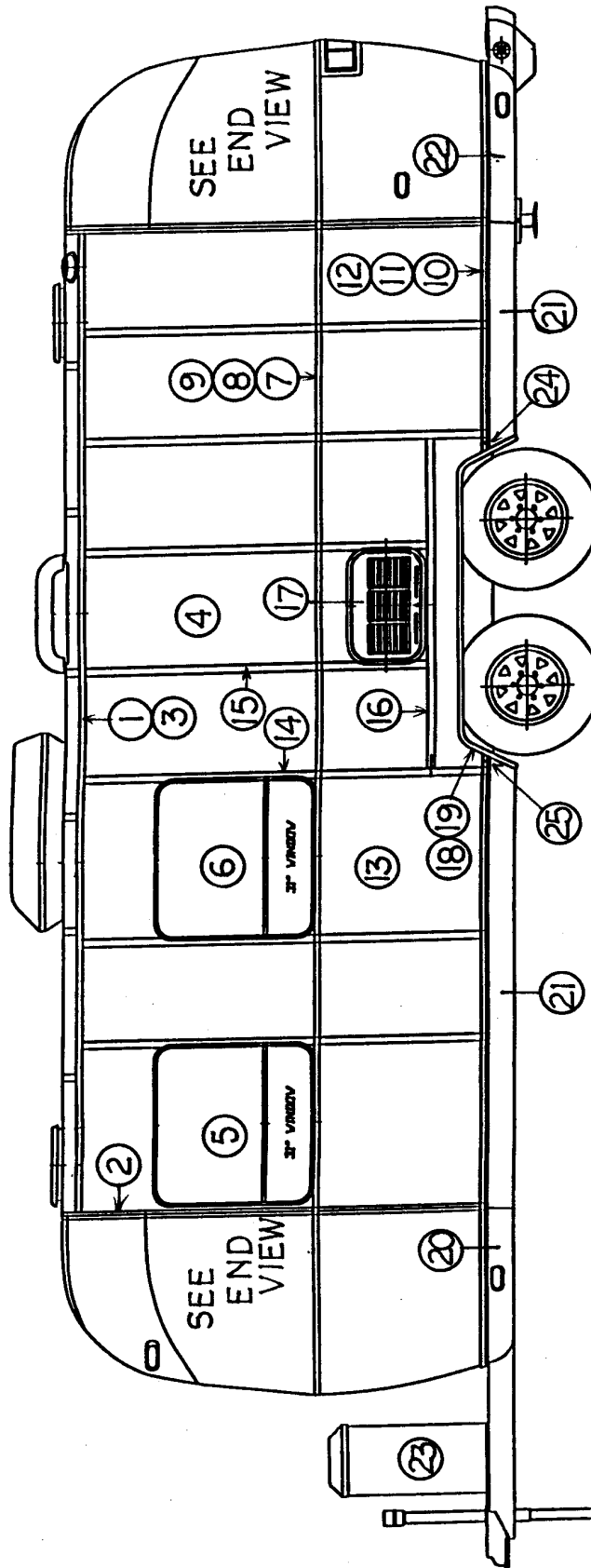

2000 SAFARI

BODY-25FT, SLEEP 6 SAFARI, RS

(Hardware such as hinges, locks and latches are located in the **hardware** section of this book)

- | | |
|----------------|---|
| 1) 114290 | Extrusion, awning/drip rail |
| 2) 114993 | Rib, end bow |
| 3) 104707-05 | Extrusion, "I" beam |
| 4) 114880-198 | Aluminum sheet, upper, .040 x 51 x 198" |
| 5) 371362-08 | Window, 31.25 x 29.75" |
| 6) 371362-08 | Window, 31.25 X 29.75" |
| 7) 114328 | Extrusion, belt line |
| 8) 201912 | Molding, chrome, belt line |
| 9) 100034 | "Z" bar, 48" |
| 10) 114460 | Extrusion, rub rail |
| 11) 201763-01 | Insert, rub rail, chrome, 1" |
| 12) 100986 | Floor channel |
| 13) 114879-198 | Aluminum sheet, lower, .040 x 33 x 198" |
| 14) 114387-01 | Bow, Z rib, RH |
| 15) 114387-02 | Bow, Z rib, LH |
| 16) 100986 | Wheel well stiffener (floor channel) |
| 17) 922243 | Door, refrigerator access |
| 18) 684936 | Wheel well trim, inner, tandem axle |
| 19) 684937 | Wheel well trim, outer, tandem axle |
| 20) 200542 | Banana wrap, RS front |
| 21) 101131-01 | Underbelly wrap, .024 x 22.5, pewter |
| 22) 200544 | Banana wrap, RS rear |
| 23) 104264-01 | Cover, 30# LPG bottles w/o decal |
| 24) 114466-01 | Casting, rub rail end, wheel well, RH |
| 25) 114466-02 | Casting, rub rail end, wheel well, LH |

2000 SAFARI

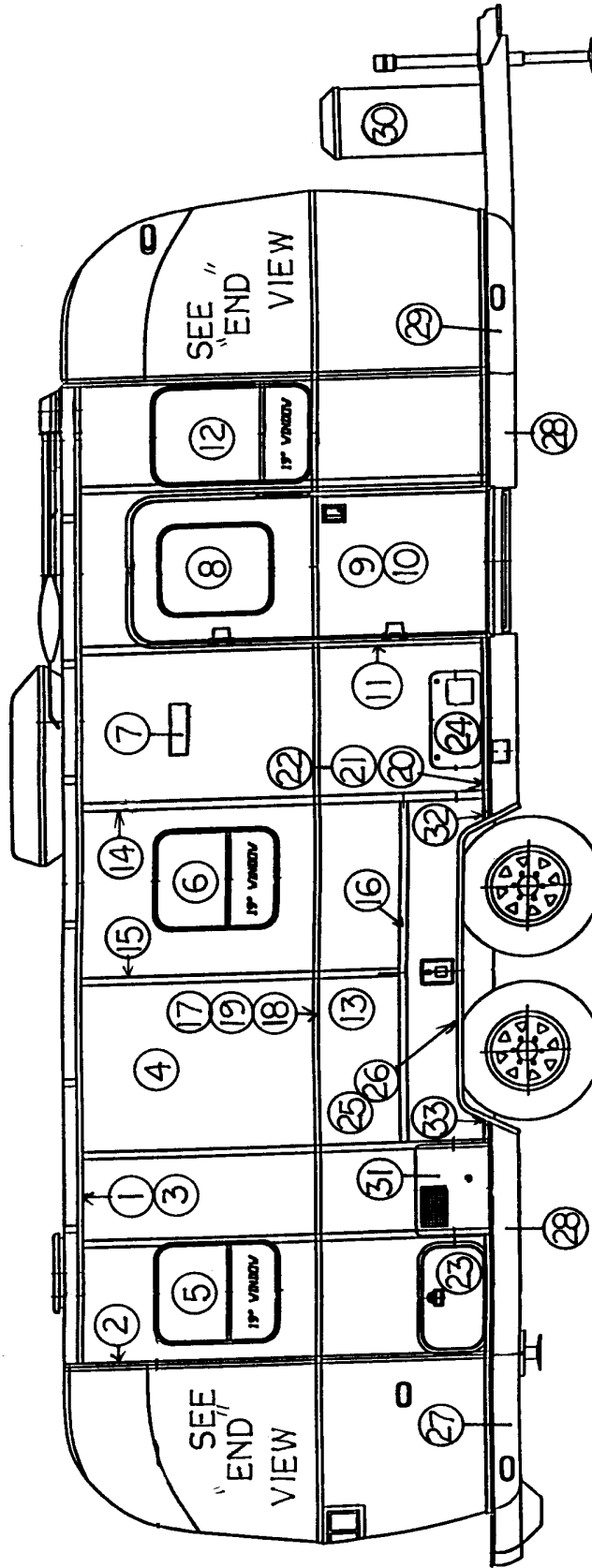

2000 SAFARI

BODY-25FT, SLEEP 6 SAFARI, CS

(Hardware such as hinges, locks and latches are located in the **hardware** section of this book)

- | | |
|----------------|---|
| 1) 114290 | Extrusion, awning/drip rail |
| 2) 114993 | Rib, end bow |
| 3) 104707-05 | Extrusion, "I" beam |
| 4) 114880-198 | Aluminum sheet, upper, .040" x 51" x 198" |
| 5) 371362-02 | Window, 19.25" x 22.75" |
| 6) 371362-02 | Window, 19.25" x 22.75" |
| 7) 511017-11 | Vent cover, range exhaust |
| 8) 371362-01 | Window, main door, 17.75" x 21.25" |
| 9) 110067-07 | Main door assembly |
| 10) 114654 | Screen door assembly |
| 11) 114652 | Jamb, main door |
| 12) 371362-07 | Window, 19.25" x 29.75" |
| 13) 114879-198 | Aluminum sheet, lower, .040" x 33" x 198" |
| 14) 114387-01 | Bow, Z rib, RH |
| 15) 114387-02 | Bow, Z rib, LH |
| 16) 100986 | Wheel well stiffener(floor channel) |
| 17) 114328 | Extrusion, belt line |
| 18) 201912 | Molding, chrome, belt line |
| 19) 100034 | "Z" bar, 48" |
| 20) 114460 | Extrusion, rub rail |
| 21) 201763-01 | Insert, rub rail, chrome, 1" |
| 22) 100986 | Floor channel |
| 23) 100679-01 | Access door w/jamb |
| 24) 690274-09 | Cover, Hydroflame furnace |
| 25) 684936 | Wheel well trim, inner, tandem axle |
| 26) 684937 | Wheel well trim, outer, tandem axle |
| 27) 200545 | Banana wrap, CS rear |
| 28) 101131-01 | Underbelly wrap, .024" x 22.5", pewter |
| 29) 200543 | Banana wrap, CS front |
| 30) 104264-01 | Cover, 30# LPG bottles w/o decal |
| 31) 690209 | Access cover, Atwood |
| 32) 114466-01 | Casting, rub rail end, wheel well, RH |
| 33) 114466-02 | Casting, rub rail end, wheel well, LH |

2000 SAFARI

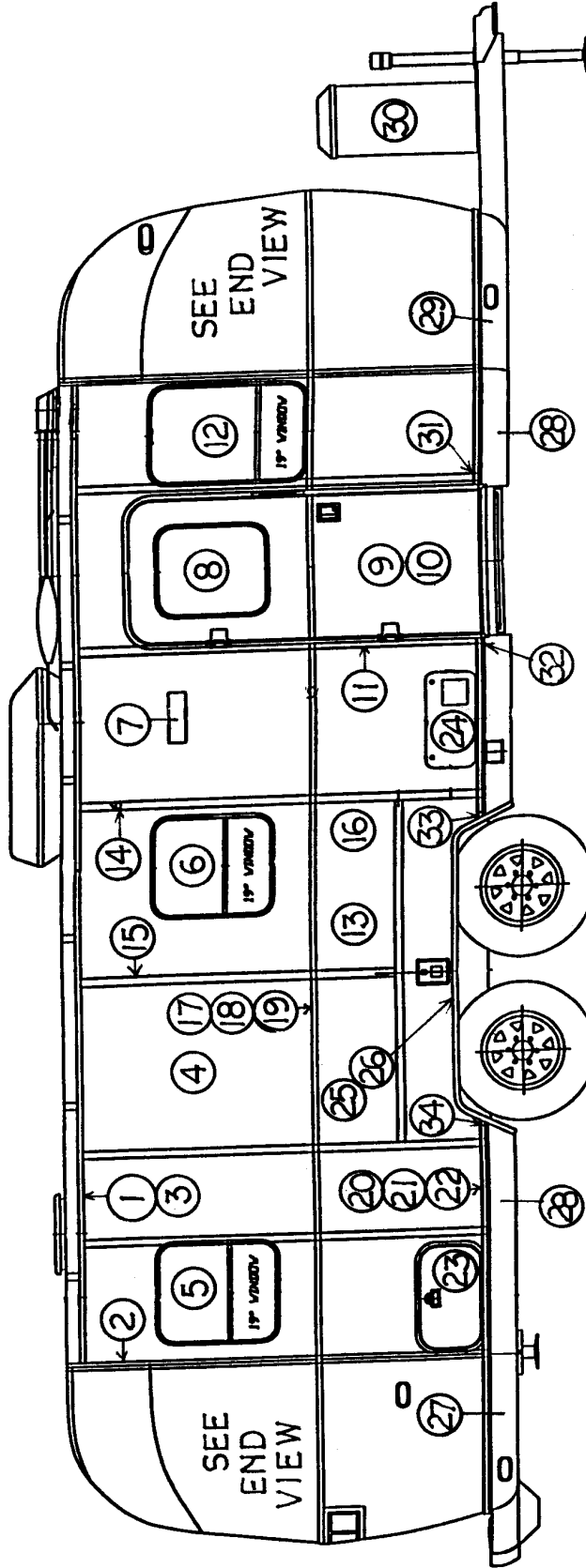

2000 SAFARI

BODY-25FT, SAFARI, CS

(Hardware such as hinges, locks and latches are located in the **hardware** section of this book)

- 1) 114290 Extrusion, awning/drip rail
- 2) 114993 Rib, end bow
- 3) 104707-05 Extrusion, "I" beam
- 4) 114880-198 Aluminum sheet, upper, .040 x 51 x 198"
- 5) 371362-02 Window, 19.25 x 22.75"
- 6) 371362-02 Window, 19.25 x 22.75"
- 7) 511017-11 Vent cover, range exhaust
- 8) 371362-01 Window, main door, 17.75 x 21.25"
- 9) 110067-07 Main door assembly
- 10) 114654 Screen door assembly
- 11) 114652 Jamb, main door
- 12) 371362-07 Window, 19.25 x 29.75"
- 13) 114879-198 Aluminum sheet, lower, .040 x 33 x 198"
- 14) 114387-01 Bow, Z rib, RH
- 15) 114387-02 Bow, Z rib, LH
- 16) 100986 Wheel well stiffener (floor channel)
- 17) 114328 Extrusion, belt line
- 18) 201912 Molding, chrome, belt line
- 19) 100034 "Z" bar, 48"
- 20) 114460 Extrusion, rub rail
- 21) 201763-01 Insert, rub rail, chrome, 1"
- 22) 100986 Floor channel
- 23) 100679-01 Access door w/jamb
- 24) 690274-09 Cover, Hydroflame furnace
- 25) 684936 Wheel well trim, inner, tandem axle
- 26) 684937 Wheel well trim, outer, tandem axle
- 27) 200545 Banana wrap, CS rear
- 28) 101131-01 Underbelly wrap, .024 x 22.5, pewter
- 29) 200543 Banana wrap, CS front
- 30) 104264-01 Cover, 30# LPG bottles w/o decal
- 31) 114465-01 Casting, rub rail end, door, RH
- 32) 114465-02 Casting rub rail end, door, LH
- 33) 114466-01 Casting, rub rail end, wheel well, RH
- 34) 114466-02 Casting rub rail end, wheel well, LH

2000 SAFARI

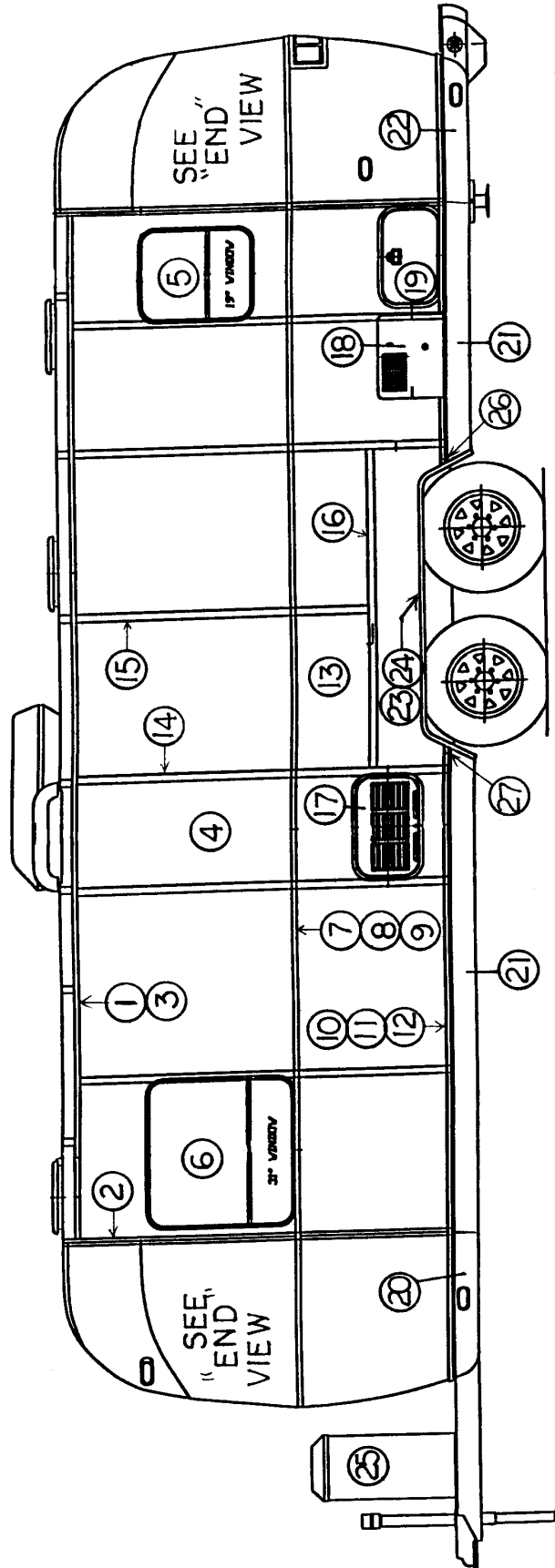

2000 SAFARI

BODY-25FT SAFARI, RS

(Hardware such as hinges, locks and latches are located in the **hardware** section of this book)

- | | |
|----------------|---|
| 1) 114290 | Extrusion, awning/drip rail |
| 2) 114993 | Rib, end bow |
| 3) 104707-05 | Extrusion, "I" beam |
| 4) 114880-198 | Aluminum sheet, upper, .040 x 51 x 198" |
| 5) 371362-02 | Window, 19.25 x 22.75" |
| 6) 371362-08 | Window, 31.25 X 29.75" |
| 7) 114328 | Extrusion, belt line |
| 8) 201912 | Molding, chrome, belt line |
| 9) 100034 | "Z" bar, 48" |
| 10) 114460 | Extrusion, rub rail |
| 11) 201763-01 | Insert, rub rail, chrome, 1" |
| 12) 100986 | Floor channel |
| 13) 114879-198 | Aluminum sheet, lower, .040 x 33 x 198" |
| 14) 114387-01 | Bow, Z rib, RH |
| 15) 114387-02 | Bow, Z rib, LH |
| 16) 100986 | Wheel well stiffener (floor channel) |
| 17) 922243 | Door, refrigerator access |
| 18) 690209 | Access door, Atwood |
| 19) 100679 | Access door w/jamb |
| 20) 200542 | Banana wrap, RS front |
| 21) 101131-01 | Underbelly wrap, .024 x 22.5, pewter |
| 22) 200544 | Banana wrap, RS rear |
| 23) 684936 | Wheel well trim, inner, tandem axle |
| 24) 684937 | Wheel well trim, outer, tandem axle |
| 25) 104264-01 | Cover, 30# LPG bottles w/o decal |
| 26) 114466-01 | Casting, rub rail end, wheel well, RH |
| 27) 114466-02 | Casting, rub rail end, wheel well, LH |

2000 SAFARI

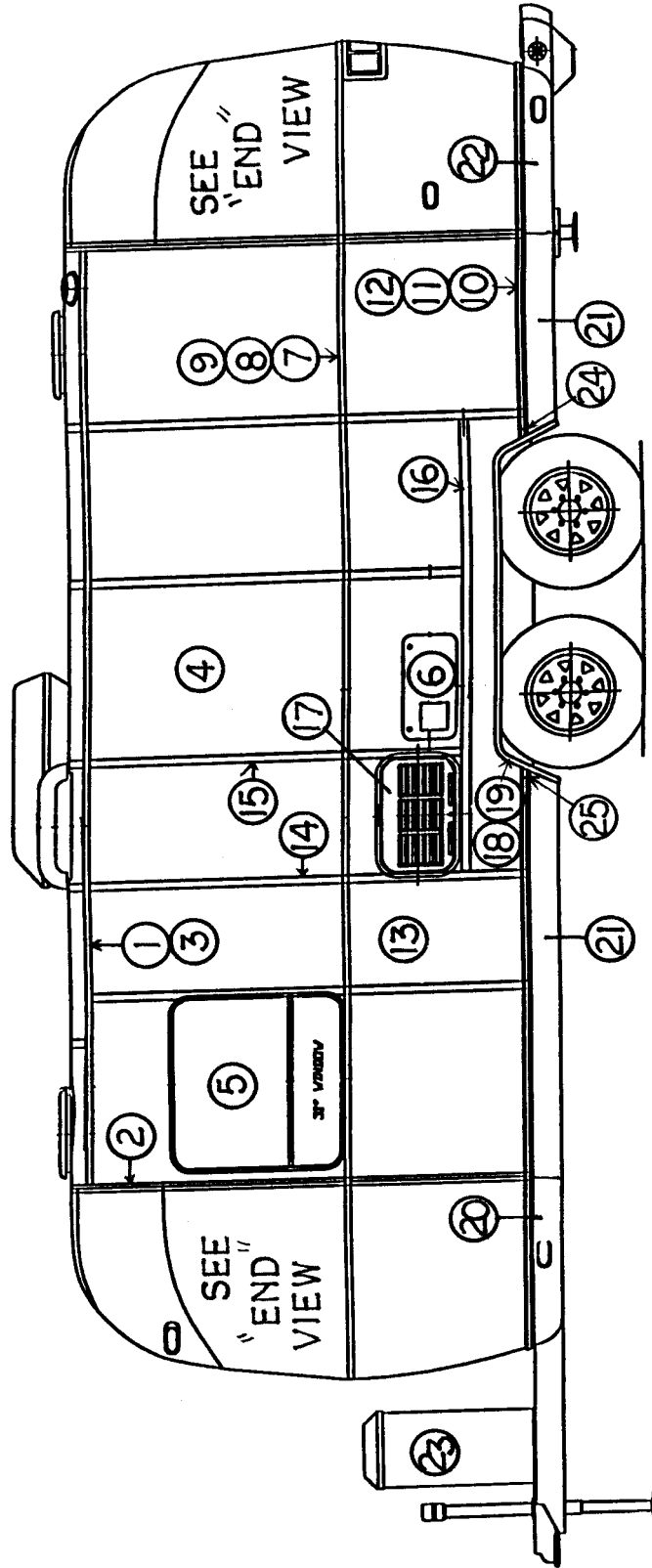

2000 SAFARI

BODY-23FT, SAFARI, RS

(Hardware such as hinges, locks and latches are located in the **hardware** section of this book)

- | | |
|----------------|---|
| 1) 114290 | Extrusion, awning/drip rail |
| 2) 114993 | Rib, end bow |
| 3) 104707-05 | Extrusion, "I" beam |
| 4) 114880-198 | Aluminum sheet, upper, .040 x 51 x 198" |
| 5) 371362-08 | Window, 31.25 x 29.75" |
| 6) 690274-09 | Cover, Hydroflame furnace |
| 7) 114328 | Extrusion, belt line |
| 8) 201912 | Molding, chrome, belt line |
| 9) 100034 | "Z" bar, 48" |
| 10) 114460 | Extrusion, rub rail |
| 11) 201763-01 | Insert, rub rail, chrome, 1" |
| 12) 100986 | Floor channel |
| 13) 114879-198 | Aluminum sheet, lower, .040 x 33 x 198" |
| 14) 114387-01 | Bow, Z rib, RH |
| 15) 114387-02 | Bow, Z rib, LH |
| 16) 100986 | Wheel well stiffener (floor channel) |
| 17) 922243 | Door, refrigerator access |
| 18) 684936 | Wheel well trim, inner, tandem axle |
| 19) 684937 | Wheel well trim, outer, tandem axle |
| 20) 200542 | Banana wrap, RS front |
| 21) 101131-01 | Underbelly wrap, .024 x 22.5, pewter |
| 22) 200544 | Banana wrap, RS rear |
| 23) 104264-01 | Cover, 30# LPG bottles w/o decal |
| 24) 114466-01 | Casting, rub rail end, wheel well, RH |
| 25) 114466-02 | Casting, rub rail end, wheel well, LH |

2000 SAFARI

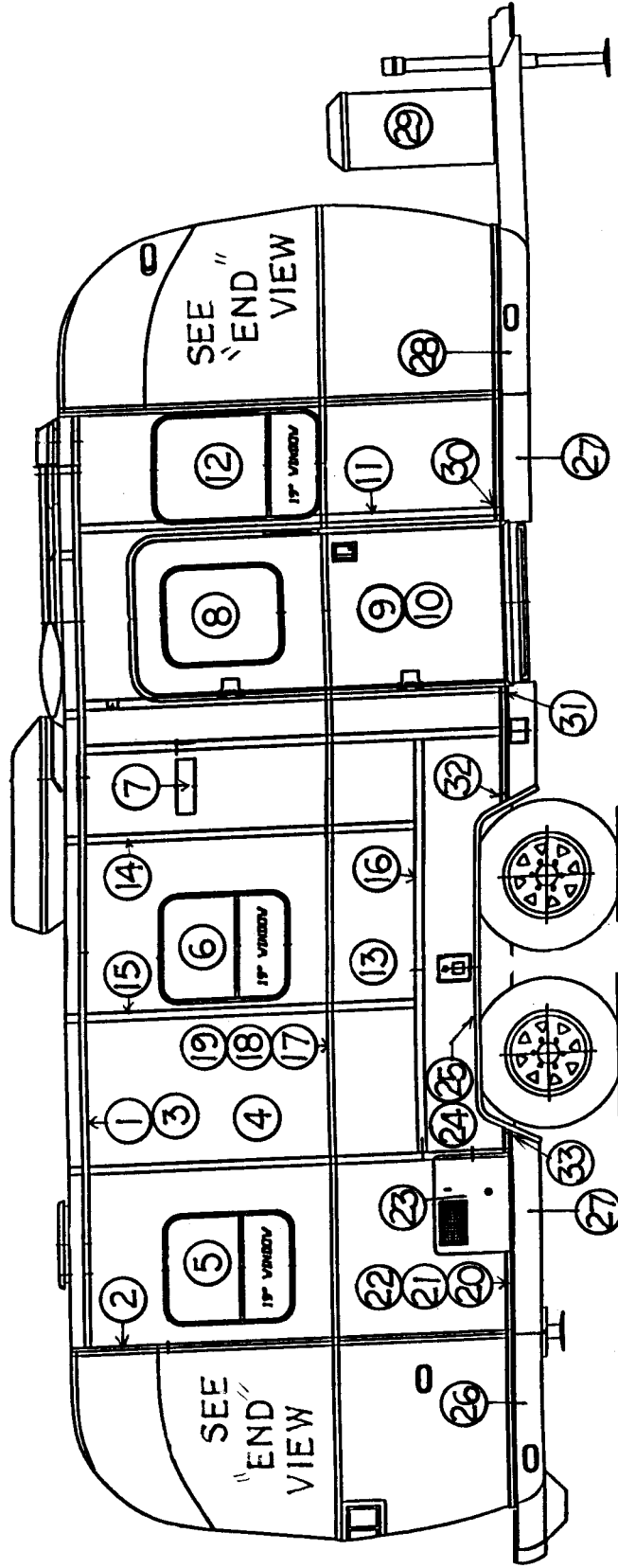

2000 SAFARI

BODY-23FT, SAFARI, CS

(Hardware such as hinges, locks and latches are located in the **hardware** section of this book)

- 1) 114290 Extrusion, awning/drip rail
- 2) 114993 Rib, end bow
- 3) 104707-05 Extrusion, "I" beam
- 4) 114880-198 Aluminum sheet, upper, .040 x 51 x 198"
- 5) 371362-02 Window, 19.25 x 22.75"
- 6) 371362-02 Window, 19.25 x 22.75"
- 7) 511017-11 Vent cover, range exhaust
- 8) 371362-01 Window, main door, 17.75 x 21.25"
- 9) 110067-01 Main door assembly
- 10) 114654 Screen door assembly
- 11) 114652 Jamb, main door
- 12) 371362-07 Window, 19.25 x 29.75"
- 13) 114879-198 Aluminum sheet, lower, .040 x 33 x 198"
- 14) 114387-01 Bow, Z rib, RH
- 15) 114387-02 Bow, Z rib, LH
- 16) 100986 Wheel well stiffener (floor channel)
- 17) 114328 Extrusion, belt line
- 18) 201912 Molding, chrome, belt line
- 19) 100034 "Z" bar, 48"
- 20) 114460 Extrusion, rub rail
- 21) 201763-01 Insert, rub rail, chrome, 1"
- 22) 100986 Floor channel
- 23) 69020 Access cover, Atwood
- 24) 684936 Wheel well trim, inner, tandem axle
- 25) 684937 Wheel well trim, outer, tandem axle
- 26) 200545 Banana wrap, CS rear
- 27) 101131-01 Underbelly wrap, .024 x 22.5, pewter
- 28) 200543 Banana wrap, CS front
- 29) 104264-01 Cover, 30# LPG bottles w/o decal
- 30) 114465-01 Casting, rib rail end, door, RH
- 31) 114465-02 Casting, rub rail end, door, LH
- 32) 114466-01 Casting, rub rail end, wheel well, RH
- 33) 114466-02 Casting, rub rail end, wheel well, LH

2000 SAFARI

BODY INTERIOR

964137-02	Roof locker & aft end liner, 25 & 27ft.-A&B
964523	Roof locker & aft end liner, 23 & 25ft.-"C"
964137-01	Roof locker & forward end liner, all Safari
114445	Aluminum sheet, .032 x 34" x coil
114853-01	Aluminum sheet, .032 x 57" x coil
702482-03*	Head liner, Spectra Opal
702481*	Wall liner, Geometric Pearl
114157-01	Extrusion, end liner, upper, white
201728-01	Extrusion, ceiling trim retainer
201728-03	Extrusion, ceiling trim
203225	Trim, flexible, "U", white
203138-01	Extrusion, plastic, wall, white
203138-02	Extrusion, plastic, wall, brown
101077	Extrusion, main doorjamb trim, interior
110460-01	Trim ring, window, 17.75" x 21.25"
110460-02	Trim ring, window, 19.25" x 22.75"
110460-06	Trim ring, window, 19.25" x 29.75"
110460-07	Trim ring, window, 31.25" x 29.75"
110460-05	Trim ring, window, 49.63" x 24.19"
110521	Trim ring, window, rear egress, 23&25ft."C"
200514	Wheel well insulator, tandem

*For repairs purchase vinyl glues locally.

2000 SAFARI

CHASSIS

7350475H	Axle, 3, 500#-27ft.
7300253	Axle, 3, 000#-23&25ft.
0220003	Shock absorber
0250173-15	Bolt, grade 5-- 5/8-18x1.5", shock mount
0130068-818	Nut, hex head flanged, 5/8-18, shock mount
410834	Tire and wheel assembly, 15", BSW
410834-100	Wheel, aluminum, 15x6, Safari/Bambi
400844	Dust cover, center hub
400923	Acorn lug nut
200844	Wheel well, tandem
3320028	Jack, front, Atwood
453570	Stabilizer plate, front jack
410598	Foot pad
381416	Step, single, Elkhart#124
410831	Rear bumper, Safari
453497	Lid, rear hose carrier
453538	Bottom, rear hose carrier
380024	Support arm, hose carrier lid
380067	Hose carrier lid latch (Cam-o-lock)
381435	Hatch, access cover, 4", white (power cord)
400914-01	Stabilizer jack, rear
400914-02	Handle, rear stabilizer jack

(continued)

2000 SAFARI CHASSIS

0300027	Break away switch, Bargman
0360254H	Bracket, breakaway switch
601642	Pan, tank support, Roto cast
453493	Hanger strap, tank pan
114679	Aluminum underbelly, .019x65.75xcoil
101131-0	Aluminum, underbelly wrap, .024 x22.5, gray

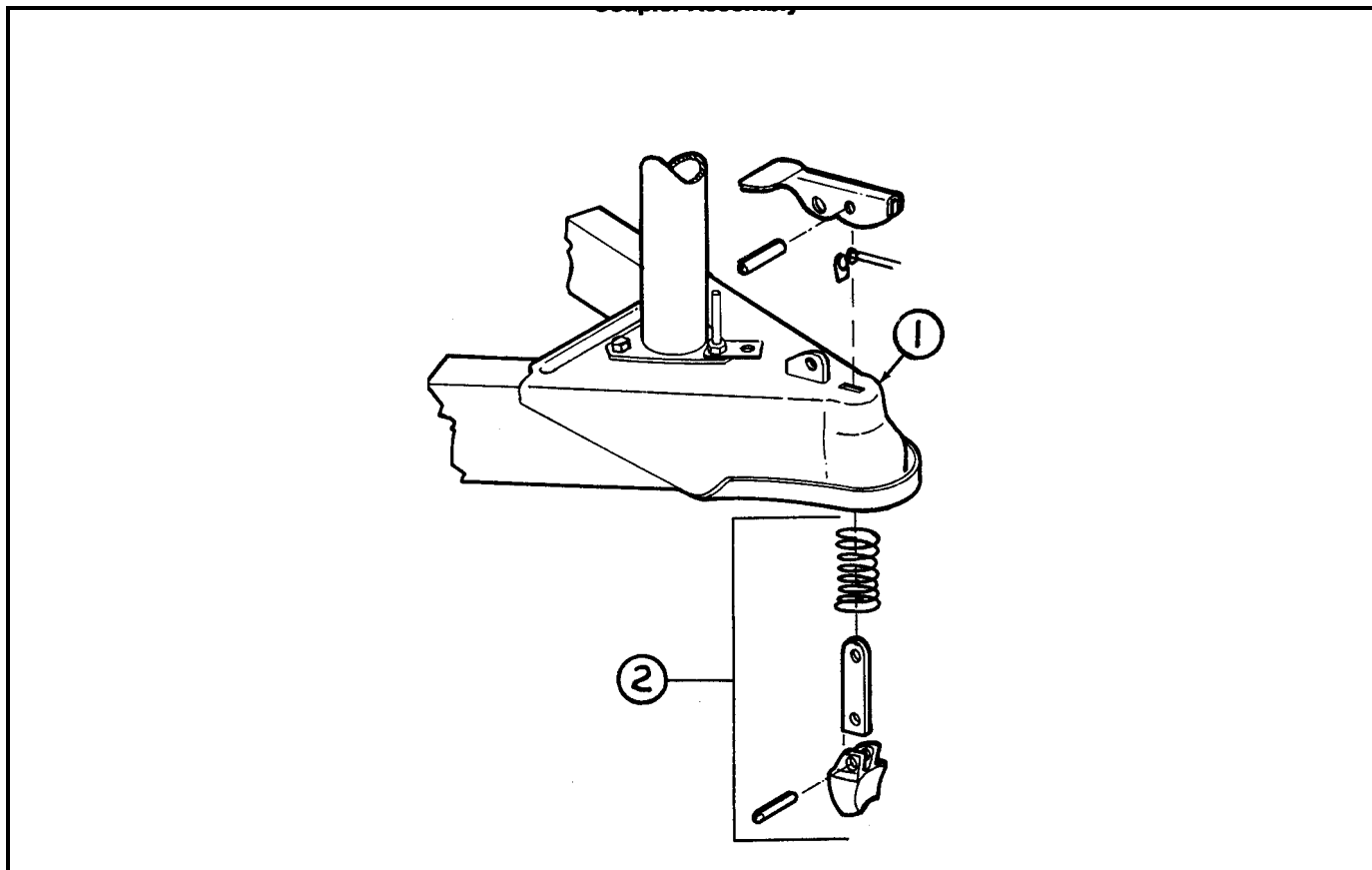

1) 680343	Coupler assembly, 2 5/16"
2) 680345	Repair kit, 2 5/16" coupler

(continued)

2000 SAFARI

CHASSIS

12" BRAKES

3160121 Brake drum, 12", 6 lug
450659 Inner bearing, #25580
680364 Inner race, #25520
450658 Outer bearing, #LM67048
680365 Outer race, #LM67010
680370-100 Grease seal

3160347 Brake assembly, RH, 12" Dexter
3160348 Brake assembly, LH, 12" Dexter

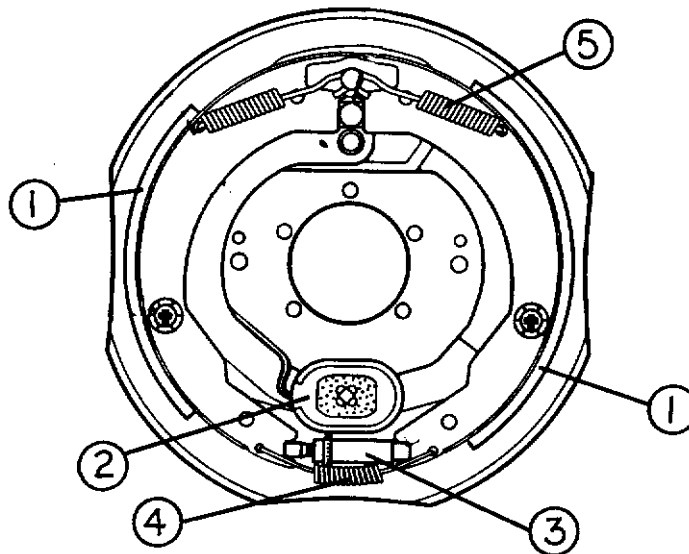

1) 3160348-62 Shoe and lining kit (includes hold down spring and pin)
2) 3160348-65 Magnet kit
3) 3160348-63 Adjuster assembly
4) 3160348-64 Adjusting screw spring
5) 3160348-61 Retractor spring

2000 SAFARI

SECTION II

D through E

DECALS/EXTERIOR TRIM..... II-1

DOORS/WINDOWS/AWNING

Doors..... II-2

Windows..... II-3

Awning..... II-3

DRAPES/BLINDS/VALANCES II-4

ELECTRICAL

110 volt..... II-5

12 volt II-6

ENTERTAINMENT

Radio/antenna..... II-8

2000 SAFARI

DECALS/EXTERIOR TRIM

386050-01	Decal stripe, side, Safari/Bambi
386051	Decal, "AIRSTREAM" 32", front and rear
386054	Decal, logo, "SAFARI", sides
386043-02	Medallion, oval, blue, "AIRSTREAM"
386067	Medallion, 70th anniversary, 4.375"
386068	Medallion, screen door, 3", black
114460	Extrusion, rub rail, 16'
201763-01	Insert, rub rail, chrome, 1"
114466-01	Close out, casting, rub rail, angled RH
114466-02	Close out, casting, rub rail, angled LH
114465-01	Close out, casting, rub rail RH
114465-02	Close out, casting, rub rail LH
114328	Extrusion, beltline
201912	Molding, chrome, beltline insert

2000 SAFARI

DOORS/WINDOWS/AWNING

(Hardware such as hinges, locks and latches are located in the **hardware** section of this book.)

DOORS

115207-01	Main door assembly
114652	Jamb, main door, preformed
114653	Frame, main door, preformed
114448-02	Skin, exterior, upper main door
114449-02	Skin, exterior, lower main door
114475	Skin, inner, vinyl clad
114363	Drip cap, main door
365232	Seal, main door
114654	Screen door assembly
114561	Panel, slider, screen door
203000-01	Close out, plastic, screen door
203287-02	Close out, plastic, screen door w/dead bolt
380079	Screen, gray
200518	Spline, gray, screen insert
365013	Gasket, screen door, foam tape
922243	Door, refrigerator access
104417	Jamb, refrigerator access door
104439	Louvered panel, refrigerator access door
203225	Trim, flexible
100679-01	Side access door assembly
365035	Seal, side access door
921159-01	Trunk door assembly, rear, 27 twin
365035	Seal, access door

(continued)

2000 SAFARI

DOORS/WINDOWS/AWNINGS

(Hardware such as hinges, locks and latches are located in the **hardware** section of this book.)

WINDOWS

371362-01	Window, 17.75" x 21.25"
371362-02	Window, 19.25" x 22.75"
371362-07	Window, 19.25" x 29.75"
371362-08	Window, 31.25" x 29.75"
371362-06	Window, 49.63" x 24.19", egress rear (ends#513214
371362-12	Window, 49.63" x 24.19", egress rear (start #513215
371362-09	Window, 49.63" x 24.19", split egress, 23&25 "C"
371362-05	Window, 49.63" x 24.19", front

AWNINGS

110102-01	Rock guard
685351	Rubber frame, black
683960	Arm support
683959	Arm support bracket
685354	Front window key
702993-02	Awning, patio, 14' 4 1/2", 23ft.
702993-01	Awning, patio, 16' 4 1/2", 25ft.
702993-03	Awning, patio, 18' 4 1/2", 27ft.
702993	Hardware package, Zip Dee

2000 SAFARI

DRAPES/BLINDS/VALANCES

- 110525 Curtain set-23ft.
- 110485 Curtain set-25ft.
- 110505 Curtain set-25ft. sleep six
- 110552 Curtain set-27ft.

702355-01 Shade, roller type, 20 1/8 x 36" galley

- 964104-25S Valance, lounge, RS 64"
- 964105-25S Valance, lounge, CS 35"
- 964106-25S Valance, rear twin 43" (both sides)



101220
Bracket, curtain
stand off



114021
Bracket, curtain
stand off



101217
Track, curtain



101225
Bracket, curtain
stand off

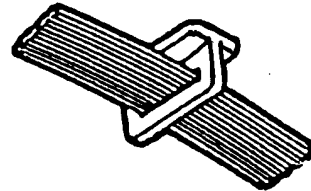

700044
Glides, w/elastic
"T" type

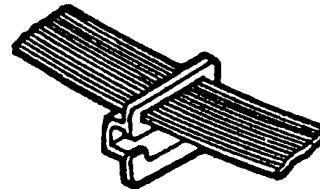

700045
Glides, w/elastic
"G" type

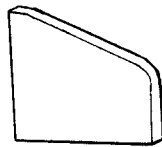

200785
End, curtain track, LH

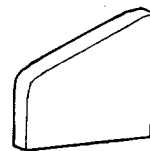

200784
End, curtain track, RH

2000 SAFARI

ELECTRICAL

110 VOLT

510634	Power cord, 36ft.
511041	Breaker box, Westinghouse
510564-05	Breaker 30-20, Bryant
510564-04	Breaker 20-20, Bryant
510564-20	Breaker, 20 GFI
510564-07	Breaker 15 GFI, Bryant
500563-01	Receptacle, 15 amp, white
511287	Receptacle, 15 amp, single
510676-01	Outlet, exterior, gray
511023	Circuit tester (loose item)
511426	Converter, 55 amp

2000 SAFARI

ELECTRICAL

12 VOLT

511132	Battery, deep cycle, lead acid
511386	Battery box
340023	Latch, Corbin, battery box
453603	Strap, battery box
500886	7-Way cable w/plug
0300027	Break away switch, Bargman
511426	Converter, 55 amp
510626	Switch, master disconnect
510627	Face plate, disconnect switch
511337	Fuse block, 12 volt, 6 position-ATC type
511248	Light, 12 volt, incandescent, single, interior
511249	Light, 12 volt, incandescent, double, interior
510781	Detector, smoke
511309	Detector, LPG
511341-02	Monitor panel, wall mount
502056	Mounting plate, 12 volt switch
511327	Switch body w/rocker, single, white
510868-03	Switch panel, 4 gang, white, by door
511100-01	Switch body w/rocker, white
511077-03	Cover, switch, white w/gold print
510807	Outlet, 12 volt
511121	Mounting plate, 12 volt receptacle

(continued)

2000 SAFARI

ELECTRICAL

12 VOLT

500996	Jack, TV/phone, gray
510654-01	TV jack/12 volt w/splitter, white
510624-01	Modular phone quick jack, white
104619	Mounting plate, exterior telephone/TV jack

EXTERIOR LIGHTS/REFLECTORS

510732	Utility light (by door)
500500	Tail light assembly
510161	Can, #1156 bulb and socket
510160	Can, #1157 bulb and socket
510162	Tail light lens
510163	Back-up light lens
380226	Gasket, tail light lens
201462	Pocket , plastic, taillight
109172	Bezel, chrome, tail light
510111	Clearance light, red, Signal Stat
510112	Clearance light, amber, Signal Stat
500095	Reflector, red, rectangular
500096	Reflector, amber, rectangular
510446	Reflector, red, stick-on w/chrome edge
500053	License plate light w/plate mounting bracket
511294	Light, license plate
510658	Switch w/weather proof boot

2000 SAFARI

ENTERTAINMENT

511498	Radio, AM/FM/Cassette, Sony XR-1790
511048	Speaker, 40 Watt, Coustic HS-402
511499	CD changer, 10unit, Sony CDX-424RF (opt.)
510610	Antenna, radio, side mount
510788-01	TV antenna, Winegard #RV-7004
510788-03	Amplifier, TV antenna
510612	Coax, 75 ohm, standard
510613	Coax, 75-ohm w/three conductors
510623	Connector, coax, male to male
114396	Trough, TV antenna

2000 SAFARI

SECTION III

F through H

FASTENERS (common fasteners available locally are not listed)

Rivets III-1

FLOOR COVERING

Carpet..... III-3

Mats III-3

FURNITURE

Interior doors III-4

Mirrors III-5

Drawer III-5

Rear bedroom III-6

Bath III-7

Galley III-10

Lounge..... III-14

HARDWARE

Exterior locks/hinges III-17

Interior drawer slides/hinges latches..... III-21

Bath accessories III-24

Awning hardware III-26

2000 SAFARI

*FASTENERS



325043
Rivet, buck type
dia. 1/8"
length 1/4"
(hard)



325000-01
Rivet, buck type
dia. 1/8"
length 1/4"
anodized clear



325000-03
Rivet, buck type
dia. 1/8"
length 1/4"
anodized white



325001-01
Rivet, buck type
dia. 1/8"
length 5/16"
anodized clear



325002-01
Rivet, buck type
dia. 1/8"
length 3/8"
anodized clear



325004-01
Rivet, buck type
dia. 1/8"
length 1/2"
anodized clear

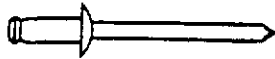

330127-03
dia. 1/8"
grip range .063-.125
aluminum body
aluminum mandrel



300101
1/8" I.D.
washer, aluminum

*Common bolts and screws readily available at local hardware outlets have not been listed.

2000 SAFARI

*FASTENERS

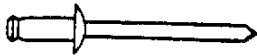

330126-02
rivet, pop
dia. 1/8
grip range .126-.187
stainless steel body
stainless steel mandrel

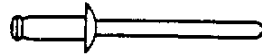

330126-03
rivet, pop
"dia. 1/8 "
grip range .126-.250
stainless steel body
stainless steel mandrel

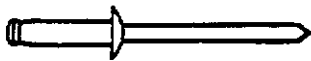

330127-050
rivet, pop
dia.1/8"
grip range .251-.312
aluminum body
aluminum mandrel

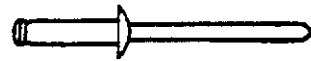

330128-05
rivet, pop
dia. 1/8"
grip range .251-.312
aluminum body, white
aluminum mandrel

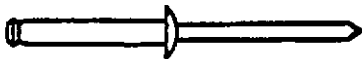

330127-080
rivet, pop
dia.1/8"
grip range .325-.565
aluminum body
aluminum mandrel

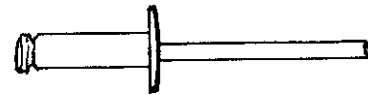

330038
rivet, pop
dia..150 (#20 bit)
grip range .126-.250
aluminum body
aluminum mandrel
(used-screen door hinge)

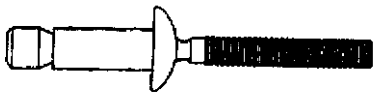

325103
dia. 1/4"
grip range .080-.325
SS body
steel mandrel

*Common bolts and
screws not listed.

2000 SAFARI FLOOR COVERING

702794-01	Carpet, Spectrum, Pike Green
701538	Carpet, Velour-compartment liner
700173	Pad, carpet, 3/8" thick
381346	Floor mats
703037	Flooring, laminate, bath, Capisto Sand, 15.5x15.5
801291	Trim, laminate flooring, Capisto Sand

2000 SAFARI
FURNITURE
WARDROBE/CABINET DOORS

		Width x height (inches)
964385-25	Door	8.75 x 38.0"
964385-14	Door	8.75 x 62.0"
964385-17	Door	9.13 x 24.0"
964385-26	Door	12.0x 38.0"
964385-27	Door	13.19 x 31.25"
964385-18	Door	13.25 x 62.0"
964385-12	Door	13.63 x 38.0"
964385-10	Door	14.00 x 21.0"
964385-02	Door	14.25 x 31.25"
964385-21	Door	15.63 x 11.88"
964385-20	Door	15.75 x 13.75"
964385-23	Door	17.38 x 22.0"
964385-06	Door	17.75 x 13.75"
964385-01	Door	18.63 x 31.25"
964385-09	Door	18.75 x 8.5"
964385-22	Door	21.00 x 62.0"
964385-15	Door	22.25 x 62.0"
964385-04	Door	23.00 x 8.00"
964385-19	Door	24.88 x 10.5"
964385-24	Door	25.13 x 15.25"
964385-13	Door	25.13 x 17.50"
964385-07	Door	32.50 x 13.75
964385-08	Door	45.00 x 13.75
964385-16	Door, breaker box cover	7.5 x 13.75"

**2000 SAFARI
FURNITURE
ROOF LOCKER DOORS**

964386-01	Door, roof locker, front and rear-RH&LH, 31.25
964386-02	Face panel, locker end filler, spec. RH or LH
964386-06	Door, roof locker, 32.5"
964386-04	Face panel, 6.19", rear locker, "C" model
964386-03	Door, galley roof locker, 28.38"
964386-05	Door, galley roof locker, 35.5"

MISCELLANEOUS DOORS

702937-03	Shower door, roll away 36" x 62"
961413-16	Door slider assembly, 20.5" x 74"
964539	Bath door assembly, 25.5" x 72", "C" model
986265	Sliding door assembly, 25ft., "A&B" model
372203-04	Mirror, safety glass, medicine cabinet, 36" x 14
372203-05	Mirror, safety glass, medicine cabinet, 19" x 14
372203-24	Mirror, safety glass 9.5" x 20.0
702681-04	Door, foldette, 56" x 73"
702681-03	Door, foldette, 46" x 73"
381563-01	Track, formed, foldette door
701342-01	Strap, foldette door retainer

DRAWERS/DRAWER BOX

201016	Drawer, plastic, 16" x 22"
201051	Drawer, plastic, 10" x 22"
964906-03	Drawer box 2.75" x 14.0" x 11.50"
964906-06	Drawer box 2.75" x 12.0" x 18.00"
962821-27	Drawer box 5.00" x 18.0" x 17.50"

2000 SAFARI FURNITURE

REAR BEDROOM, TWIN-25&27FT.

964113	Night stand assembly
964337	Top, twin nightstand
964173	Twin bed assembly, CS
964114-01	Twin bed assembly, RS
964115-01	Hanging wardrobe assembly, RS
964155	Hanging linen closet, CS

REAR BEDROOM, DOUBLE-25 & 27FT.

964188	Double bed assembly, "B" model
964115-01	Hanging wardrobe. RS
964184	Nightstand
963336	Top, rear nightstand, rear double
381241	TV shelf

REAR BEDROOM, CORNER DOUBLE-23 & 25S

108433	Header, foldette door
200003	End cap mounting, brown
381563-01	Track, formed, foldette door
964252	Bed assembly, corner double, Safari
964397	Wardrobe assembly, RS 23ft.
964250	Wardrobe assembly, RS 25ft.
381241	TV shelf

2000 SAFARI

FURNITURE

BATHROOM, CORNER DOUBLE-23 & 25S
(see hardware section for fixtures-if connected
to water, see plumbing)

203114	Shower, two piece fiberglass
203138-01	Plastic wall extrusion, white
964325	Toilet stand assembly
964249	Lavatory cabinet
964315	Lavatory top
964319	Medicine cabinet, lower
964318	Medicine cabinet, upper
964312	Header, bath door
104606	Close-out, vent pipe
702791	Border trim, self-adhesive, bathroom

2000 SAFARI

FURNITURE

BATHROOM 25FT. A & B MODELS

(See hardware section for fixtures. If connected to water, see plumbing)

201980	Shower stall, two-piece, fiberglass
964226	Shower stand assembly
964132	Toilet stand assembly
801195	Corner, trim-1" radius
964618	Jamb, shower door
964130-01	Lavatory cabinet assembly
964340	Lavatory top
200963-01	Track, lavy sliding door, upper
200963-02	Track, lavy sliding door, lower
104606	Close out, alabaster, vent pipe
114040-0	Close out, toilet line
381611	Cosmetic cabinet 36" x 9"
964129	Medicine cabinet
702791	Border, adhesive back, above lavy

2000 SAFARI

FURNITURE

BATHROOM, 27FT. A&B MODELS

(See hardware section for fixtures. If connected to water, see plumbing)

203046-03 964993	Shower stall, angled, two piece Close out, lavy/shower
964473 964491	Lavatory cabinet assembly Lavatory top assembly
200963-01 200963-02	Track, lavy sliding door, upper Track, lavy sliding door, lower
381611 964729	Cosmetic cabinet, 36" x 9" Medicine cabinet assembly
702791	Border trim, self adhesive, above bath cabinet
104606 114040-01 800727-01	Close out, vent pipe, Alabaster Close out, toilet line Close out, foldette door, oak
964466	Wardrobe assembly CS-27ft.

2000 SAFARI FURNITURE

GALLEY AREA, 23FT.

964523-01	Galley assembly
964524-01	Galley top assembly
964335	Galley flip-up shelf
963990	Magazine rack
964980-01	Sink cover
964151	Galley roof locker assembly
964251	Refrigerator cabinet assembly
964532	Spice rack
372203-05	Mirror, safety glass 19" x 14"
964396	Pantry cabinet assembly
381400	Drawer slide, pantry, 14", pr.
964162	Pantry assembly

2000 SAFARI FURNITURE

GALLEY AREA, 25FT. "C"

964523-01	Galley assembly
964524-01	Galley top assembly
964335	Galley flip-up shelf
963990	Magazine rack
964980-01	Sink cover
964151	Galley roof locker assembly
964251-01	Refrigerator cabinet assembly
964532	Spice rack
372203-05	Mirror, safety glass 19" x 14"
964359	Dinette seat assembly, aft.
801224-02	Cap, dinette seat back, aft.
964256	Dinette seat assembly, forward
801224-01	Cap, dinette seat back, forward
964255	Dinette table assembly, Safari
962177-02	Leg, dinette table, hardwood, 28.5"
964254	Dinette roof locker assembly
964116	Pantry/wardrobe assembly
964162	Pantry assembly
381400	Slides, 14", pantry, pr.

2000 SAFARI FURNITURE

GALLEY AREA, 25FT. A&B

964523-01	Galley assembly
964524-01	Galley top assembly
964335	Galley flip-up shelf
963990	Magazine rack
964980-01	Sink cover
964151	Galley roof locker assembly
964116	Pantry/wardrobe assembly
964162	Pantry assembly
381400	Slides, 14", pantry, pr.
964149-01	Refrigerator cabinet assembly
964172	Close out, refrigerator cabinet
964532	Spice rack
372203-05	Mirror, safety glass 19: x 14"

2000 SAFARI

GALLEY AREA, 27FT. A&B

964467-01	Galley assembly
964468	Galley top assembly
964335	Galley flip-up shelf
963990	Magazine rack
964980-01	Sink cover
381615	Tray, plastic, 11"
964469	Galley roof locker assembly
964623	Pantry/microwave cabinet assy.
964507	Pantry assembly
381400	Slides, 14", pantry, pr.
964508	Top, pantry cabinet
964472	Refrigerator cabinet assembly
964532	Spice rack
372203-05	Mirror, safety glass, 19" x 14"

2000 SAFARI

FURNITURE

LOUNGE AREA, 23&25FT. "C" MODEL

964150	Credenza assembly(23ft. only)
964338-01	Top, credenza assembly
960420-07	Table, lift up assembly
960416-06	Leaf, table, lower 24 x 25.88"
960417-07	Leaf, table, upper 24 x 25"
962117-03	Table leg, hardwood, 30.50"
960419-01	Facer board, lift up table
702798-337	*Sofa, jackknife, 74", Cabin Creek
963400-01	Arm rest support, RS
963400-02	Arm rest support, CS
962563	Close out, lounge, rear
964174	Close out lounge

*Changing the -(dash) number to: 118= Cypress Gardens
128= Starlight
159= Kodiak
169= Rain Forest

2000 SAFARI

FURNITURE

LOUNGE AREA, 25FT. A&B MODELS

964150	Credenza assembly
964338-01	Top, credenza assembly
960420-07	Table, lift up assembly
960416-06	Leaf, table, lower 24 x 25.88"
960417-07	Leaf, table, upper 24 x 25"
962117-03	Table leg, hardwood, 30.50"
960419-01	Facer board, lift up table
381306	Slides, pair, lift-up table
702798-337	*Sofa, jackknife, 74", Cabin Creek
963400-01	Arm rest support, RS
963400-02	Arm rest support, CS
962563	Close out, lounge, rear
964174	Close out lounge

*Changing the -(dash) number to: 118= Cypress Gardens
128= Starlight
159= Kodiak
169= Rain Forest

2000 SAFARI

FURNITURE

LOUNGE AREA, 27FT. A&B MODELS

964622	Credenza assembly
964509	Top, credenza assembly
960420-02	Table, lift up assembly
960416-02	Leaf, table, lower 24 x 25.88"
960417-02	Leaf, table, upper 24 x 25"
962117-03	Table leg, hardwood, 30.50"
960419-01	Facer board, lift up table
702798-337	*Sofa, jackknife, 74", Cabin Creek
963400-01	Arm rest support, RS
963400-02	Arm rest support, CS
962563	Close out, lounge, rear
964174	Close out lounge

*Changing the -(dash) number to: 118= Cypress Gardens
128= Starlight
159= Kodiak
169= Rain Forest

2000 SAFARI HARDWARE

MAIN DOOR LOCK

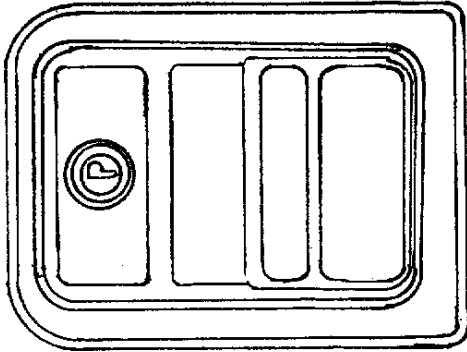

381547-01
Main door lock, outside
Housing

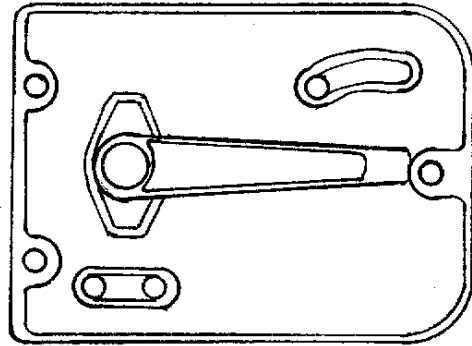

381547-02
Main door lock, inside
plate

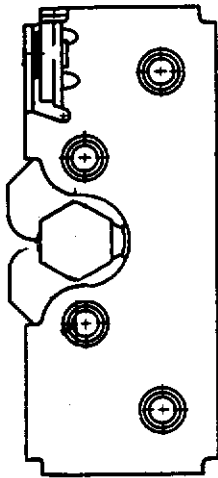

381547-03
Double rotary latch,
main door lock

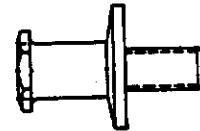

381547-04
Striker bolt w/washer
main door lock

Not shown:

381547-05 Screw package, main door lock

2000 SAFARI
HARDWARE
EXTERIOR LATCHES/LOCKS

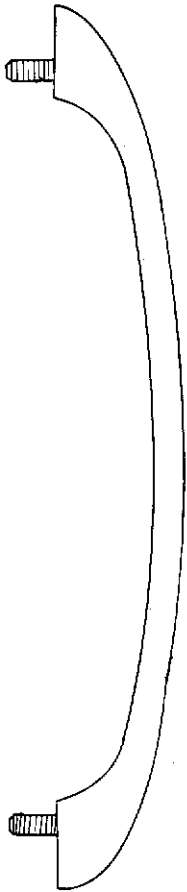

101171
Grab handle, main door

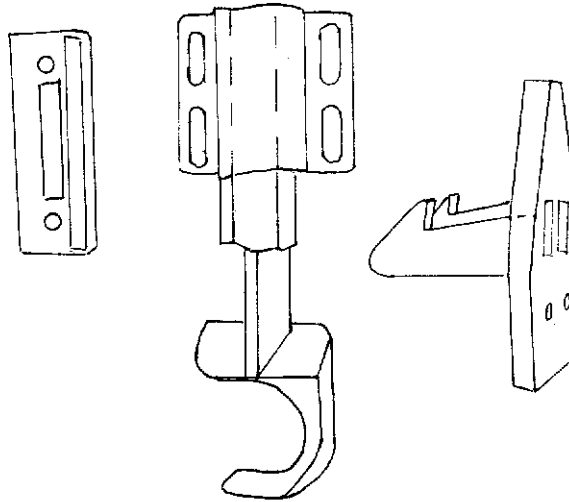

381454
Latch, screen door, Bullet

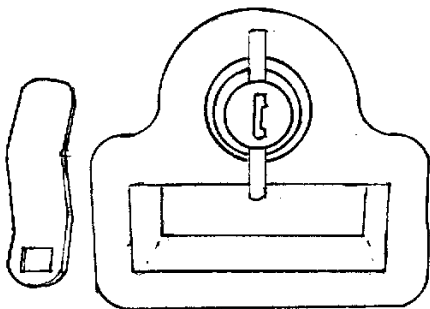

380770-101 Twist lock, chrome
380770-102 Twist lock, black

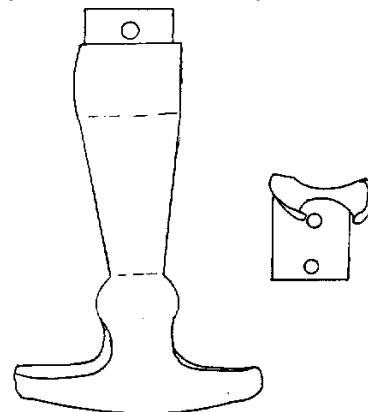

381021 Rubber T handle

2000 SAFARI HARDWARE

EXTERIOR LATCHES/LOCKS

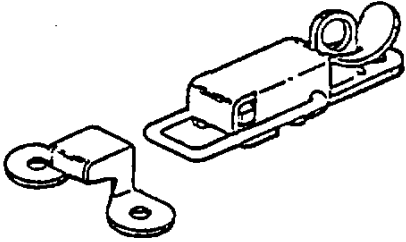

340023 Corbin catch
w/strike, battery box



380067 Lock cam,
bumper lid

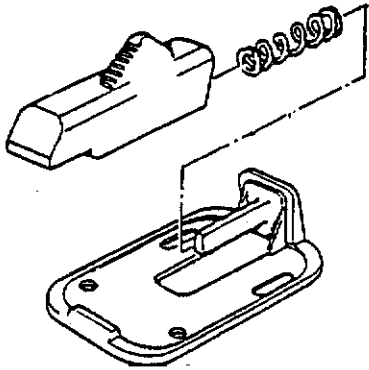

380291 Main door holdback,
(use w/housing #380290)

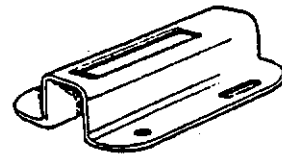

380290 Latch housing,
main door holdback

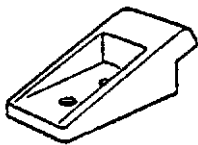

201056 Catch, main door
holdback

2000 SAFARI
HARDWARE
EXTERIOR LATCHES/LOCKS

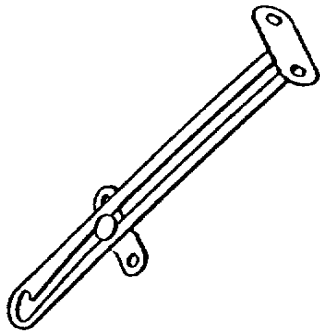

380024 Support arm,
bumper lid

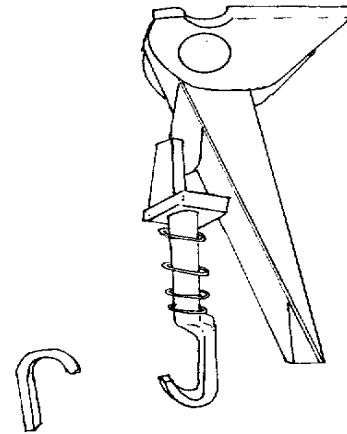

380903 Latch w/strike,
chrome, gas bottle cover

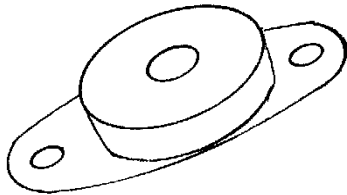

685359
Rubber receptacle
1/4" latch, Southco

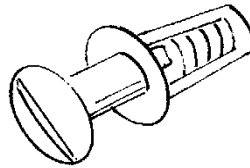

685342
Stud, 1/4" turn latch
Southco 1/4" turn stud



685362
Retaining ring

EXTERIOR HINGES

- 381552-03 Hinge assembly, main door, upper
- 381552-04 Hinge assembly, main door, lower
- 381531-01 Hinge, screen door, upper
- 381531-02 Hinge, screen door, lower

- 380773 Hinge, access door, 13 1/4"
- 380203-01 Piano hinge, 1/8" pin, clear anodized, hose carrier lid

2000 SAFARI HARDWARE

INTERIOR LATCHES/HINGES

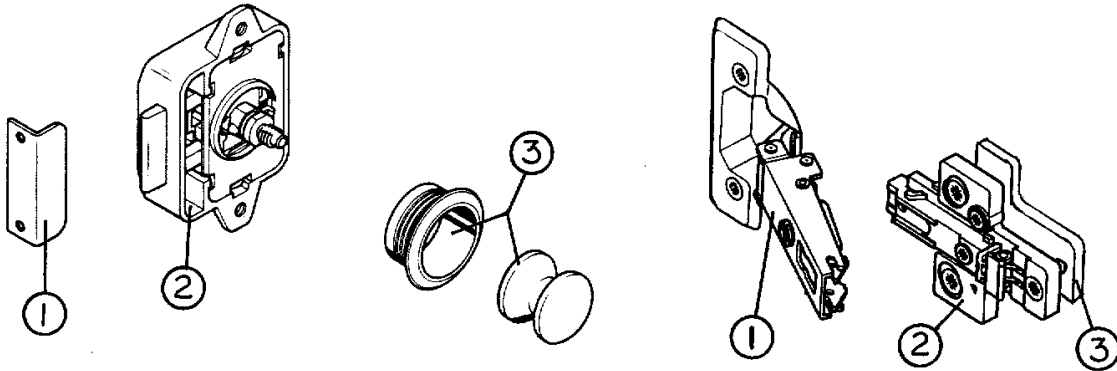

- 1) 381608-07
- 2) 381608-02
- 3) 381608-03

- 1) 381607-01 Hinge, cabinet
- 2) 381607-02 Base, metal
- 3) *381607-03 Base, plastic

*Not used in all applications

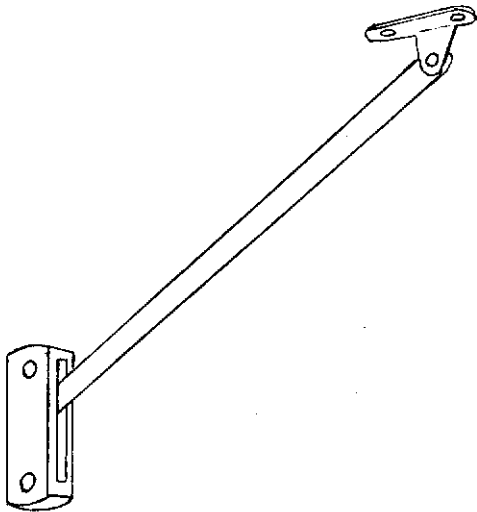

- 381608-04 Support arm, roof locker,
- 381608-05 Support arm, roof locker,

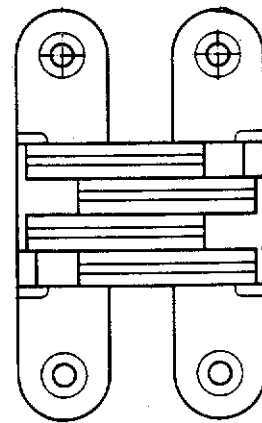

- RH380040 Soss hinge,
- LH lift up table

2000 SAFARI HARDWARE

INTERIOR LATCHES/HINGES

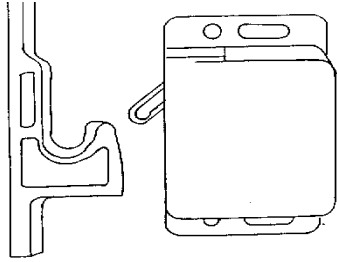

381228 Grabber door
latch w/catch, 10lb. rating
381228-01 Grabber door
latch w/catch, 3lb. rating



381228-100
Catch only, grabber
door latch

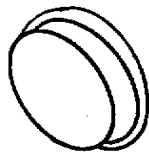

201427 Finger pull,
light brown



381603 Pull, three finger
Antique brass



360012 Bumper, rubber
white, stick-on, cylindrical

360012-01 Bumper, rubber
brown, stick-on, cylindrical

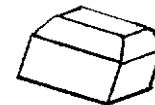

360016 Bumper, rubber
gray, square 3/8" x 3/8"

2000 SAFARI HARDWARE

INTERIOR LATCHES/HINGES



81599 Handle drawer/door

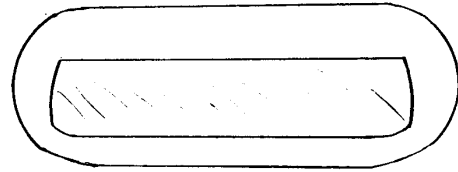

1576 Pull handle, brass



381444 Hatch pull, SST
satin finish

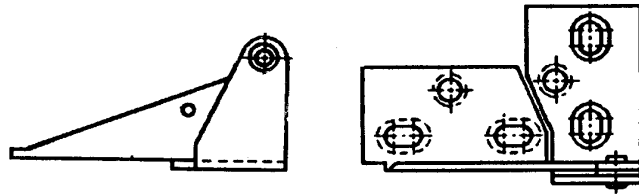

5935-01 Hinge pivot,
plated

2000 SAFARI

HARDWARE

DRAWER SLIDES

381526-01	Drawer slide-950-RV, 14"
381526-03	Drawer slide-950-RV, 18"
381414-144	Slide, drawer-Delta, 14.5"
381400	Slide, drawer, 14", 2900-14 (pantry)

BATHROOM ACCESSORIES

380034	Toilet paper holder, chrome
381259-01	Towel bar, 18", chrome
380259-03	Brackets, chrome towel bar
380248	Soap dish
381599-01	Drawer pull, chrome

HINGES

380458	Hinge, piano, 3/32 pin, 5/8" leaf, brown
380210	Hinge, 2" metal, bed top
380040	Soss hinge, #204, lift up table
381614	Folding shelf bracket, galley

TABLE HARDWARE

381306	Lift up table slides, one right & one left
201155	Table sliding guide, plastic
380037	Latch, nail & spring, table
380038	Eyelet, lock, brass
380040	Hinge, flush mount, Soss
381147	Support, spring loaded

WARDROBE

380045	Clothes rod
200975-04	Conduit, flexible, black (covers clothes rod)
380046	Bracket, clothes rod

2000 SAFARI

HARDWARE

MISCELLANEOUS

701342-01 Vinyl strap, sliding door hold back
(female snap on both ends)

381100 Sliding door guide

701624 Velcro loop, 5/8" wide

701625 Velcro hook, 5/8" wide

*381385 Dual lock #400-1" strips

*381386 Dual lock #170-1" strips

*These two parts work similar to Velcro but have interlocking knobs rather than hooks and loops.

2000 SAFARI

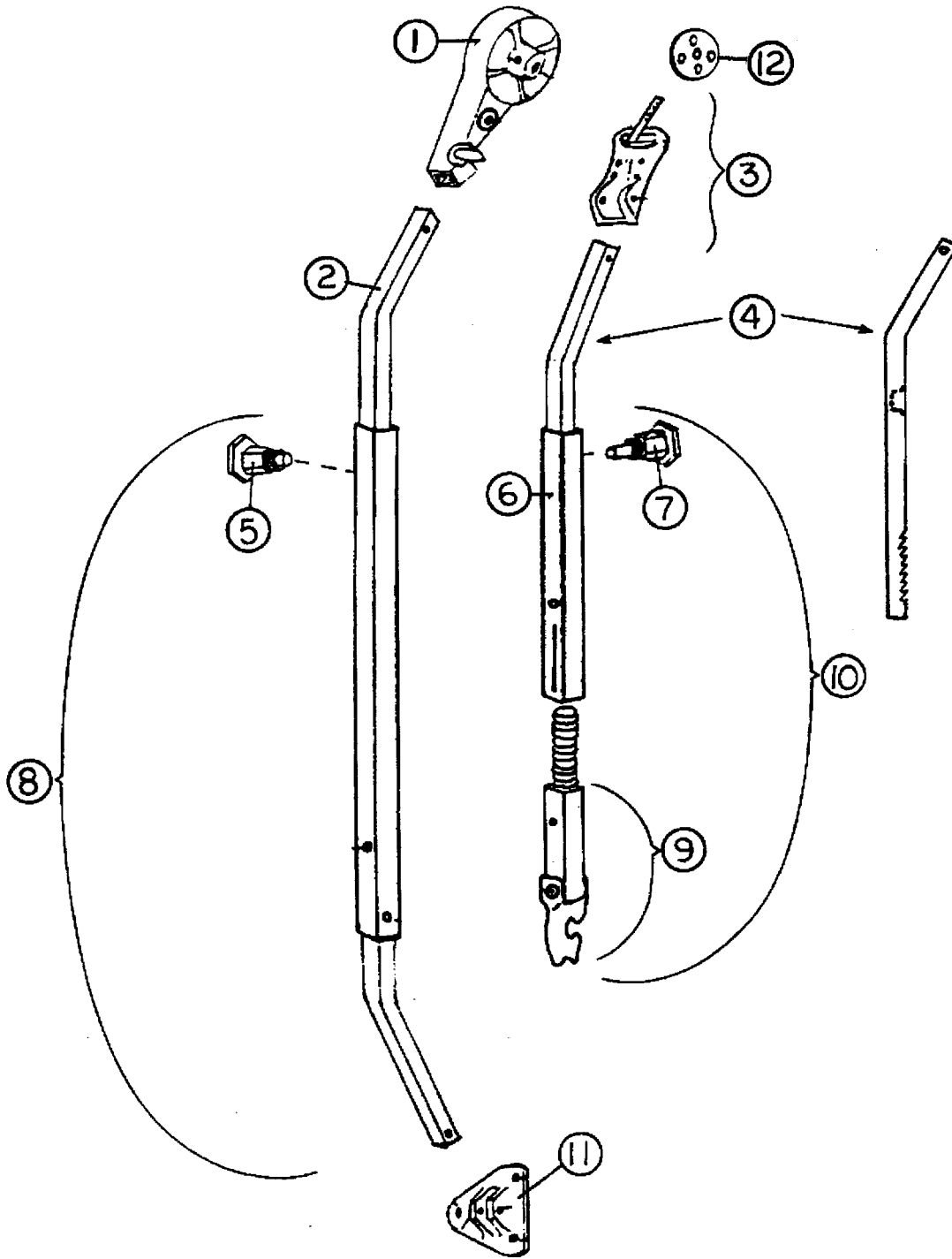

2000 SAFARI

HARDWARE

AWNING HARDWARE

- | | |
|----------------|---------------------------------------|
| 1) 702662-100 | Head assembly, front or rear |
| 2) 702662-101 | Main arm bar, front or rear |
| 3) 702622-103 | Clamp assembly, front, curved |
| 3a) 702662-104 | Clamp assembly, rear, curved |
| 4) 702662-105 | Rafter arm bar, satin |
| 5) 702662-106 | Snap stud assembly |
| 6) 702662-107 | Rafter arm tube, satin |
| 7) 74072W | Ratchet stud |
| 8) 74048W | Main arm tube assembly, front or rear |
| 9) 702662-110 | Claw bar assembly |
| 10) 702662-111 | Rafter arm assembly |
| 11) 702662-112 | Base hinge, rib mount |
| 12) 702662-114 | Clamp wheel |

2000 SAFARI

SECTION IV

L through Z

LABELS and TAGS IV-1

PLUMBING

LPG IV-2

Fresh water..... IV-3

Drain water..... IV-8

Toilet IV-12

SAFETY EQUIPMENT IV-14

SEALER/GASKETS/PAINT IV-15

UPHOLSTERY/FOAM/MATTRESS..... IV-16

VENTS/FANS IV-17

WOOD/LAMINATES/TRIM IV-18

2000 SAFARI

LABELS AND TAGS

385193	Label, "12V distribution panel inside"
385048	Label, approval with shield
385269	Label, "DON'T USE AREA FOR STORAGE"
385068	Tag, cooking appliance warning
385067	Label, EXIT
385547	Label, LP gas warning/fill
385517	Label, kill switch warning
385521	Label, emergency egress window
385463	Warning label/cooking appliance
385464	Label, LP gas warning label(odor)
385465	Exit label, English
385560	Label, air conditioner rating
385812	Label, Calif. hazardous substance
385609	Label, smoke detector
385359	Label, microwave or air conditioner
385837	Label, refrigeration ignition
385103	Plate, RVIA
385418-01	Label, Federal registration
385062	Decal, 110-125 voltage AC
385565	Label, holding tank flushing
385972	Label, fuse 12volt

2000 SAFARI

PLUMBING

LPG SYSTEM

601710-01	LP gas bottle, 30lb. steel
601686	Base plate, LP tank mounting
601687	Hold down kit, LP tank
601731	LP regulator, Marshall Brass w/pigtails, mounting bracket & cover
601731-100	LP pigtails, 15in.
601684-101	Bracket, mounting, LP regulator
601684-102	Cover, Marshall Brass regulator
601412-12	Connector, 1/2 P x 5/8 copper
601685-01	LP hose, 1/2 FPT x 3/8 flare
600468	Union flare, 5/8 x 5/8
600238	Union flare, 3/8 x 3/8
600004	Copper tubing, 5/8
600008	Copper tubing, 3/8
600436	Flare nut, forged, 5/8
600435	Flare nut , forged, 3/8
600000	Tee, brass, 5/8 x 5/8 x 3/8
600003	Tee, brass, 5/8 x 3/8 x 3/8
104264-01	Gas bottle cover w/o decal
380903	Latch and strike
200841	Lid, plastic, bottle cover
380773	Hinge, access door

2000 SAFARI

PLUMBING FRESH WATER

601194	Water fill w/lock, gray
601643	Tank, fresh water
601243	Drain cock, fresh water tank
600155	Plug, water tank, 1.5"
600836	Elbow, 1/2" barb x 3/8" MPT
601237	Plastic elbow, 90 degree, 1.25" MPT x 1.25" barb
601239	Tubing, 1.375" I.D., flexible, water fill hose
601061-03	Water pump, Shurflo
600668	Filter, pre water pump
601588	Drain cock, brass, water line drain

CITY WATER

600362	Connector, 1/2" FPT x water hose, swivel
600336	Plug with chain
601690	Nipple, 1/2" MPT x 2.50"
601689	Drop ell, 90 degree, 1/2" FPT
600309	Regulator, Watts, 1/2" FPT

FITTINGS

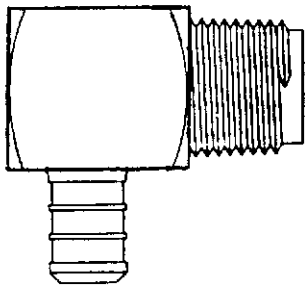

601698-04
Elbow, 1/2" barb
x 1/2" MPT

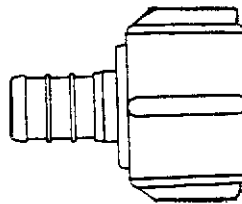

601698-03
Coupler, 1/2" barb
x 1/2" FPT

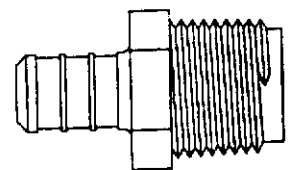

601698-02
Coupler, 1/2" barb
x 1/2" MPT

(continued)

2000 SAFARI
PLUMBING
FRESH WATER-FITTINGS

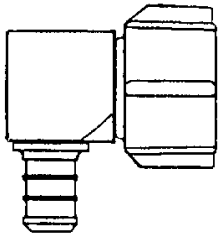

601698-05
Elbow 1/2" barb x
1/2" FPT

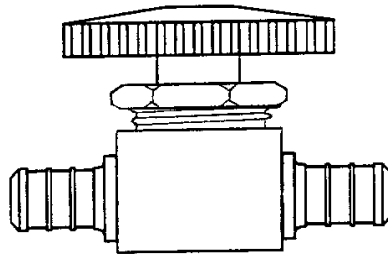

601698-07
Shut-off, 1/2" barb x
1/2" barb

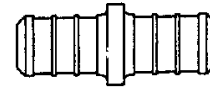

601698-08
Coupler
1/2" x 1/2" barb

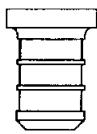

601698-09
Plug, 1/2" barb

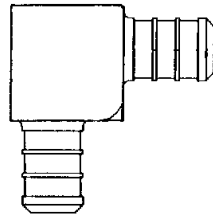

601698-10
Elbow 1/2" barb x
1/2 barb

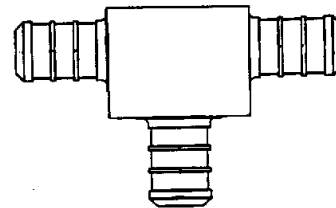

601698-11
Tee, 1/2" x 1/2" x
1/2 barb



601698-15
Crimp ring, 1/2"
E-Pex, 1/2" (black)



601698-01
E-Pex tube, 1/2"

2000 SAFARI
PLUMBING
FRESH WATER FAUCETS

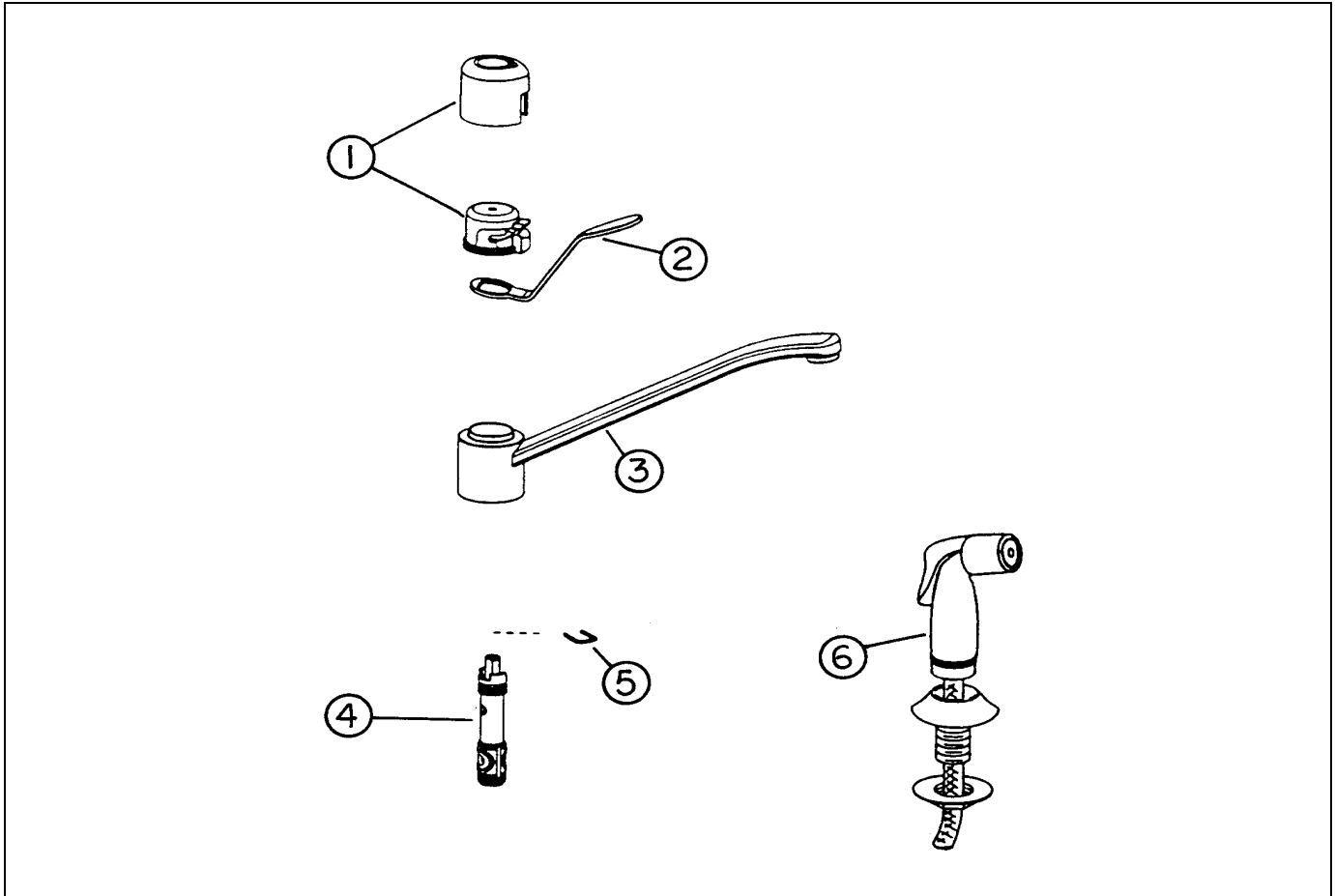

601746 Galley faucet, Moen Manor

- | | |
|---------------|------------------------------------|
| 1) 013098 | Galley lever handle set, Moen |
| 2) 601746-100 | Lever handle, Moen |
| 3) 601746-101 | Spout assembly, 9" Moen |
| 4) 601579-106 | Cartridge, Moen #1225 |
| 5) 601579-105 | Horseshoe clip, cartridge retainer |
| 6) 601418-100 | Spray head and hose, Moen |

2000 SAFARI
PLUMBING
FRESH WATER FAUCETS

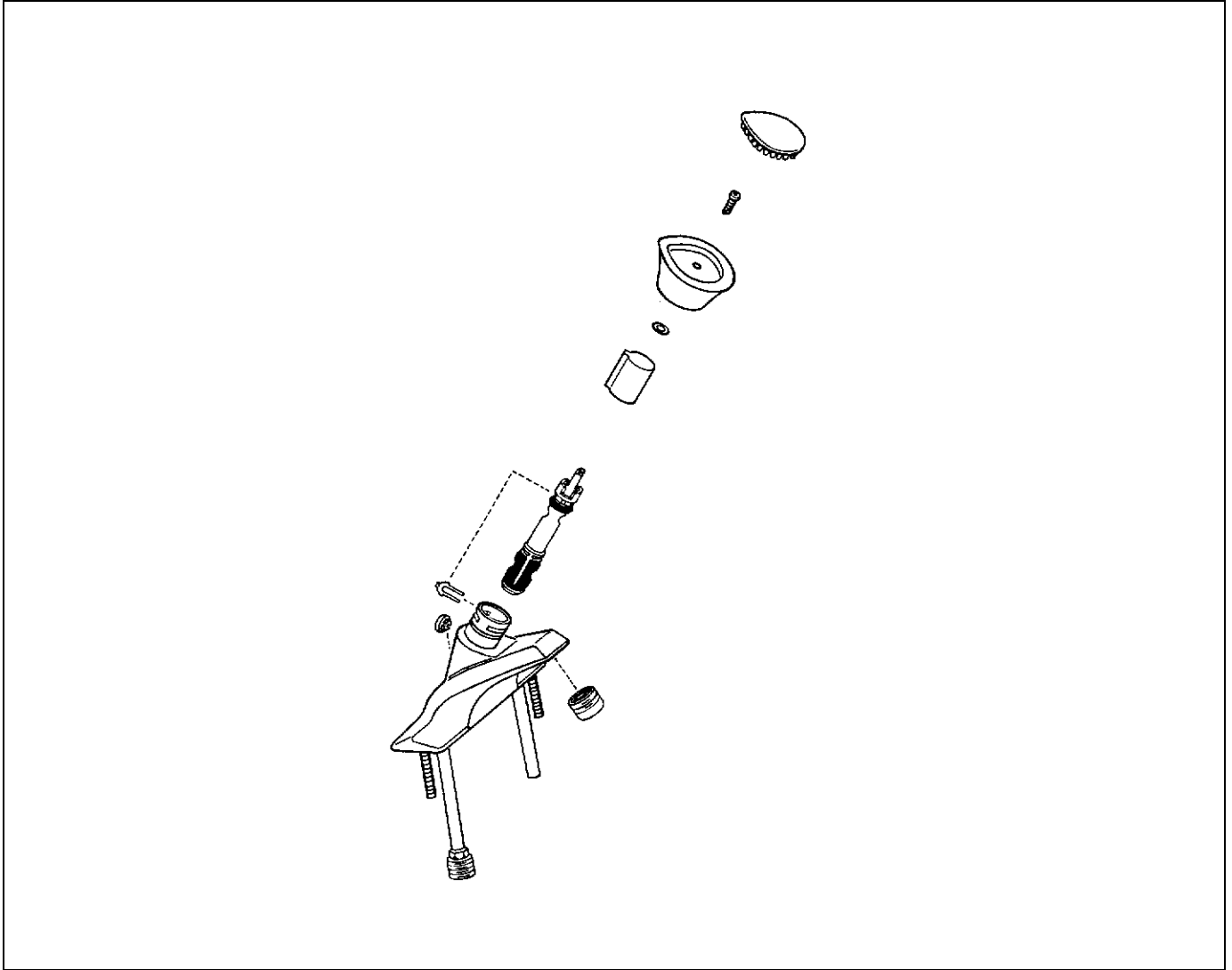

601419-01 Faucet, lavatory, Moen, chrome

- 1) 001245 Knob
- 2) 601579-105 Cartridge
- 3) 601579-104 Retainer clip

2000 SAFARI

PLUMBING FRESH WATER-FAUCETS

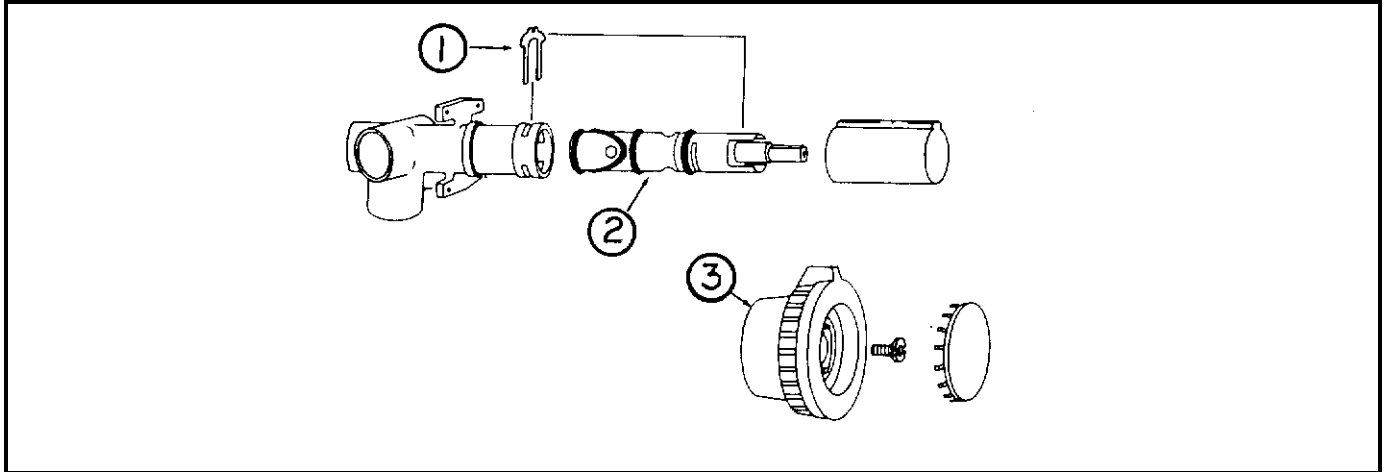

601420-01Faucet, shower

- | | |
|---------------|---------------|
| 1) 000883 | Retainer clip |
| 2) 601420-100 | Cartridge |
| 3) 001041 | Handle |

Not shown:

601358 Shower kit, includes: shower hose, showerhead,
Vacuum breaker, wall mounts

2000 SAFARI

PLUMBING DRAIN SYSTEM

Gray tanks

601622-04	Holding tank, gray-27ft.
601623-08	Holding tank, gray-23 & 25ft."C"
601623-07	Holding tank, gray-25ft."A&B"

Black Tanks

601623-09	Holding tank, black-27ft.
601458	Holding tank, black-23 & 25ft."C"
601542	Holding tank, black-25ft. "A&B"

Sink/showers

203046-03	Shower stall, two-piece, angled-27ft.
201980	Shower stall, two-piece, 25ft. "A & B"
203114	Shower stall, two-piece, 23 & 25ft. "C"
600594	Tub strainer w/rubber stopper
601744-02	Sink, porcelain, galley, Almond
600968	Basket strainer
601498	Sink, lavatory, rectangular, 27ft.
200406-06	Lavatory bowl, oval (includes stopper, basket and tail) 23 & 25ft.

2000 SAFARI

Drain Tank Valves

601607-11	Valve assembly, 3" spigot x 3" spigot
601607-13	Valve assembly, 3" hub x 3" spigot, 27ft.
601607-02	Valve assembly, 3" hub x 3" spigot, 23 & 25ft.
601470	Dump valve, Valterra, T-68, heel in.
601607-12	Valve assembly, 1.5" hub x 1.5" spigot
600187	Wye, 3" comb & 1/8" bend
600820	3" single socket, 90 degree
600289	Calder coupling, 3" rubber
601607-06	Adapter, 3" hub x 3" bayonet
601607-07	Cap, termination, 3" bayonet
601607-10	Extension rod, 19"
601607-03	Extension rod, 12" threaded
114086	Bracket, dump valve handle

1 1/2" DRAIN FITTINGS

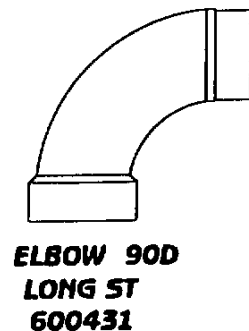
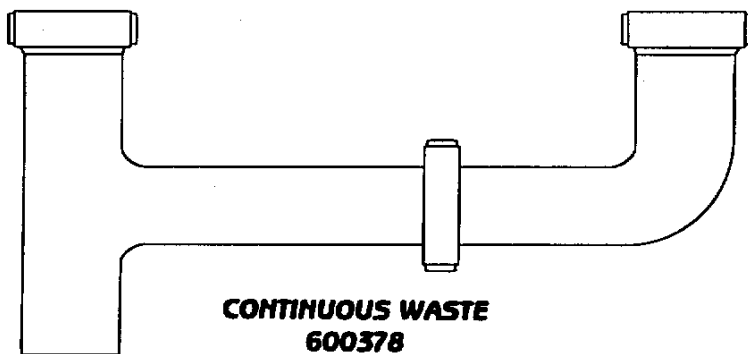

(continued)

2000 SAFARI
PLUMBING
DRAIN FITTINGS, 1.5"

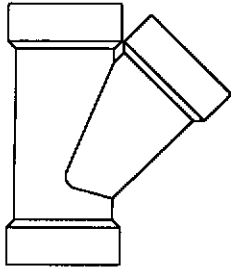

**WYE
#2301
600094**

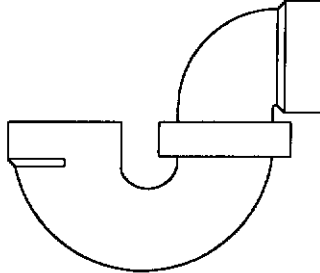

**P-TRAP
1.5" W/O SLIP NUT
600144**

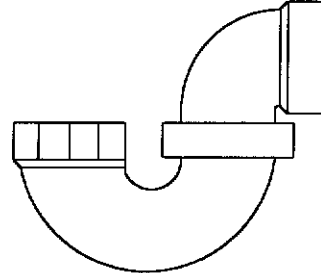

**P-TRAP
1.5" WITH SLIP NUT
600622**

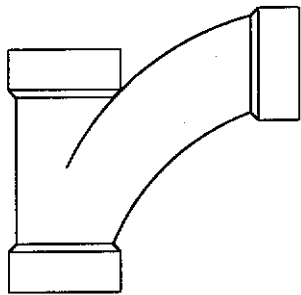

**WYE 1.5"
1/8" BEND
600182**

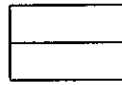

**COUPLING
1.5"
600227**

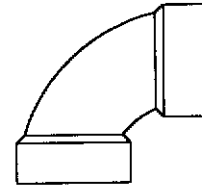

**ELBOW 90D
SHORT SWEEP
601636**

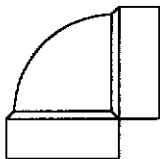

**ELBOW VENT
90D
600033**

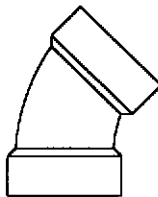

**ELBOW 45D
LONG TURN
600030**

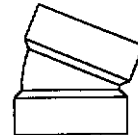

**ELBOW 22.5D
SHORT TURN
600116**

(continued)

2000 SAFARI
PLUMBING
FITTINGS, 1.5" PLASTIC

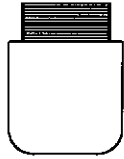

VENT 1.5"
600538



PLUG 1.5"
600155



CAP 1.5"
601677

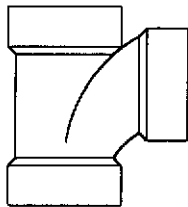

TEE-SANITARY
1.5"
600156

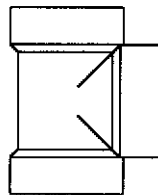

TEE-BI DIRECTIONAL
CLEAN-OUT 1.5"
601318

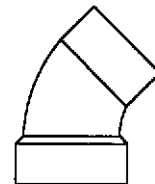

ELBOW 45D
LONG ST
600027

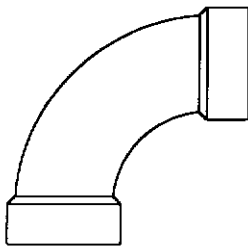

ELBOW 90D
LONG TURN
600035

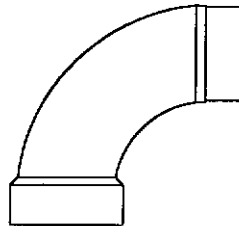

ELBOW 90D
LONG ST
600431

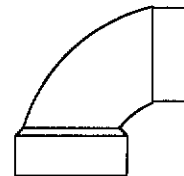

ELBOW 90D
SHORT ST
600662

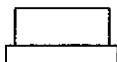

REDUCER 1.5" TO 1.25"
601263



ADAPTER
601676

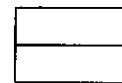

ADAPTER
W/FEMALE THREADS
600308

2000 SAFARI
PLUMBING
THETFORD, AQUA MAGIC IV, FOOT FLUSH, WHITE

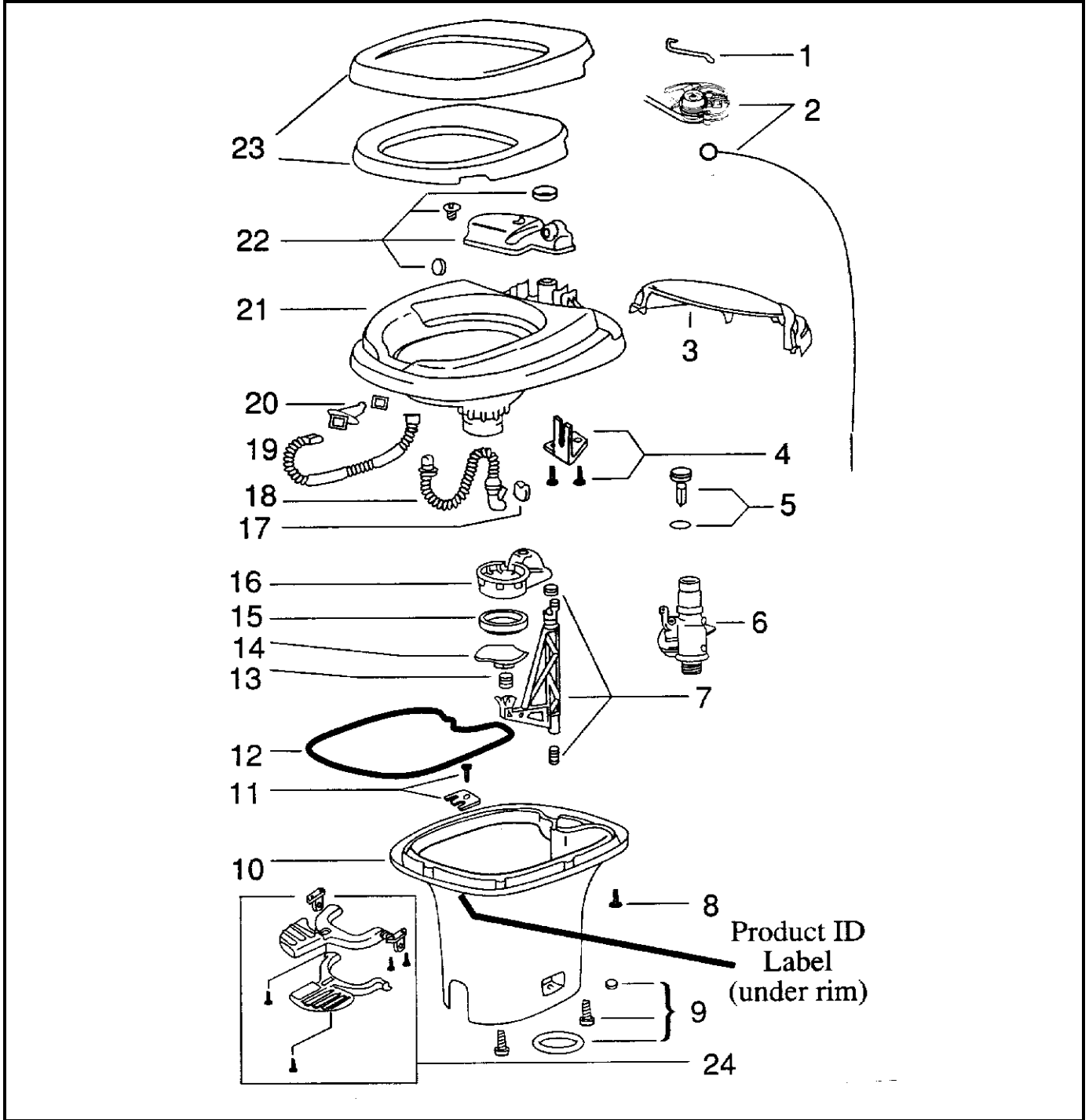

2000 SAFARI

PLUMBING

THETFORD, AQUA MAGIC IV, FOOT FLUSH, WHITE

690387	Toilet complete, Aqua Magic IV, low, 23 & 25
690387-01	Toilet complete, Aqua Magic IV, high, 27ft.
1) 690327-513	Water valve link
2) 690327-571	Wire replacement package
3) 690327-562	Mechanism cover, white
4) 690327-634	Bracket assembly
5) 690327-631	Float assembly
6) 690327-168	Water valve replacement package
7) 690327-632	Actuator assembly
8) 690327-659	Screw base to bowl
9) 690327-524	Closet bolt package
10) 690327-356	Base, white, low
10a) 690327-062	Base, white, high
11) 690327-636	Retainer assembly
12) 690327-387	Sealant, base to bowl
13) 690327-519	Blade spring
14) 690327-262	Blade
15) 690327-481	Blade seal
16) 690327-520	Blade track
17) 690327-512	Flapper
18) 690327-511	Overflow tube
19) 690327-509	Flush tube
20) 690327-637	Nozzle assembly
21) 690327-726	Bowl
22) 690327-630	Reservoir tank assembly
23) 690327-162	Seat and cover assembly
24) 690327-821	Pedal package

2000 SAFARI

SAFETY EQUIPMENT

510781	Smoke detector
511309	LPG detector
600162-01	Fire extinguisher

2000 SAFARI

SEALER/GASKETS/PAINT

SEALER

6000360	Sealant, Butyl #884058
360001	Sealant, #884058
360002	Sealant, Vulkem 11.5 oz. tube
360209	Sealant, seam
360176	Sealant, Almond, kitchen and bath
360180	Sealant, Sikaflex #221
360210	Sealant, Paralastic 4334-014
360283	Sealant, silicone, Corian Bone

GASKETS



365035 Gasket
access doorjamb



365013-01 Gasket
screen door



365232 Gasket
main door



371593-711 Glazing
rubber, Creation
window



371593-713 Seal
plastic, sash
Creation window



371593-712
Foam seal, sash
Creation window

381665	Gasket, D seal, window frame to shell
380226	Gasket, taillight lens
380114	Gasket, vent pip
365016	Tape, foam, double face, 1/2" wide
365001-02	Tape, vinyl foam, double face, 3/4" wide
380222	Tape, acrylic foam, double face, 3/4" wide

360213	Paint, aluminum metallic
360151	Paint, gray metallic, Centari
360260	Paint, Pewter
360200-01	Hardener, Centari
360292	Stain, Saratoga Oak

2000 SAFARI

UPHOLSTERY/FOAM/MATTRESS REAR BEDROOM

702819	Mattress, twin, 32" x 78", 25 & 27ft."A"
702705	Mattress, double, 60" x 75", 25 & 27ft."B"
702704	Mattress, double, 52" x 75", 23 & 25ft."C"
*702820-337	Bedsread, twin, Cabin Creek, 25 & 27ft."A"
702676-337	Bedsread, double, 75", Cabin Creek 25 & 27ft."B"
702541-337	Bedsread, corner double, Cabin Creek 23 & 25ft. "C"
702882-02	Pillow accent, sofa, Cabin Creek
701611	Pillow, 21" x 31", all models

FRONT LOUNGE

*702798-337	Sofa, jackknife, 74", Cabin Creek, all models
453368-03	Sofa legs, Flex steel
963400-01	Arm rest support, RS
963398-01	Arm rest cushion, RS
963400-02	Arm rest support, CS
963398-02	Arm rest cushion, CS

SIDE DINETTE, 25ft."C"(only)

998070-03	Cover, seat, side dinette
998071-03	Cover, backside dinette
702464-16	Foam, dinette upper back
702464-13	Foam, dinette lower back
702464-14	Foam, dinette aft seat
702464-15	Foam, dinette forward seat

*Changing the dash number changes the upholstery color:
-128 =Starlight, -118 = Cypress Gardens,
-159 =Kodiak, -169 =Rain Forest

2000 SAFARI

VENTS/FANS

100341	Refrigerator, vent collar, large
101394	Cover, refrigerator vent, large
101158	Vent pipe cover, cast aluminum
380114	Gasket, vent pipe
381606-01	Vent, roof, 14 x 14", non-power, white
381606-02	Trim ring, interior, roof vent, white
381153-01	Vent, Jensen#757, square
511341-01	Range hood
511017-11	Vent cover, exterior, range hood, gray
690266-01	Ventilator, power, bath, 25ft.

2000 SAFARI

WOOD/LAMINATES/TRIM

PLYWOOD

800506-04	Plywood, 1/2" x 4' x 8'
800976-01	Plywood, tongue and groove, 19/32'(floor)
800506-05	Plywood, 5/8" x 4' x 8'
800583	Plywood, Birch Baltes (cutting boards) 5/8" x 5' x 5'
801068-06	Plywood, G2S, 3/4" x 4' x 8'

PANELING

800507-02	Panel, Lauan, 1/4" x 4' x 8', raw/raw
800507-03	Panel, Lauan, 3/8" x 4' x 8', raw/raw
801191-004	Panel, G1S, 1/8" x 4' x 8', Oak vinyl
801261	Panel, G1S, 1/8" x 4' x 8', Antiquity Buff
801181-004	Panel, G1S, 5/32" x 4' x 8', Oak/raw
801182-004	Panel, G2S, 5/32" x 4' x 8', Oak/Oak
801283	Panel, G2S, 1/2" x 4' x 8', Antiquity Buff/Ant. Buff
801179-004	Panel, G1S, 1/2" x 4' x 8', Oak/raw
801274	Panel, G1S, 1/2" x 4' x 8', Antiquity Buff
801180-004	Panel, G2S, 1/2" x 4' x 8', Oak/Oak
801203-004	Panel, G2S, 1/2" x 4' x 8', Oak 6 mil
801183-004	Panel, G2S, 1/2" x 4' x 8', Oak/Antiquity Buff
365251-01	Tape, seam, Antiquity Buff, 1 1/8" wide
365251-02	Tape, seam, Antiquity Buff, 8" wide
365251-03	Tape, seam, Antiquity Buff, 12" wide

(continued)

2000 SAFARI

WOOD/LAMINATES/TRIM

LAMINATES

- 801229 Laminate, Oak, high pressure, .045-.050
801169 Laminate, Beige Pampas, .042 (galley top color)
- 801230 Pre-laminated panel, Oak, 5/8"x4x8, Lauan core
801212-01 Pre-laminated panel, Beige Pampas, 5/8"x4x8
- 801184-014 Laminated lumber core, .75 x 1.5 x 8ft.
801184-034 Laminated lumber core, .75 x 2.0 x 8ft.
801184-054 Laminated lumber core, .75 x 2.5 x 8ft.

TRIM

- 800766 Trim, hardwood, .50 groove x 8', panel edging
800405 Plug, hardwood button, screw cover

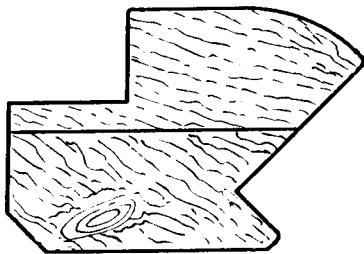

801209-004 Jamb,
bathroom door

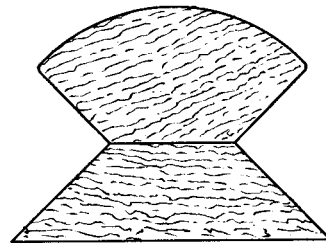

801282-004 Corner trim
1" radius

2000 SAFARI
WOOD/LAMINATES/TRIM

TRIM



801617-014 Molding
Wainscoat, oak

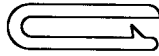

203225 Trim
lock, white



201728-03 Extrusion
plastic, ceiling trim, white

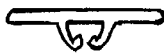

201728-01 Extrusion
ceiling trim retainer



203159-02 Trim,
divider bar

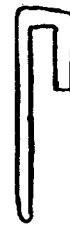

201666 Molding "J"
trim, plastic



203138-02 Extrusion, plastic
panel edging, brown

