

2001 350/355 XL  
TABLE OF CONTENTS  
SECTION I

A through C

APPLIANCES

<a href="#">Air conditioner</a> .....	I-1
<a href="#">Furnace</a> .....	I-1
<a href="#">Micro-wave</a> .....	I-1
<a href="#">Range</a> .....	I-2
<a href="#">Refrigerator</a> .....	I-2
<a href="#">Water heater</a> .....	I-3

BODY

<a href="#">CS wall</a> .....	I-5
<a href="#">RS wall</a> .....	I-7
<a href="#">Slide out extrusions</a> .....	I-8
<a href="#">Slide out gaskets</a> .....	I-9
<a href="#">Front end</a> .....	I-11
<a href="#">Aft end</a> .....	I-13
<a href="#">Roof</a> .....	I-14

CHASSIS

<a href="#">Hitch</a> .....	I-15
<a href="#">Power jacks</a> .....	I-15
<a href="#">Step</a> .....	I-15
<a href="#">Automotive air conditioner</a> .....	I-16
<a href="#">Auxiliary heater</a> .....	I-16

2001 350/355 XL  
TABLE OF CONTENTS  
SECTION II  
D through E

DASH

[Dash parts](#) ..... II-1

[DECALS & MEDALLIONS](#) ..... II-2

DOORS/WINDOWS/AWNINGS

[Roadside](#) ..... II-5

[Curbside](#) ..... II-7

[Main door & Screen Door](#) ..... II-9

[DRAPES/BLINDS/VALANCES](#)..... II-10

ELECTRICAL

[110 volt](#) ..... II-11

[12 volt, chassis](#) ..... II-13

[12 Volt General](#) ..... II-14

[Dash switches/lens](#) ..... II-17

[12-volt interior switches](#) ..... II-18

[12-volt interior lights](#) ..... II-18

[12-volt exterior lights](#)..... II-20

[12-volt misc.](#) ..... II-21

[Windshield wiper assy.](#) ..... II-23

ENTERTAINMENT

[Televisions](#) ..... II-24

[Radios](#) ..... II-24

[Rear view monitor](#) ..... II-25

2001 350/355 XL  
TABLE OF CONTENTS  
SECTION III  
F through H

FASTENERS (common fasteners available locally are not listed)

<a href="#">Rivets</a> .....	III-1
<a href="#">Screws</a> .....	III-3

FLOOR COVERING

<a href="#">Carpet</a> .....	III-4
<a href="#">Hardwood flooring</a> .....	III-4
<a href="#">Tile</a> .....	III-4
<a href="#">Mats</a> .....	III-4

FURNITURE

<a href="#">Interior doors</a> .....	III-5
<a href="#">Mirrors</a> .....	III-6
<a href="#">Drawer face</a> .....	III-7
<a href="#">Drawer box</a> .....	III-7
<a href="#">Bedroom furniture w/slide</a> .....	III-8
<a href="#">Bedroom furniture non slide</a> .....	III-10
<a href="#">Bath area</a> .....	III-12
<a href="#">Galley, slide out</a> .....	III-13
<a href="#">Cab and lounge, slide out</a> .....	III-15

HARDWARE

<a href="#">Exterior locks</a> .....	III-17
<a href="#">Main door/screen door</a> .....	III-18
<a href="#">Exterior lower compartment</a> .....	III-20
<a href="#">Slide out room</a> .....	III-23
<a href="#">Awning hardware</a> .....	III-25
<a href="#">Interior hardware</a> .....	III-26

2001 350/355 XL  
TABLE OF CONTENTS

SECTION IV  
L through Z

<a href="#">LABELS and TAGS</a> .....	IV-1
<a href="#">OPTIONS</a> .....	IV-3
PLUMBING	
<a href="#">LPG</a> .....	IV-5
<a href="#">Utility compartment</a> .....	IV-6
<a href="#">Fresh water</a> .....	IV-7
<a href="#">Faucets</a> .....	IV-9
<a href="#">Drain water</a> .....	IV-12
<a href="#">Toilet</a> .....	IV-16
<a href="#">SAFETY EQUIPMENT</a> .....	IV-19
SEALS/SEALER/PAINT	
<a href="#">Gaskets</a> .....	IV-20
<a href="#">Sealer</a> .....	IV-22
<a href="#">Adhesive</a> .....	IV-22
<a href="#">Paint</a> .....	IV-23
<a href="#">UPHOLSTERY/FOAM/MATTRESS</a> .....	IV-24
<a href="#">VENTS/FANS</a> .....	IV-30
<a href="#">WOOD/INTERIOR TRIM</a> .....	IV-31

# 2001 350/355 XL TABLE OF CONTENTS

## SECTION I

### A through C

#### APPLIANCES

Air conditioner .....	I-1
Furnace .....	I-1
Micro-wave.....	I-1
Range.....	I-2
Refrigerator.....	I-2
Water heater .....	I-3

#### BODY

CS wall .....	I-5
RS wall .....	I-7
Slide out extrusions .....	I-8
Slide out gaskets.....	I-9
Front end .....	I-11
Aft end .....	I-13
Roof .....	I-14

#### CHASSIS

Hitch .....	I-15
Power jacks .....	I-15
Step .....	I-15
Automotive air conditioner .....	I-16
Auxiliary heater.....	I-16



## 2001 350/355 LAND YACHT XL

### APPLIANCES

#### DUO THERM AIR CONDITIONER-BRISKAIR

690323-06	Air conditioner, Briskair 11, 000 BTU
690323-07	Air conditioner, Briskair 13, 500 BTU
690323-22	Relay kit, analog control
690323-20	Thermostat, analog
690323-103	Shroud, exterior, Briskair
385582-01	Decal, Airstream w/bar
203069	Register, white, 4" x 8"
690323-12	Cover, return grill

#### FURNACE, HYDROFLAME (800-825-4328) Dealer only

690274	Furnace, Hydroflame, #8535-IV, 34000BTU
690244-06	Mounting flange
690274-06	Door exterior, Hydroflame
601244-03	Register, Rotaire, black
203070	Grille, 2" x 10", brown
600247	4" duct hose, flexible

#### MICROWAVE

690368-01	Microwave/convection oven, Sharp
690345-03	Trim ring, microwave mounting

# 2001 350/355 LAND YACHT XL

## APPLIANCES

### RANGE

690396-06 Range top, 3-burner, Magic Chef  
690396-03 Range cover, bi-fold  
964383-01 Range covers, Corian, set

### DOMETIC REFRIGERATOR, RM3862R (800-366-3842)

690370-01 Refrigerator, 2-way, RH, RM3862R  
801225-014 Door panel, upper, Oak, 15.5x20.38"  
801225-034 Door panel, lower, Oak, 38.38x20.38  
690370-100 Cooling unit, RM3862  
381207-03 Vent, roof, Dometic, polar white  
690259-03 Access door, w/mounting flange, exterior



# 2001 350/355 LAND YACHT XL

## APPLIANCES

### ATWOOD WATER HEATER, GC6AA-9E

- 690406 Water heater, Atwood, elec. ignition, 110 volt/gas
- 500933 Switch, water heater, electronic
- 690259-05 Access cover, white

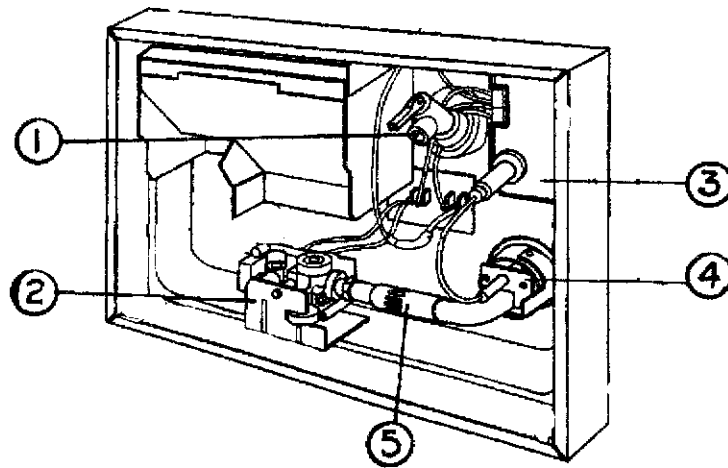

Front of water heater

- 1) 091604 Relief valve, pressure/temperature
- 2) 093870 Solenoid valve
- 3) 093865 Circuit board
- 4) 093868 Spark probe
- 5) 092615 Main burner

Back of water heater

- 091160 heating element, 110volt
- 091873 ECO thermostat
- 091092 On/off switch, 110Volt

# 2001 350/355 LAND YACHT XL

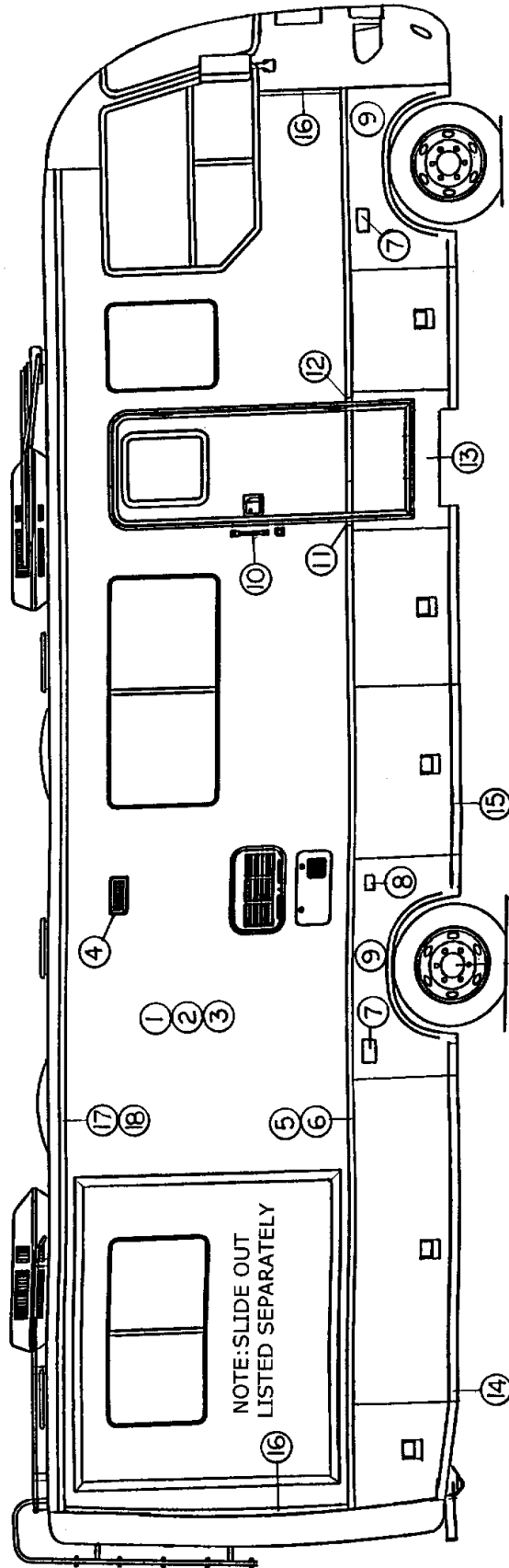

## 2001 350/355 LAND YACHT XL

See previous page for drawing  
CURBSIDE WALL

- 1) 801002-08 Sheet, fiberglass, Frost White, 77.5" x 384"
- 2) 801261 Panel, interior, G1S, 1/8" x 4' x7', Antiq. Buff
- 3) 203075 Styrofoam sheet, 1 1/2"
- 4) 510672-02 Porch light, white
- 5) No vinyl trim on unit. 114865 is painted.
- 6) 114865 Extrusion, rub rail, 18'
- 7) 511101-01 Light, docking, stainless steel
- 7a) 201991 Housing, docking light
- 8) 511250-02 Light, side marker, amber
- 9) 203171 Fender skirt, front and rear
- 10) 381696 Grab handle, embossed "AIRSTREAM"
- 11) 114914-02 Cap, end, rub rail extrusion, LH
- 12) 114914-01 Cap, end, rub rail extrusion, RH
- 13) 203179 Panel, skirt, main door
- 14) 114717-07 Weldment, rocker panel, CS
- 15) 114708-01 Extrusion, rocker panel
- 16) 114862-01 Extrusion trim end cap to sidewall
- 17) 114619 Extrusion, roof corner cap
- 18) 114570 Extrusion, awning rail

# 2001 350/355 LAND YACHT XL

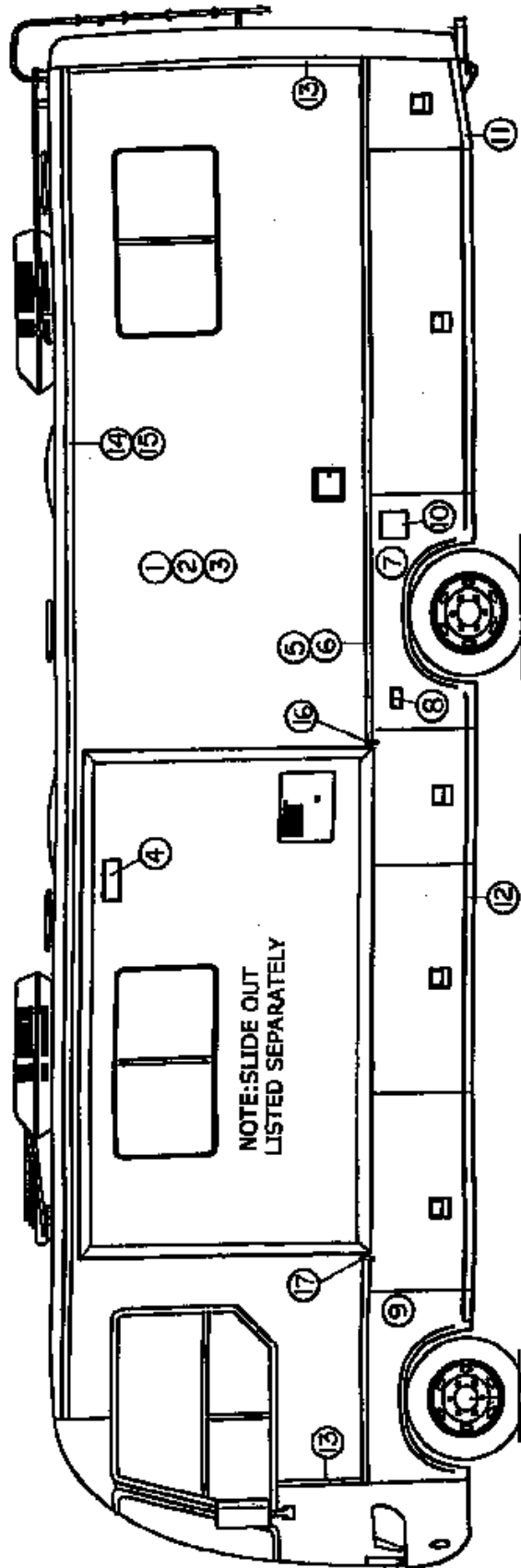

## 2001 350/355 LAND YACHT XL

### ROADSIDE WALL

- 1) 801002-08 Sheet fiberglass, Frost White, 77.5" 384"
- 2) 801261 Panel, interior, G1S, 1/8 x 4' x7' Antiquity Buff
- 3) 203075 Styrofoam sheet, 1 1/2"
- 4) 511152-01 Vent cover, range hood, white
- 5) No vinyl trim on unit. 114865 is painted.
- 6) 114865 Extrusion, rub rail, 18'
- 7) 203172 Fender skirt w/fuel fill
- 8) 511250-02 Light, side marker, amber
- 9) 203171 Fender skirt, front
- 9a) 203172 Fender w/fuel fill, rear
- 10) 203047 Bezel, fuel fill
- 11) 114717-08 Weldment, rocker panel, RS
- 12) 114708-01 Extrusion, rocker panel
- 13) 114862-01 Extrusion trim end cap to sidewall
- 14) 114619 Extrusion, roof corner cap
- 15) 114570 Extrusion, awning rail
- 16) 114917-01 End cap, rub rail, RH, at slide out
- 17) 114917-02 End cap, rub rail, LH, at slide out

# 2001 350/355 LAND YACHT XL

## SLIDE OUT EXTRUSION

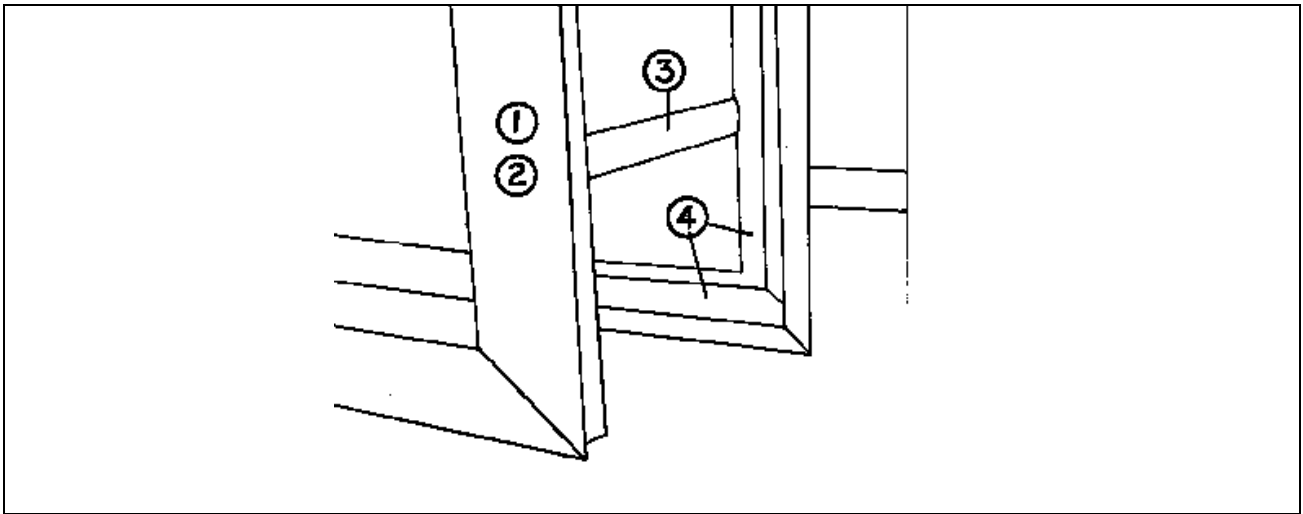

Lower rear corner, extended

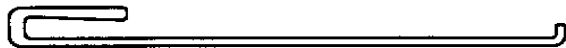

\*1) 114771 Extrusion, slide out trim

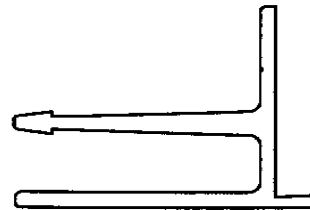

114770, Extrusion, slide out box (fits behind 1)

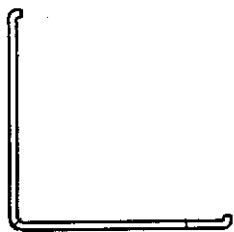

3) 114768 Extrusion, slide out corner trim

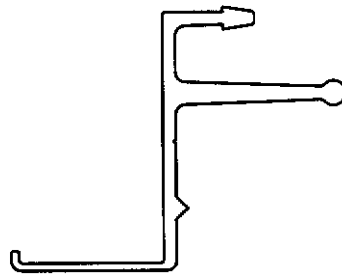

4) 114726 Extrusion, slide out frame

\*This trim is slotted to allow adjustment to the sidewall Cutout. Fitting will be required.

# 2001 350/355 LAND YACHT XL

\* SLIDE OUT GASKETS

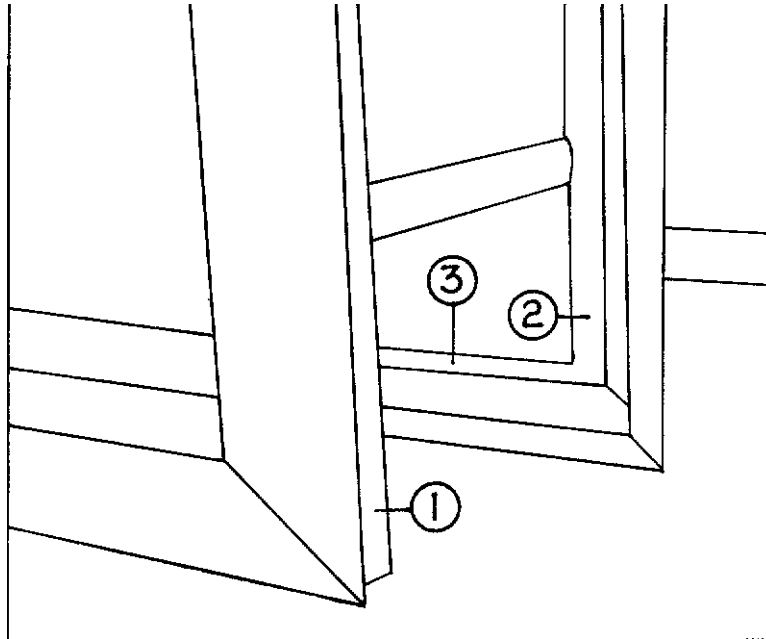

Lower rear corner, extended

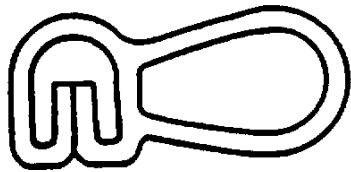

381594 Rubber extrusion  
bulb type, black

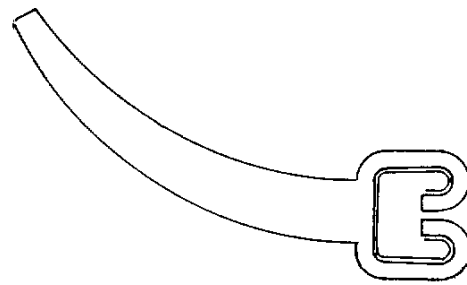

2 (381587 rubber extrusion,  
wiper) 1)



3) 381589 Rubber extrusion  
floor wiper



381663 Rubber extrusion, bulb  
w/tape (used on inside wall)

\*Note: Mounting brackets can be found in hardware.

# 2001 350/355 LAND YACHT XL

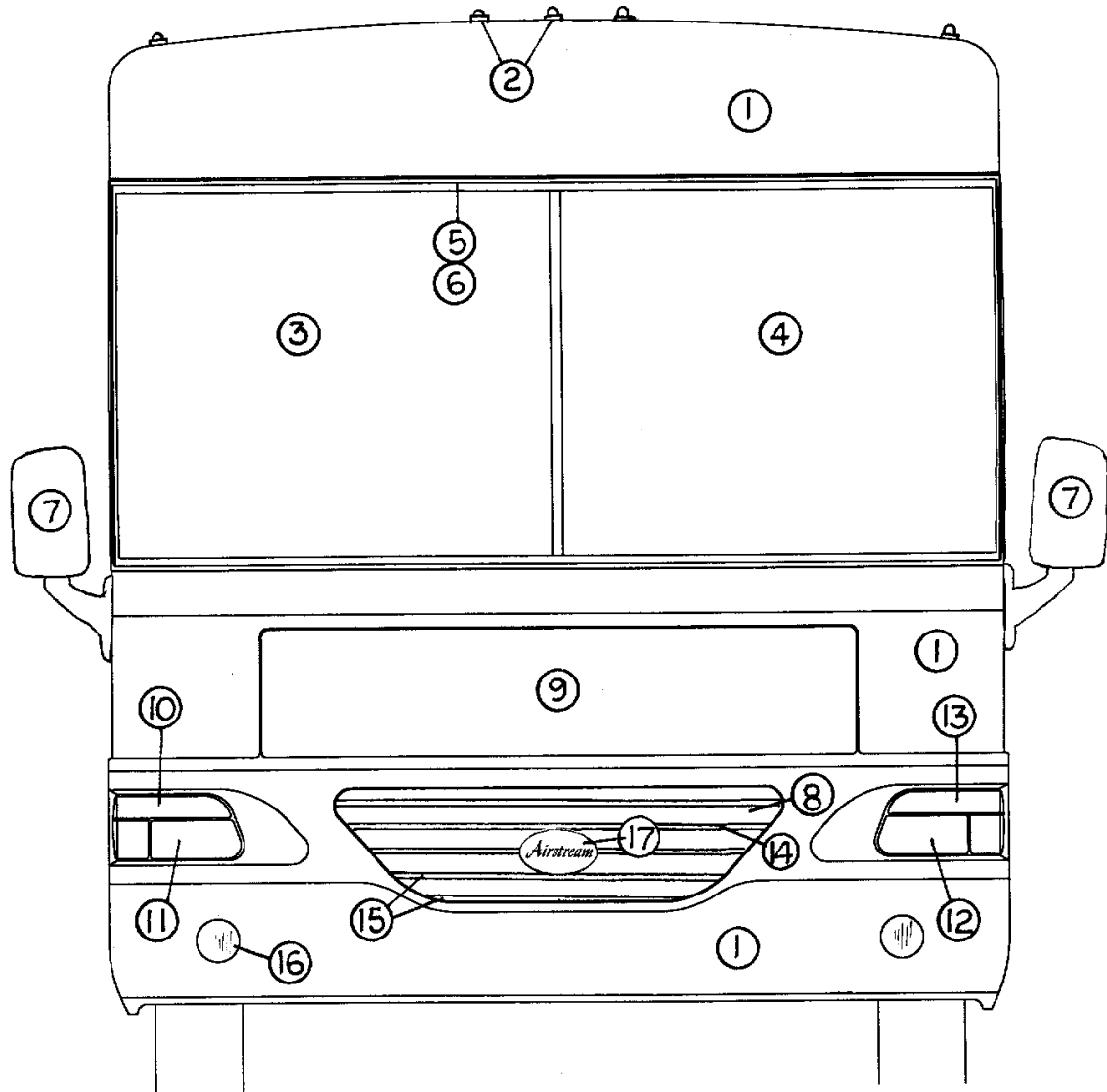



## 2001 350/355 LAND YACHT XL

### FRONT END

- 1) 203169 Front nose/cap, XL
- 2) 511400 Light clearance, tear drop, amber
- 3) 371370 Windshield, CS
- 4) 371369 Windshield, RS
- 5) 381640 Gasket, windshields (surrounds both sides)
- 6) 201260 Insert rubber, windshield gaskets
- 7) 511305-05 Mirror, Velvac#2025 w/remote, heated, pr.
- 8) 381642-01 Grill, front
- 9) 203173 Hood, fiberglass, white
- 10) 511398-02 Parking light/turn signal RH
- 11) 511397-02 Head light, RH
- 12) 511397-01 Head light, LH
- 13) 511398-01 Parking light/turn signal, LH
- 14) 453375 Screen, nose, top, perforated steel
- 15) 453376 Screen, nose, middle and bottom
- 16) 511514 Driving light, round, kit
- 17) 386043-03 Medallion "Airstream", black

# 2001 350/355 LAND YACHT XL

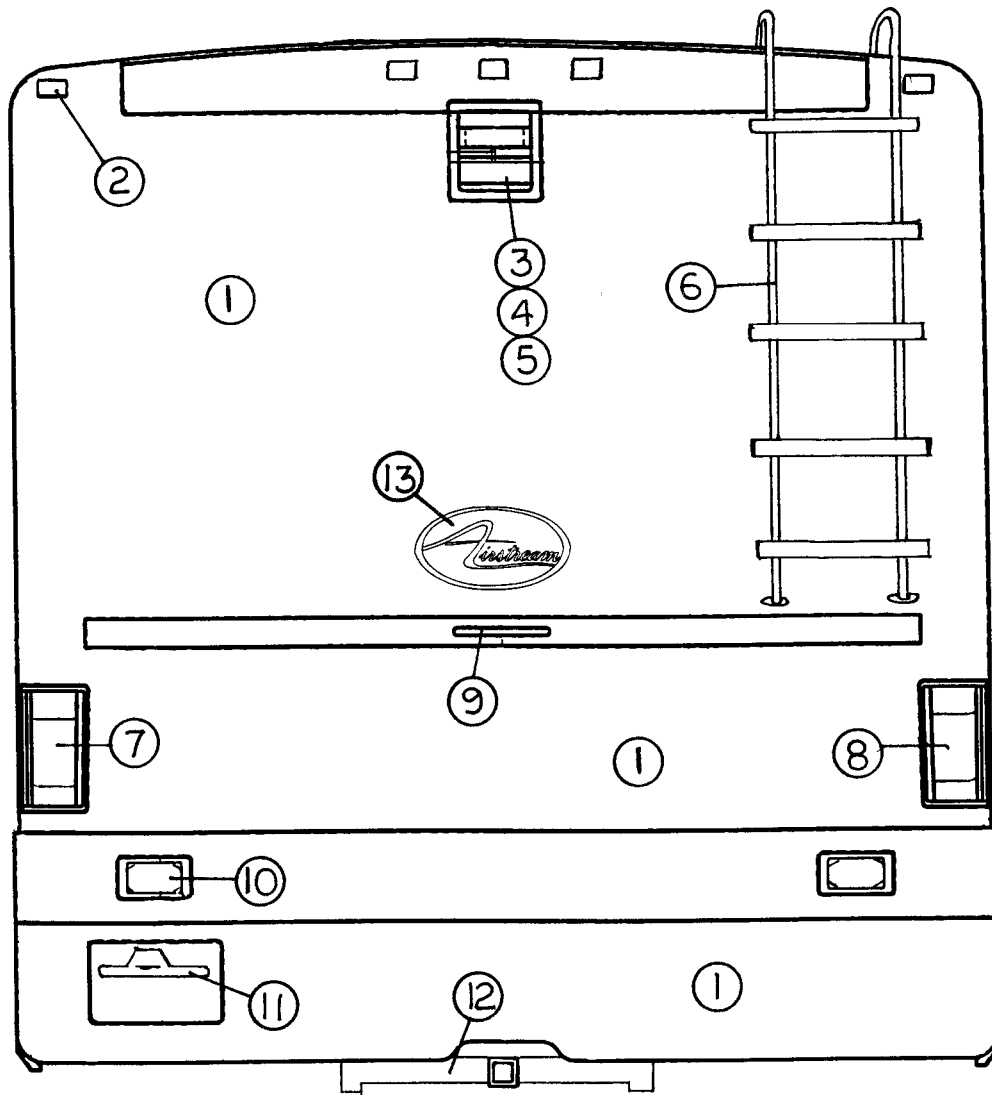

## 2001 350/355 LAND YACHT XL

### AFT END

- 1) 203170 Rear cap, XL
- 2) 510984-01 Light clearance, red
- 3) 510918-01 Monitor, Sony Watchman
- 4) 203181 Cover, back up camera
- 5) 511044-03 Actuator, two position, push/pull
- 6) 381639-01 Ladder, rear cap, 2pc(bottom not shown)
- 7) 511401-01 Tail light assembly, LH
- 8) 511401-02 Tail light assembly, RH
- 9) 511154-02 Light strip, 3rd brake
- 10) 511101-01 Docking light, stainless steel
- 11) 511407 License plate light w/holder
- 12) 400868-02 Hitch, Reese #38502
- 13) 386043-03 Medallion "Airstream", black

#### Not shown:

- 345388 Screw, #8 x 1.5 stainless steel, truss head  
(tail light mounting)

## 2001 350/355 LAND YACHT XL

### ROOF

203024	Fiberglass sheet, roof exterior, 106"wide
114619	Extrusion, roof corner cap
114570	Extrusion, awning rail
702482	Ceiling liner, Spectra Opal
800507-01	Paneling, luan, ceiling liner backing
201728-01	Extrusion, ceiling trim retainer
201728-04	Extrusion, ceiling trim
203609	Registers, ceiling vents

## 2001 350/355 LAND YACHT XL

### CHASSIS

410868-02	Reese hitch, XL Land Yacht
410825	Jack kit complete, Power Gear
453653	Bracket, L.P. tank, RH
453654	Bracket, L.P. tank, LH
410631	Winch assembly, spare tire
453295	Hanger, spare tire
511485	Step, double, electric
511486	Switch, magnetic, round, black, in doorjamb
511022-100	Motor, double step
511485-100	Control box, main, black
451811	Extender, tire valve, pr.
400924	Tire, Goodyear 245/70R 19.5 LRF
410828	Simulators, wheel, stainless steel, Ford
410828-01	8.5" Live stem valve extension, rear inner
203187-01	Mud flap w/logo RS
203187-02	Mud flap w/logo CS
410827	Pipe, fuel fill, 29"

## 2001 350/355 LAND YACHT XL

### CHASSIS

Acme  
(800-552-2263)

690382-01 Heater, air conditioner evaporator  
690408-01 Kit heater/ac accessory, w/Tarus control

60000283 Vacuum hose, 3/16"  
390382-08 Hose kit heater/ac, 99 Ford

### AUXILIARY HEATER

690311 Heater, auxiliary  
600247 Duct hose, 4"  
600678 Adaptor grill, 10" x 2"  
600969 Register 4" x 6", sand  
0310072 "Y" auxiliary heater hose connection

# 2001 350/355 LAND YACHT XL

## SECTION II D through E

### DASH

Dash parts ..... II-1

DECALS & MEDALLIONS ..... II-2

### DOORS/WINDOWS/AWNINGS

Roadside ..... II-5

Curbside ..... II-7

Main door & Screen Door ..... II-9

DRAPES/BLINDS/VALANCES..... II-10

### ELECTRICAL

110 volt ..... II-11

12 volt, chassis ..... II-13

12 Volt General ..... II-14

Dash switches/lens ..... II-17

12-volt interior switches ..... II-18

12-volt interior lights ..... II-18

12-volt exterior lights..... II-20

12-volt misc. .... II-21

Windshield wiper assy. .... II-23

### ENTERTAINMENT

Televisions ..... II-24

Radios ..... II-24

Rear view monitor ..... II-25





# 2001 350/355 LAND YACHT XL

## DASH

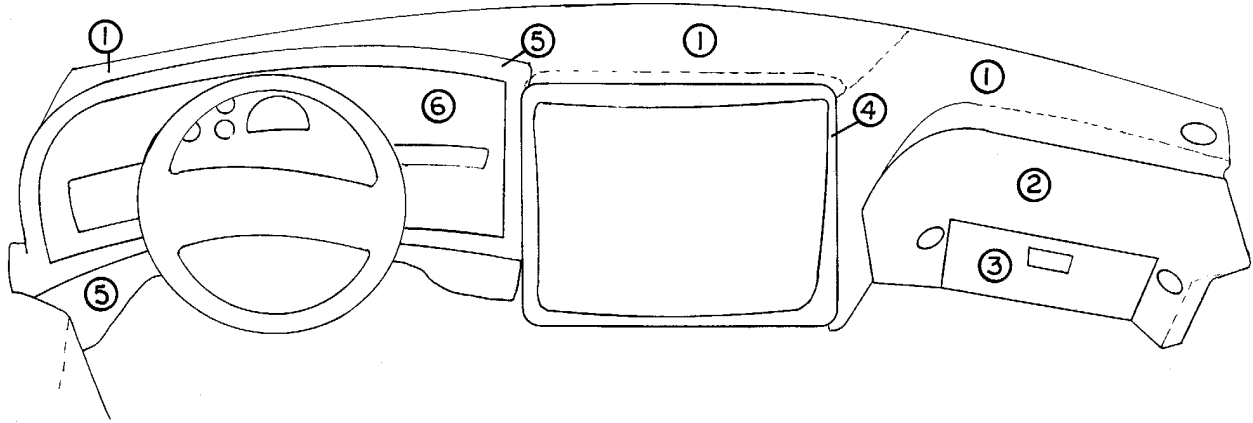

- 1) 203176 Dash, main, vinyl wrapped
- 2) 203193 Glove box module, wrapped
- 3) 203189 Door, glove box w/latch
- 4) 203177 Trim ring, TV, vinyl wrapped, RCA TV
- 203295 Trim ring, TV, vinyl wrapped, Sony TV
- 5) 203178 Trim ring, instrument panel
- 6) 203200 Panel, dash cluster, burl
  
- 203197 Cover, top, steering column (not shown)
- 386064 Medallion, dash, black, 3" (not shown)
- 453924 Bracket, TV dash, Sony TV

# 2001 350/355 LAND YACHT XL

## DECALS for reference only

There are no decals on the exterior of the 2001 350/355 XL Land Yacht.

Many places, especially the logos, will appear to be decals but are actually painted.

Each vehicle has been provided with a sheet listing the color codes on that particular motorhome. Also, each motorhome is shipped with touch-up paint for each color.

A back-up color chart for each motorhome is kept in Airstream's files. If calling Airstream for this information ask for "Sales" and have the serial number available for them.

## Medallions

386064-03	Black, 3", dash
386067-03	Anniversary, black, 4.375"
386063	Black, 8"

\*Paint color codes are provided with each unit and are also kept on record in the Airstream sales department.

2001 350/355 LAND YACHT XL

Notes

# 2001 350/355 LAND YACHT XL

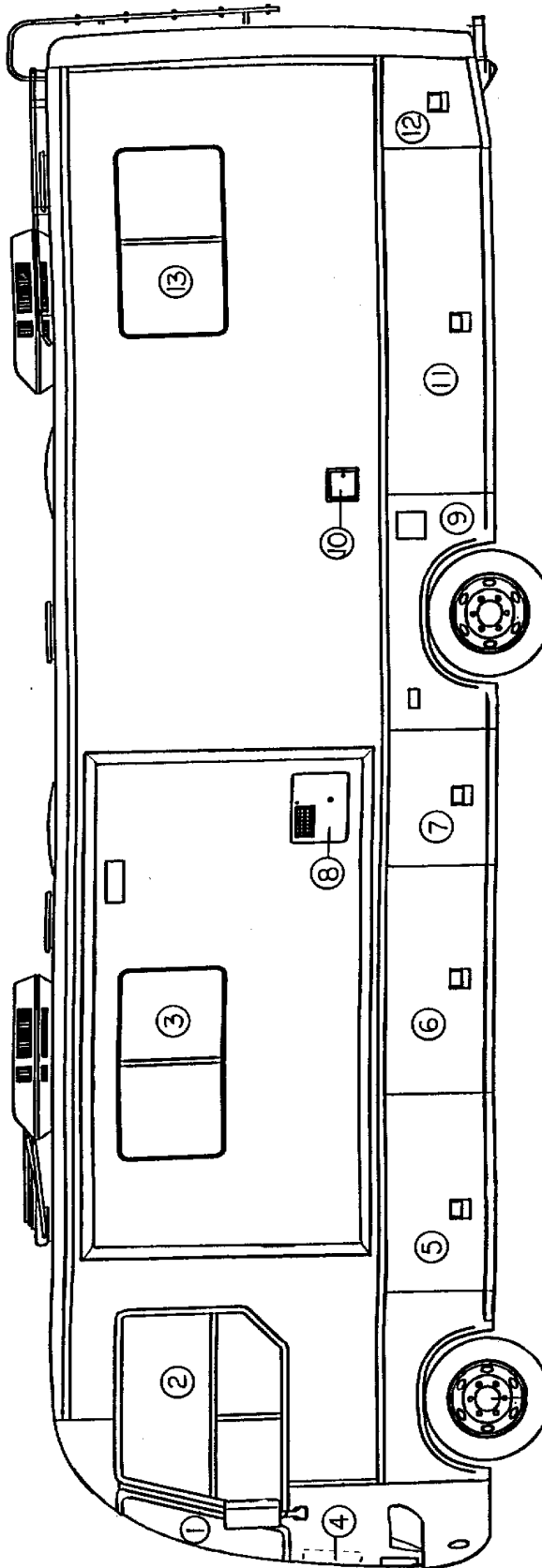

## 2001 350/355 LAND YACHT XL

### DOORS/WINDOWS-RS

- 1) 371369 Windshield, RS
- 2) 371365-01 Cab window, RS
- 3) 371366-25 Window, RS horizontal slide, 22" x 43"
- 4) 203173 Hood, fiberglass, white
- 5) 921189 Compartment door, 61.38"
- 6) 921189 Compartment door, 61.38"
- 7) 921188 Compartment door, 51.50"
- 8) 690259-05 Access door, water heater
- 8a) 690259-06 Flange, mounting, water heater
- 9) 381641 Door, fuel fill
- 10) 921178 Water fill, potable water
- 11) 921184-01 Compartment door, 63.88"
- 12) 921186 Compartment door, 34.00", angled
- 13) 371366-24 Window, RS, horiz. slide, egress, 26" x 43"

#### NOT SHOWN:

- 702949-03 Cover, galley slide out, Dometic  
702949-01 Hardware, galley slide out cover

2001 350/355 LAND YACHT XL

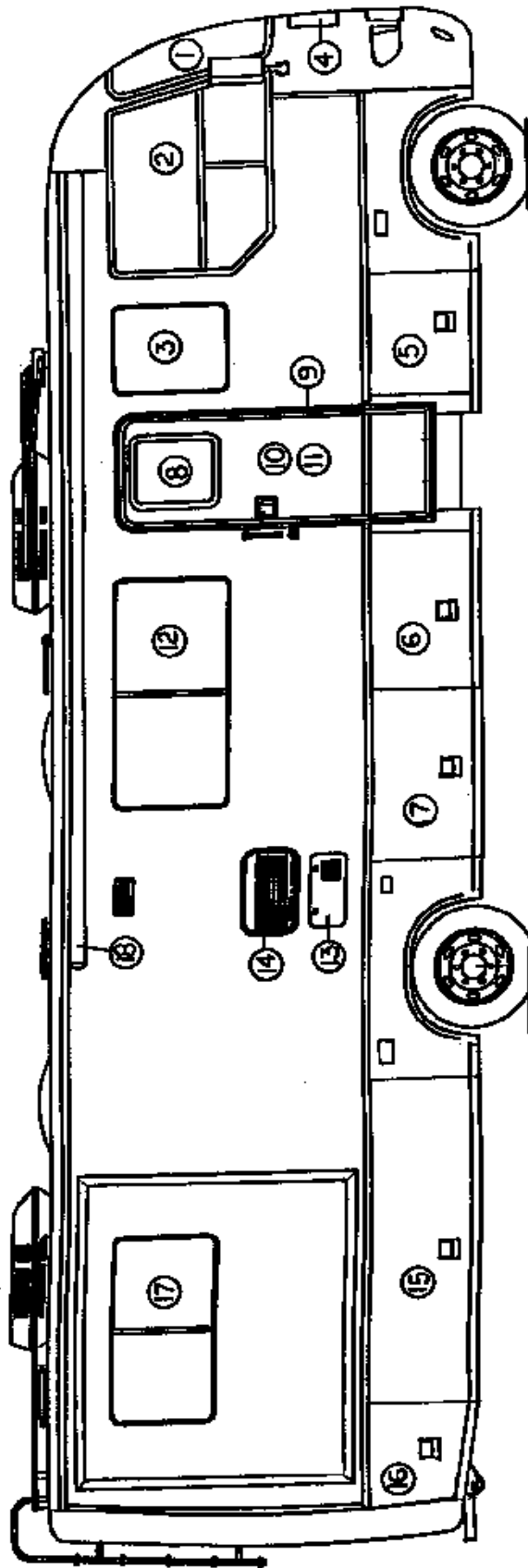

# 2001 350/355 LAND YACHT XL

## DOORS/WINDOWS

### CURBSIDE

- |                |  |
|----------------|--|
| 1) 371370      | Windshield, CS                             |
| 2) 371365-02   | Cab window, CS                             |
| 3) 371366-26   | Window, vertical slide, 26.0" x 21.50"     |
| 4) 203173      | Hood, fiberglass, white                    |
| 5) 921185      | Compartment door, 31.0"                    |
| 6) 921183      | Compartment door, 51.5"                    |
| 7) 921183      | Compartment door, 51.5"                    |
| 8) 371366-01   | Window, stationary, 19.25" x 23.25         |
| 9) 922500      | Jamb, main door                            |
| *10) 110581    | Main door assembly                         |
| *11) 922503    | Screen door                                |
| 12) 371366-23  | Window, horizontal slide, 26" x 43"        |
| 13) 690274-05  | Door, Hydroflame, exterior                 |
| 14) 690340-03  | Refrigerator door, flush mount             |
| 15) 921184-01  | Compartment door, 63.88"                   |
| 16) 921187     | Compartment door, 34.0", angled            |
| 17) 371366-23  | Window, horizontal slide, 26" x 43.0"      |
| 18) 702679-34  | Awning, patio, 17', Sapphire Blue          |
| 18a) 702679-11 | Hardware, patio awning, tall, satin finish |

### NOT SHOWN:

- |           |                                   |
|-----------|-----------------------------------|
| 702949-02 | Cover, bedroom slide out, Dometic |
| 702949-01 | Hardware, bedroom slide out cover |

\* More detail can be found on following pages.

# 2001 350/355 LAND YACHT XL

## MAIN and SCREEN DOOR

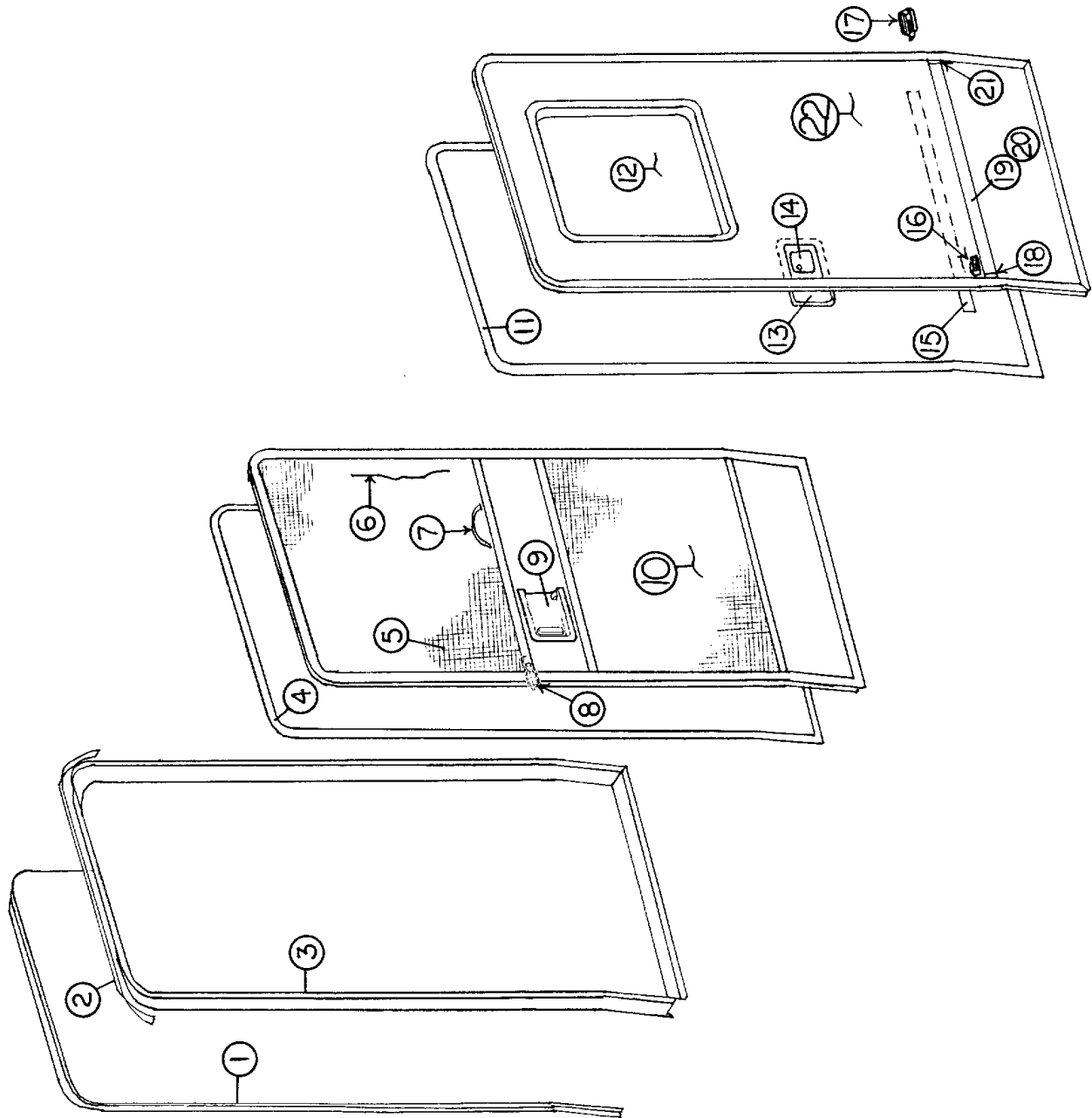



## 2001 350/355 LAND YACHT XL

### MAIN and SCREEN DOOR

- 1) 114884 Trim, inside doorjamb
- 2) 114059 Drip cap, main door
- 3) 922500 Jamb, main door
- 4) 365013-01 Gasket, screen door, low-density foam
- 5) 380079 Screen, plastic mesh
- 6) 200518 Spline, gray, round, screen installation
- 7) 380004 Pull handle, screen door w/screws
- 8) 381454 Latch, screen door, double action, Bullet
- 9) 203000 Closeout , plastic, sliding, screen door, (gizzy)
- 10) 922503 Screen door assembly
- 11) 365045 Seal, main door
- 12) 371366-01 Window, double pane, stationary, 19.25 x 23.25
- 13) 203002 Cover, inner door lock pocket, plastic
- 14) Door lock--the main door lock is made up of five separate parts- see hardware in Section III for listing
- 15) 114005 Trim, inside door face(also used as roof trim)
- 16) 201056 Catch, main door hold back
- 17a) 380291 Main door hold back, used w/housing 380290
- 17b) 380290 Latch housing, main door hold back
- 18) 114914-02 End cap, rub rail, LH
- 19) 114865 Extrusion, rub rail
- 20) 114865 is painted
- 21) 114914-01 End cap, rub rail, RH
- 22) 110581 Main door assembly

## 2001 350/355 LAND YACHT XL

### DRAPES/BLINDS/VALANCES

964117-01	Valance, galley 29' w/26.25 leg
964792-02	Valance, large, bedroom
964786-01	Valance, small, CS lounge
964792-01	Valance, large, living room
964730-02	Shadow box assy., bedroom area
964731-01	Shadow box assy., lounge CS,
964732-01	Shadow box assy., lounge, RS
964730-01	Shadow box assy., dinette/lounge area
702969-29	Shade, pleated, night, 45.00" x 29"
702968-29	Shade, pleated, day/night, 45.00" x 29
702968-30	Shade, pleated, day/night, 45.00" x 25
702968-31	Shade, pleated, day/night, 23.50" x 29
702968-33	Shade, pleated, day/night, 60.25" x 27"
702952	Blind, galley cover
702951	Windshield wrap curtain w/track & strap
964746	Stop, front windshield wrap, Oak, 3.5" x 43.0"

## 2001 350/355 LAND YACHT XL

### ELECTRICAL

#### 110 VOLT

510634	Power cord, 36ft.
511426	Converter, electronic, 55 amp
511336	Breaker box, Square D, 30-amp
510663	Breaker, 30-amp
510662	Breaker, double pole, 20/20
510661	Breaker, 20-amp, GFI
511444	Transfer switch, 2-30 amp
510606	Priority switch and box-front/rear air conditioner
500563	Receptacle, 15-amp, ivory
511451-02	Receptacle, 20-amp, single, brown
511451-01	Receptacle, 20-amp, single, white
510888-05	Outlet w/cover, white, GFI
500785	Outlet, duplex, brown
510676-01	Outlet, exterior, gray
510817-01	Box, outlet, weather proof, single
511260	Cover, weather proof, single
511023	Tester, circuit analyzer (loose item)
511278	Lock out, 110 volt disconnect, front TV
511038	Generator, Onan, 5.0 Marquis
0450735	Hour meter, generator
511443	Cord, portable service (used on slide out)

# 2001 350/355 LAND YACHT XL

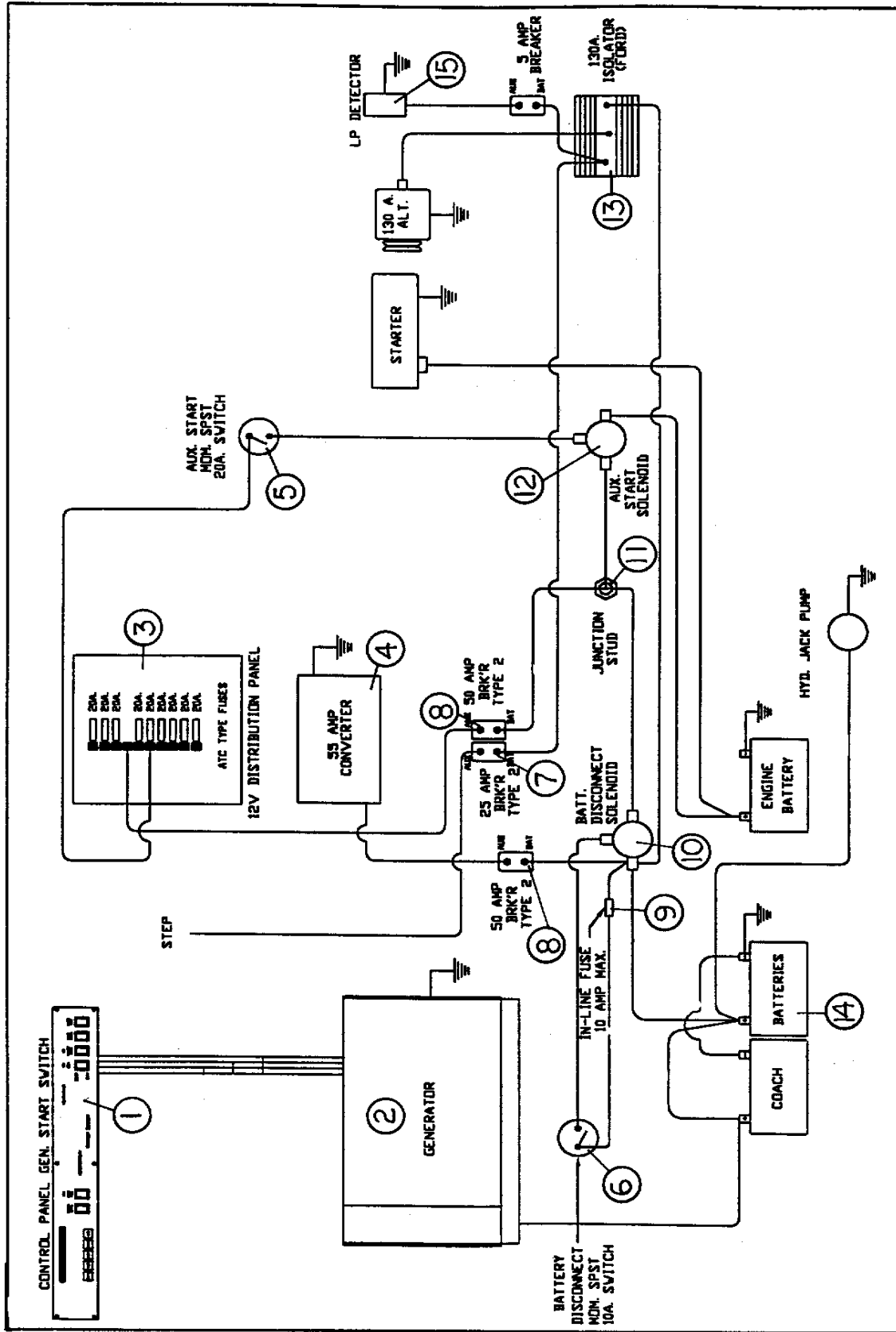

## 2001 350/355 LAND YACHT XL

### \*ELECTRICAL 12 VOLT-CHASSIS

- |               |   |
|---------------|---|
| 1) 511446     | Monitor panel   |
| 2) 511038     | Generator, Onan Marquis, 5.0  |
| 3) 511016     | Fuse block, 12 volt, 9 position, ATC type                                 |
| 4) 511426     | Converter, electronic, 55 amp   |
| 5) 510929-02  | Switch, auxiliary start, momentary, SPST                                  |
| 6) 962203     | Battery disconnect switch (part of four gang switch cluster at main door) |
| 7) 510947-25  | Breaker, 12 volt DC, 25 amp, w/ears                                       |
| 8) 500475-50  | Breaker, 12 volt DC, 50 amp   |
| 9) 511392     | Fuse holder, in-line, 15 amp  |
| 10) 511351    | Solenoid, latching, cont. duty, kill switch                               |
| 11) 511090    | Junction block, stud type   |
| 12) 511199    | Solenoid, continuous duty, aux. start                                     |
| 13) 510642-01 | Isolator, 130 amp   |
| 14) 511132    | Battery, deep cycle   |
| 15) 511309    | Detector, LPG   |
| 511001        | Switch/safety, battery disconnect, ST-9                                   |
| 511002        | Switch, safety, battery disconnect, T-MB                                  |

\*See ENTERTAINMENT section for radio, VCR, TV, antennas etc.

# 2001 350/355 LAND YACHT XL

## ELECTRICAL

### 12 VOLT-GENERAL

511132	Battery, deep cycle
511016	Fuse block, 12 volt, 9 position, ATC type
510947-20	Breaker, 12 volt, automatic, type II-20amp
510947-30	Breaker, 12 volt, automatic, type II-30amp
510947-50	Breaker, 12 volt, automatic, type II-50amp
510947-25	Breaker, 12 volt, automatic, type II-25amp
510947-05	Breaker, 12 volt, automatic, type II-5amp
500475-50	Breaker, 12 volt, 50amp w/mounting ears
500475-30	Breaker, 12 volt, 30amp w/mounting ears
500475-05	Breaker, 12 volt, 5amp, w/mounting ears
500917-01	Breaker, 80 amp, Klixon
511392	Fuse holder, 15amp, in-line
510328	AGC fuse, 10amp
500773-01	ATC fuse, 1amp (LP detector)
510596	Cigarette lighter
510807	Outlet, 12-volt, lighter receptacle
511276	Cover, 12-volt outlet, black
511229	Sending unit, 90ohm, LP tank

# 2001 350/355 LAND YACHT XL

## 12VOLT-DASH SWITCH & LENS

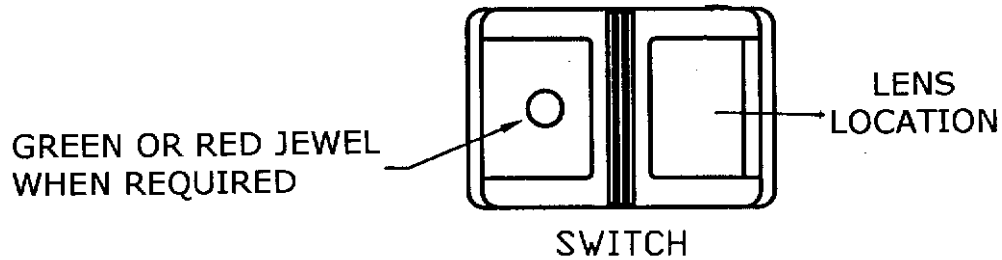

510929-04	Switch, rear heat
510929-06	Switch, TV speaker, SPST
510929-02	Switch, auxiliary start, ICC blink, momentary, SPST
510929-08	Switch, rear camera, momentary, DPDT
510929-05	Switch, driving light, aisle light, defrost fan, On-Off, SPST
510929-07	Switch, docking light, inverter, On-Off with red Indicator light, SPST
510930-01	Lens, ICC blink
510930-02	Lens, door lock
510930-06	Lens, aisle light
510930-33	Lens, auxiliary start
510930-25	Lens, rear camera
510930-07	Lens, docking light
510930-31	Lens, TV speaker
510930-35	Lens, defrost fan
510930-29	Lens, map light
510930-04	Lens, rear heat
511305-10	Switch, remote exterior mirror
511486	Switch, magnetic, black, at door

## 2001 350/355 LAND YACHT XL

### 12 VOLT-INTERIOR SWITCHES

511327	Switch body w/rocker, single
511328	Switch cover, printed white
511445	Switch, closet light, white
511530-01	Switch, SPST white, shower light
511530-02	Bezel, white, shower light switch
510868	Switch, 4 gang, bezel
500933	Switch, water heater
511040	Switch, door, momentary, normally on
962203-01	Switch cluster, main door
511513	Light, green, LED, monitors battery disconnect
511078	Switch body, illuminated
511083-02	Cover, switch, 3&4 gang
511445	Switch, closet light white
511474-02	Switch, remote, dimmer, black
520316	Switch, remote, slide out

### 12 VOLT-INTERIOR LIGHTS

500960-02	Light, fluorescent, recessed, 20.63"
680085	Bulb, fluorescent, #F8T5-CW
500960-01	Light, fluorescent, recessed, 14.75"
680084	Bulb, fluorescent, #F8T5-CW
511298	Wall lamp, 12 volt, rectangular
511298-01	Shade, wall lamp, rectangular
510689	Bulb, incandescent, #1076
511467-01	Wall lamp, swing arm, brass
511467-02	Lampshade, round
510689	Bulb, incandescent, #1076



# 2001 350/355 LAND YACHT XL

## ELECTRICAL

### 12 VOLT-INTERIOR LIGHTS

511248 50085-02	Light, incandescent single, square Bulb incandescent, #1141
500842 680084	Light, fluorescent, 12"x5.5"x1" Bulb, fluorescent, F8T5-CW
511422 511137-100	Light, map, halogen, white Bulb, 12 volt, JC-10, wedge base
511422 01 511137-100	Light, map, halogen, black Bulb, 12 volt, JC-10, wedge base
511410 50085-02	Light, shower, incandescent Bulb, incandescent, #1141
511417 510689	Wall light, Demi-sconce, slide out Bulb, incandescent, #1076
511454 680085	Light, fluorescent, 15, watt Bulb, fluorescent, F15T8-CW
511387 50085-02	Light, Acrylic Tiffany, galley Bulb, incandescent, #1141

## 2001 350/355 LAND YACHT XL

### LIGHTS-EXTERIOR

511397-01	Headlamp, RS, Ford Explorer
511397-02	Headlamp, CS, Ford Explorer
511398-01	Park lamp, RS, Ford Explorer
511398-02	Park lamp, CS, Ford Explorer
511514	Driving light kit, halogen, round
511401-01	Tail lamp, RS, Ford #7452RV
511401-02	Tail lamp, CS, Ford #7453RV
511154-02	Light strip, 3rd brake 1" x 10"
511407	License plate holder w/light
510984-01	Light, clearance/side marker, red
511250-02	Light, side marker, amber
381396	Gasket, clearance light/side marker
511400	Light, marker, teardrop, amber
511101-01	Docking light , halogen w/s.s. bezel
201991	Housing, docking light
510672	Porch light, white
510732	Utility light #1327

## 2001 350/355 LAND YACHT XL

### 12 VOLT-MISC. EQUIPMENT

511305-05	Mirrors, exterior, Velvac w/remote, heated, pr.
511305-10	Switch, remote, heated mirrors
510807	Outlet, cigarette lighter
510596	Cigarette lighter, 12-volt
511446	Monitor panel
511162-01	Keyless entry w/remote(opt)
511162-02	Transmitter, 4 channel
510802-01	Actuator, door lock, 5 wire
511141	Solar panel, 5 watt
511413	Light, solar panel
510781	Detector, smoke
511309	Detector, LPG
511343	Detector, carbon monoxide
510843	Flasher, heavy duty
510844-01	Relay, Bosch, slide out room
520316	Switch, slide out room
510734	Alarm, back-up
510796	Buzzer, head light warning

# 2001 350/355 LAND YACHT XL

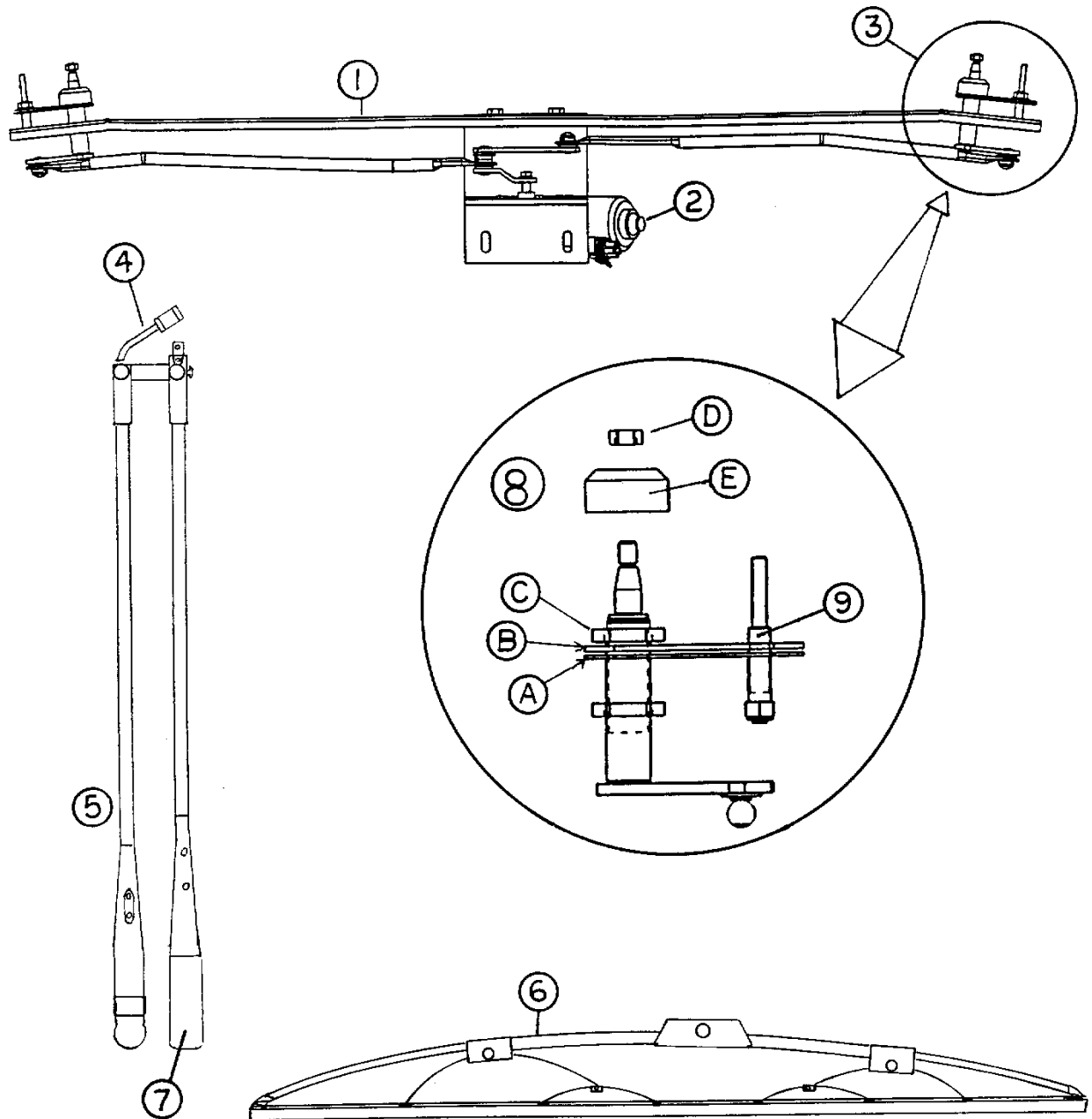

# 2001 350/355 LAND YACHT XL

## ELECTRICAL

### WINDSHIELD WIPER

- |                |                                       |
|----------------|---------------------------------------|
| 1) 511440      | Windshield wiper assy, XL             |
| 2) 511440-100  | Wiper motor, Ford/Freightliner        |
| 3) 511440-102  | Pivot and link assembly, Trico        |
| 4) 511419-103  | Washer jet and tubing, Trico          |
| 5) 511419-104  | Pantograph arm assembly, Trico        |
| 6) 511419-105  | Blade assembly, 28", Trico            |
| 7) 511419-106  | Head cover, main arm, black, Trico    |
| 8) 511440-107  | Hardware kit, includes the following: |
| a) gasket      |                                       |
| b) face plate  |                                       |
| c) thin nut    |                                       |
| d) 8 mm nut    |                                       |
| e) rain shield |                                       |

## 2001 350/355 LAND YACHT XL

### ENTERTAINMENT

510788-01	Antenna, TV, Winegard
510788-03	Amplifier, TV antenna
500976	Outlet, TV jack
500996	Jack, TV/phone, gray
511375-01	Jack, modular telephone, ivory
500994	Antenna, radio
511458	Antenna, side mount, CB
690419	TV, Sony, 20"
203177	Trim ring, TV, front
511373-01	Theatre sound system, 2-18 watt amplifiers (puts TV through front speakers)
511442	Radio w/CD player CDX-C5300MR04
511048	Speaker, Coustic, #HS-402
511048-01	Grill, speaker, Coustic, white
511385-02	Amplifier module, Theater sound system
511385-03	Cube speakers, w/bracket, black
511385-04	Speaker, 6"x9", Theater sound
511385-05	Grill, for 6"x9" speaker
500974	Speaker/headphone system, opt.
500975	Headphones, lightweight, opt.
511423	Plug-earphone, opt.
511488-01	Mobile theater sound system, Sony, opt.
511383-02	Remote control, Sony, wireless, option.
511191	CD changer, 10 disc, Sony CDX-715, option.
511310	Video control center
114909-01	Bracket, TV mount, bedroom, RH
114909-02	Bracket, TV mount, bedroom, LH
381644	Swivel, TV
381664-02	Strap, safety, 1"black
381664-01	Thumb lock, safety strap, black

## 2001 350/355 LAND YACHT XL

### ENTERTAINMENT

510918-01 Monitor, Sony Watchman  
510929-08 Switch, momentary, rear camera  
511044-03 Actuator, two position, rear camera  
203181 Cover, back up monitor

### BEGINNING UNIT 810740

511464-07 Dual speaker/headphone system, bedroom  
511464-05 Control, headphone/dual speaker system  
511464-06 Harness, headphone/dual speaker system  
511464-02 Speaker, 4", 5 watt, headphone/dual speaker  
system  
511464 -03 Grill, speaker, headphone/dual speaker  
system  
  
690436-01 TV, front, 20" stereo, Sony,  
MDL KV-20FS12MT02  
690436-02 TV, rear, 20", stereo, Sony MDL KV-  
20FS12MT12 (has adapter for dual  
headphone system)





# 2001 350/355 LAND YACHT XL

## SECTION III F through H

FASTENERS (common fasteners available locally are not listed)

Rivets.....	III-1
Screws .....	III-3

### FLOOR COVERING

Carpet .....	III-4
Hardwood flooring .....	III-4
Tile .....	III-4
Mats.....	III-4

### FURNITURE

Interior doors .....	III-5
Mirrors.....	III-6
Drawer face.....	III-7
Drawer box .....	III-7
Bedroom furniture w/slide .....	III-8
Bedroom furniture non slide .....	III-10
Bath area .....	III-12
Galley, slide out .....	III-13
Cab and lounge, slide out .....	III-15

### HARDWARE

Exterior locks.....	III-17
Main door/screen door .....	III-18
Exterior lower compartment .....	III-20
Slide out room .....	III-23
Awning hardware .....	III-25
Interior hardware .....	III-26



# 2001 350/355 LAND YACHT XL

## \*FASTENERS



330126-02  
rivet, pop  
dia. 1/8 "  
grip range .126-.187  
stainless steel body  
stainless steel mandrel

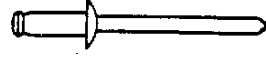

330126-03  
rivet, pop  
dia. 1/8 "  
grip range .126-.250  
stainless steel body  
stainless steel mandrel

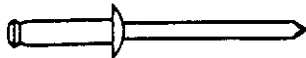

330136-04  
rivet, pop  
dia. 1/8"  
grip range .313-.375  
stainless steel body  
stainless steel mandrel



330031-03  
rivet, pop  
dia. 3/16"  
grip range .125-.250  
stainless steel body  
stainless steel mandrel



330031-03  
rivet, pop  
dia. 3/16"  
grip range .126-.250  
stainless steel body  
steel mandrel



320108-01  
rivet, bulb tite, w/washer  
dia. 3/16"  
grip range .050-.187  
aluminum body  
aluminum mandrel

\*Common bolts and screws readily available at local hardware outlets have not been listed.

# 2001 350/355 LAND YACHT XL

## \*FASTENERS

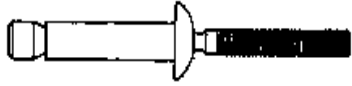

330139-02  
dia. 1/4"  
grip range .350-.625  
stainless steel body  
stainless steel mandrel



330139-01  
dia. 1/4"  
grip range .080-.375  
stainless steel body  
stainless steel mandrel

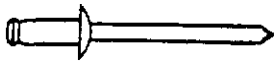

330127-03  
dia. 1/8"  
grip range .063-.125  
aluminum body  
aluminum mandrel



300101  
1/8" I.D.  
washer, aluminum

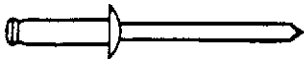

330127-05  
dia. 1/8"  
grip range .251-.312  
aluminum body  
aluminum mandrel



330137  
dia. 1/8"  
grip range .039-.189  
aluminum body  
steel mandrel

\*Common bolts and screws available at local hardware outlets have not been listed.

# 2001 350/355 LAND YACHT XL

## \*FASTENERS



320122  
screw, pan head, Phillips  
black  
#4 x 1/8" (glove box tray)



320114-04  
screw wood oval head, Phillips  
antique brass  
#5 x 1/2"



320114-05  
screw wood, oval head, Phillips  
antique brass  
#5x5/8"



320115-06  
screw wood, flat head, Phillips  
stainless steel  
#6x1.00"



320124-06  
screw, flathead, Phillips  
stainless w/white head

\*Common bolts and screws readily available at local hardware outlets have not been listed.

## 2001 350/355 LAND YACHT XL FLOOR COVERING

702793-07*	Carpet, Regal/Shadow, Roman Sands
700173-01	Carpet padding, 1/2"
701538	Carpet, Velour gray, storage compartments
201709-02	Extrusion, trim molding, black, baggage com.
702550	Matt, entrance, step well
702549	Matt, entrance, w/Airstream logo
702812-02	Step, tread, round, black
702893	Step tread, smooth rubber
702963	Vinyl, embossed, threshold, 1.75" wide
801115	Flooring, white Oak 3/8"
800639-02	Adhesive, Oak plank
360216	Acrylic latex caulk, brown
114724	Trim, carpet, Z bar
702903-06	Tile, 12 x 12, KPT/Moraco
702903-07	Grout-Ivory #39
702903-08	Schluter strip

\*See sample chart provided to your sales department for more carpet and upholstery part numbers.

## 2001 350/355 LAND YACHT XL

### FURNITURE DOORS-INTERIOR

800597-724	Door, raised panel	8.75" x 20.25"
800597-574	Door, raised panel	9.00" x 16.25"
800597-644	Door, raised panel	10.50" x 20.00"
800597-014	Door, raised panel	10.50" x 22.00"
800597-124	Door, raised panel	10.50" x 26.25"
800597-544	Door, raised panel	10.75" x 14.50"
800597-094	Door, raised panel	11.00" x 29.75"
800597-594	Door, raised panel	11.50" x 18.50"
800597-274	Door, raised panel	11.50" x 25.0"
800597-064	Door, raised panel	12.25" x 16.00"
800597-734	Door, raised panel	13.25" x 11.00"
800597-444	Door, raised panel	13.75" x 29.75"
800597-524	Door, raised panel	18.00" x 29.50"
801157-12	Door, raised panel, smooth	11.25" x 31.00"

### MISCELLANEOUS DOORS

381643	Door, sliding, rear	61" x 69.5"
800557-304	Door frame only (for mirror)	
800557-154	Door frame only (for mirror)	
801225-01	Door panel, refrigerator, upper, Oak	
801225-03	Door panel, refrigerator, lower, Oak	
964689	Bath door, hinged	
964694	Door, forward bath slider,	28.5" x 71"
702941	Shower door, gold, Aqua glass	
800881-144	Door louvered, Oak,	33.5" x 12.00"
371374-01	Glass, tinted, 9.88" x 21.57",	front roof locker
371375-01	Glass, tinted, 8.38" x 20.93",	front roof locker

# 2001 350/355 LAND YACHT XL

## FURNITURE

### MIRRORS

		Height x width (inches)
372210-12	Mirror, beveled four sides	6.00 x 22.00
372210-13	Mirror, beveled four sides	6.00 x 41.50
372210-03	Mirror, beveled	8.88 x39.12
372211-04	Mirror beveled three sides	11.00 x 16.75
372211-02	Mirror, beveled three sides	14.00 x 16.75
372211-01	Mirror, beveled three sides	15.25 x 16.75
372212-01	Mirror, beveled	12.25 x25.00
372262-15	Mirror, safety glass	10.56 x 17.12
372203-10	Mirror, safety glass	11.00 x 29.00
372203-19	Mirror, safety glass	11.13 x 22.50
372203-18	Mirror, safety glass	11.13 x 28.13
372203-04	Mirror, safety glass	14.00 x 36.00
372262-10	Mirror, safety glass	16.12 x 28.12
372203-13	Mirror, safety glass	16.25 x 29.00
372262-67	Mirror, safety glass	20.00 x 27.50
372262-66	Mirror, safety glass	31.00 x 66.88
372207-02	Mirror, bronze	28.00 x 60.00



# 2001 350/355 LAND YACHT XL

## DRAWER FACES

		Height x Width (inches)
800599-584	Drawer face	4.75 x 21.50
800599-644	Drawer face	5.75 x 23.63
800599-024	Drawer face	7.00 x 11.75
800599-514	Drawer face	7.00 x 19.00
800599-384	Drawer face	7.00 x 21.50
800599-634	Drawer face (pantry)	7.75 x 60.75
800599-654	Drawer face	8.00 x 10.50
800599-664	Drawer face	8.00 x 14.25
800599-234	Drawer face	8.00 x 21.50
800599-274	Drawer face	10.50 x 23.63
800599-294	Drawer face	11.75 x 21.50
800599-674	Drawer face	12.00 x 14.25

## DRAWER BOXES

		(Inches) Height x width x depth
964906-02	Drawer box	2.75 x 19.50 x 18.00
964906-14	Drawer box	2.75 x 21.63 x 18.00
964910-02	Drawer box	5.00 x 10.00 x 18.00
964910-17	Drawer box	5.00 x 11.75 x 22.00
964910-18	Drawer box	5.00 x 17.00 x 14.00
964910-06	Drawer box	5.00 x 19.50 x 14.00
964907-02	Drawer box	6.00 x 8.50 x 18.00
964907-04	Drawer box	6.00 x 12.25 x 18.00
964907-03	Drawer box	6.00 x 19.50 x 18.00
964908-05	Drawer box	8.00 x 21.62 x 18.00
964909-01	Drawer box	8.50 x 18.00 x 10.00
964909-02	Drawer box	10.00 x 19.50 x 18.00
964909-03	Drawer box	10.00 x 12.25 x 18.00
964008	Lounge drawer box	
963749	Drawer box, double bed	
961759	Drawer box, double bed	

# 2001 350/355 LAND YACHT XL

## FURNITURE

### REAR BEDROOM W/SLIDE OUT

964712	Night stand assembly, LH
964664	Face frame, LH nightstand
964710	Top, LH nightstand
964713	Night stand assembly, RH
964664	Face frame, RH nightstand
964711	Top, RH nightstand
964798	Bed assembly
964719	Top, bed assembly
964759	Headboard, 60.25"
381067-07	Spring, gas prop, 90#
381262	Bracket, prop w/ball, angle
381263	Bracket, prop w/ball, straight
381085	Clip, retaining, gas prop
964750-01	TV cabinet assembly
964749-01	Face frame, rear TV cabinet
964692	Top, rear TV cabinet
964683	Breaker box cabinet (upper rear corner)
964641-01	Face frame, breaker box cabinet
964681	Wardrobe assembly, rear
964649	Face frame, rear wardrobe
381643	Sliding door, rear wardrobe

(continued)

# 2001 350/355 LAND YACHT XL

## FURNITURE

### REAR BEDROOM W/SLIDE OUT

964680	Bed assembly "S"
964719	Top, bed assembly "S"
964725	Corner cabinet assembly
964723	Face frame, corner cabinet, overhead
964749-01	Face frame, TV cabinet, bedroom
964749-02	Face frame, TV cabinet, bedroom
964755	Face frame, bedroom credenza, RH
964758	Face frame, bedroom credenza, LH
964756	Credenza assembly, bedroom
964757	Top, bedroom assembly
964682	TV cabinet assembly, bedroom, "S"
964750-02	TV cabinet assembly, bedroom, "B"

## 2001 350/355 LAND YACHT XL

### REAR BEDROOM-NON-SLIDE

350-J

964838-01	Wardrobe assembly, rear, RS "J"
964428	Face frame, RS rear wardrobe
964868	Control panel assembly (furniture part only)
964869	Face frame, control panel
386017	Decal, black, control panel backer
964838-02	Wardrobe assembly, rear, CS, "J"
964428	Face frame, CS rear wardrobe
964872	Roof locker, rear
964873	Face frame, rear roof locker
381449-05	Post, decorative rail, brass
381449-04	Rail, decorative rail, 30"
964833	Bed assembly "J"
964797	Bed top
964759	Head board, 60.25"
964875	TV/dresser cabinet assembly
964876	Face frame, TV/dresser cabinet
964882	TV face frame
964844	Wardrobe assembly, RS
964845	Face frame, RS wardrobe

# 2001 350/355 LAND YACHT XL

## FURNITURE

### REAR BEDROOM-NON-SLIDE

#### 350-"B"

964681-01	Wardrobe assembly, rear
964649-01	Face frame, rear wardrobe assembly
964798	Bed assembly
964797	Top, rear bed
964759	Headboard, 60.25"
964804	Nightstand assembly, LH
964809	Face frame, nightstand assembly, LH
964810	Top, LH nightstand assembly
964805	Nightstand assembly, RH
964812	Face frame, RH nightstand
964811	Top, RH nightstand
964724	Corner cabinet, bedroom
964722	Face frame, corner bedroom cabinet
962666	Top, make-up cabinet
964725-01	Corner cabinet, overhead, bedroom
964723-01	Face frame, overhead corner cabinet
964816	Roof locker assembly, bedroom
964817	Face frame, bedroom roof locker
964750-02	TV cabinet assembly, bedroom
964749-02	Face frame, bedroom TV cabinet
964868	Control panel assembly, bedroom(furniture only)
964869	Face frame, bedroom control panel
386017	Decal, black, control panel backer

## 2001 350/355 LAND YACHT XL

### FURNITURE BATH AREA

964667	Roof locker, lavatory
964659	Face frame, lavatory roof locker
964660	Lavy cabinet assembly
964647	Face frame, lavy cabinet
965225-01	Lavy top, bisque
702942	Laundry bag
964666	Linen cabinet
964650	Face frame, linen cabinet
964956	Medicine cabinet
964955-004	Face frame, medicine cabinet
964689	Bath door, hinged
964652	Jamb, angled, bath door
961410-01	Jamb, bath door
964686	Header, bath door
964690	Control panel assembly
964687	Face frame, control panel
961836	Magazine rack
800911-02	Rail, decorative Oak
381660	Dome plug, 3", black-clean out access
702941	Shower door
203180-01	Shower stall--reference only - repair in place
703053	Border, wallpaper, all but Vintage Leaf
702961	Border, wallpaper, Vintage Leaf only

\*Bath fixtures may be found in hardware--if connected to drains or water look in plumbing.

## 2001 350/355 LAND YACHT XL

### GALLEY AREA W/SLIDE OUT

964971	Galley assembly, cook top section
964957-004	Face frame, galley cook top section
964970	Galley assembly, drawer module
964958-004	Face frame, galley drawer module
964669-01	Galley assembly, sink section
964643	Face frame, galley sink section
964673-02	Top, galley, Corian
964383-01	Range covers
601633-06	Sink, porcelain 18 x 32
964411-01	Sink cover, RH
964410-01	Sink cover, LH
964700-01	Corner closeout, Corian
964679-01	Wall cabinet, above galley
964663	Face frame, galley wall cabinet
964678	Roof locker, galley, over sink
964662	Face frame, galley roof locker
964677-01	Roof locker, galley, RH
964661	Face frame, RH galley roof locker
961836	Magazine rack, galley side
963990	Magazine rack, dinette side
963991	Spice rack
200980-01	Tray, silverware
702952	Close out blind (conceals back of galley slide out when in closed position)

(continued)

# 2001 350/355 LAND YACHT XL

## FURNITURE

### GALLEY AREA W/SLIDE OUT

964668	Refrigerator cabinet assembly
964642	Face frame, refrigerator cabinet
381551-01	Pantry rack
381551-02	Wire basket, 4" white
964704-01	Dinette seat sub assembly, RH
964537	Back, upholstered RH dinette seat
964334-03	Flex spring seat, 21.63 x 32.00
964703-01	Dinette seat sub assembly, LH
964706	Dinette back sub assembly, LH
964707	Upholstered back, LH dinette seat
800631-004	Handrail, 23"
703125-02	Top dinette seat, urethane buckskin
964698	Table top, dinette, angle cut, Resistovar
962177-03	Leg, dinette table, hardwood, 30.5"
964675	Dinette roof locker
964638	Face frame, dinette roof locker



## 2001 350/355 LAND YACHT XL

### FURNITURE

#### CAB AND LOUNGE W/SLIDE OUT

964897	Roof locker, front (above windshield)
964893	Face frame, front roof locker
371374-01	Glass, tinted 9.88 x 21.56
371375-01	Glass, tinted 8.38 x 20.94
965086-014	Block, corner, front roof locker, RS
965086-024	Block, corner, front roof locker, CS
964895-02	Cab side panel, RS
964894-02	Face frame, RS cab panel
964895-01	Cab side panel, CS
964894-02	Face frame, CS cab panel
702897-03	Driver seat, power, w/padded skirt
702898-02	Passenger seat, non-power, w/padded skirt
*703088-399	Recliner, Phase III, Roman Sands
452277-01	Pedestal, swivel chair
452277-02	Plate, pedestal
*702800-399	Sofa, jack knife, 68", Roman Sands
963507-02	Close out, upper cab, RS
963507-01	Close out, upper cab, CS
964746	Stop, front windshield wrap, Oak, 3.5" x 43"
381515-04	Visor, front windshield
203198-01	Cover, A-post, RS
203198-02	Cover, A-post, CS
203040	Cover, center windshield post

\*Changing the-(dash) number to:

350= Georgia Peach

379 = Mosaic Blue

389 = Tropical Isle

# 2001 350/355 LAND YACHT XL

## FURNITURE

### CAB and LOUNGE W/SLIDE OUT

964546-01	Armrest assembly, driver
964547-01	Armrest assembly, passenger
203196	Cup holder, black, 3"
702192-08	Map pocket
964744	Header cabinet, main door
963809-01	Face frame, door header cabinet
800457	Dowel rod, Oak, 1/2"
800577-13	Trim, decorative, 25.25
964676	Roof locker, lounge, CS
964639	Face frame, CS lounge roof locker
964743	Roof locker, lounge, RS, over sofa
964423	Face frame, RS lounge roof locker
964451-01	End cap, roof locker, LH
964451-02	End cap, roof locker, RH

# 2001 350/355 LAND YACHT XL

## HARDWARE EXTERIOR-MAIN/SCREEN DOOR

### TRIMARK main door lock

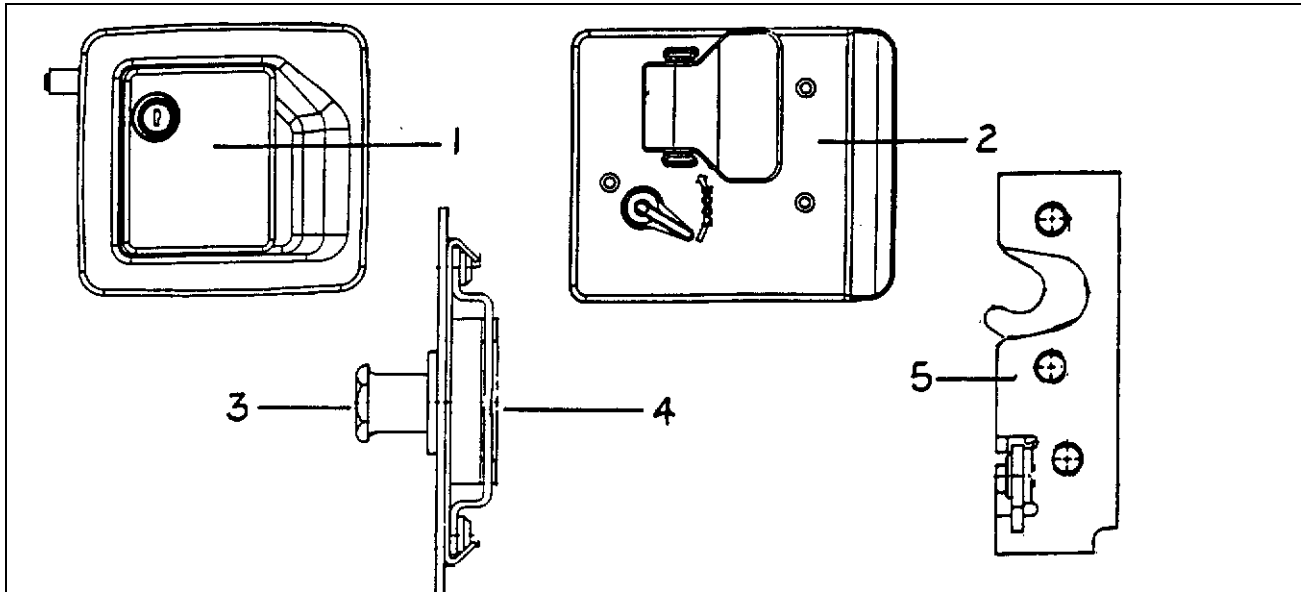

- |              |                           |
|--------------|---------------------------|
| 1) 381521-01 | Outside lock housing      |
| 2) 381521-02 | Inside lock plate         |
| 3) 381284    | Striker bolt              |
| 4) 381521-04 | Caged nut                 |
| 5) 381521-03 | Rotary latch              |
| 381521-05    | Screws, inside lock plate |

### Dead bolt-Tri-mark

- |           |                                     |
|-----------|-------------------------------------|
| 510802-01 | Actuator, door lock, 5-wire         |
| 381323-01 | Dead bolt assembly                  |
| 452030    | Bolt, Tri-mark dead bolt            |
| 381326    | Striker, 10007 w/Tri-mark dead bolt |
| 345321-12 | Screw, #8-32, flat head, black      |
| 200772    | Pan, plastic, dead bolt, interior   |

# 2001 350/355 LAND YACHT XL

## HARDWARE EXTERIOR-MAIN/SCREEN DOOR



381696  
handle, embossed, grab  
"AIRSTREAM"

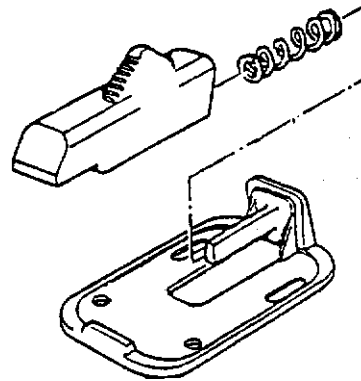

380291  
Main door hold back  
(used w/housing #380290)

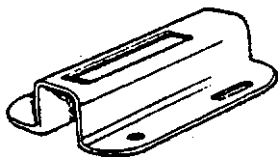

380290 Latch housing  
main door holdback

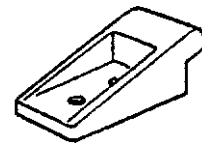

201056 Catch, main door  
holdback

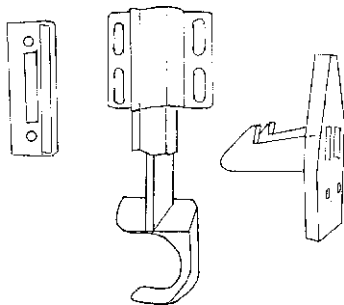

381454  
Latch, screen door, Bullet

## 2001 350/355 LAND YACHT XL

### HARDWARE

#### EXTERIOR MAIN/SCREEN DOOR

381334	Hinge leaf, jamb, main door
381336	Hinge leaf, door, main
381377	Hinge leaf, screen door
385599-075	Bearing, sleeve, main door hinge
300118-01	Washer, nylon, main door hinge
310024	Hinge pin, .250 x 6.0"
203002	Cover, inner door lock
380004	Handle, with screw, screen door
203000	Close-out, screen door, plastic slide
380079	Screen, gray
200518	Spline, gray, screen door

#### WINDOW, SE-GI CO.

371366-100	Weep hole cover, SE-GI window
371366-101	Sweep latch, SE-GI window

#### HOOD

381638-01	Hood release kit
381638	Hinge, hood

# 2001 350/355 LAND YACHT XL

## HARDWARE

### EXTERIOR-LOWER COMPARTMENT

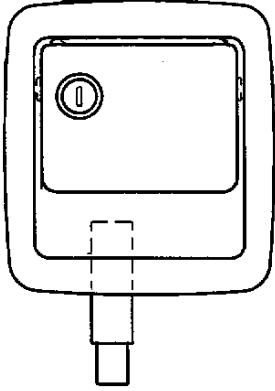

\*381637-01  
Latch, lower comp.  
Locking

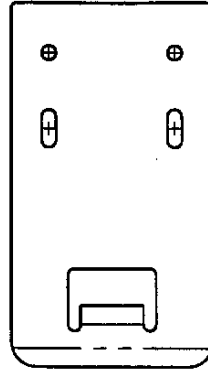

453707  
Strike plate, comp.  
latch

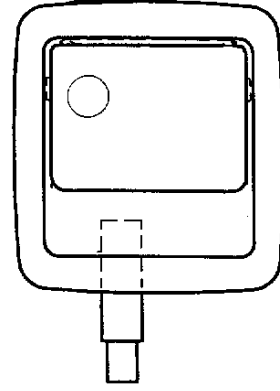

381637-02  
Latch, lower comp.  
non-locking



381569-02 Prop, gas spring, 60#  
381569-04 Prop, gas spring, 20#  
381569-01 Prop, gas spring, 50#

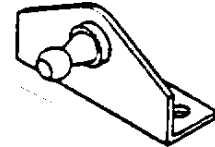

381262  
Prop bracket w/ball,  
angle, door mount

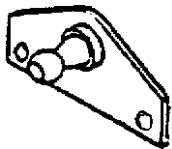

381263 Prop bracket w/ball  
straight, jamb mount

LPG door only;  
381659-01 Prop, 16" mech.  
381659-02 Bracket, 16" prop  
381659-03 Clip, 16" prop

\*381637-04 Key, lower compartment, TM 500

# 2001 350/355 LAND YACHT XL

## HARDWARE

### EXTERIOR-LOWER COMPARTMENT

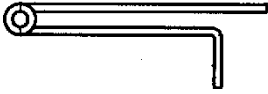

381650  
Hinge, lower comp.  
(used on short doors  
below slide outs)

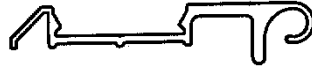

114864  
Hinge, lower comp  
body side

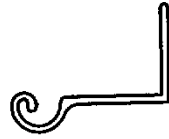

114863  
Hinge, lower comp  
door side

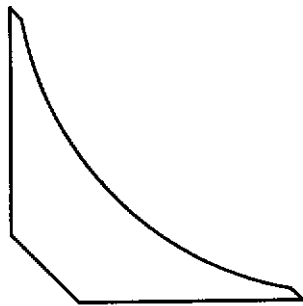

203184 Corner trim  
lower compartment,  
black plastic

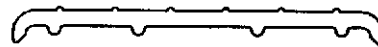

114869  
Extrusion, threshold,  
lower compartment

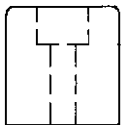

381136 Rubber bumper,  
3/4" tall, black

# 2001 350/355 LAND YACHT XL

## HARDWARE

### Exterior, Lower compartment

385934-05	J-Hook, black, heavy duty
964705	Door, inner compartment, 69.25"
381109	Bunk latch
381659-01	Prop, 16' mech. door
381659-02	Bracket, 16' prop
381659-03	Clip, 16' prop
381662	S-Hook, zinc chromate
381661	Chain, sash, cadmium plated
385934-07	Cargo net, 12" x 52"
385934-08	Cargo net, 12"x31"
385934-09	Cargo net 12" x 64"
385934-10	Cargo net, 12" x 32"



## 2001 350/355 LAND YACHT XL

### HARDWARE SLIDE OUT ROOM Bedroom

381646	*Slide out system, Power Gear, bedroom
801216	Runner, bedroom roller
114885	Bracket, slide roller
381623	Roller, floor slide out
381710	Bar, travel lock, bedroom, 22.25, adjustable
702949-02	Cover, bedroom slide out, Dometic
702949-01	Hardware slide out cover

### GALLEY

410826*	Slide out system, Power Gear, galley
381623	Roller, floor slide out
381709	Bar, travel lock, 18.50", adjustable, galley
702949-03	Cover, galley slide out, Dometic
702949-01	Hardware, slide out cover

\*For reference only-Airstream does not stock Power Gear parts.

Power Gear800-334-4712

# 2001 350/355 LAND YACHT XL

LET DATE	E.C.N.	REVISION RECORD	BY
10/98	4727	PRODUCTION RELEASE	JH

110602

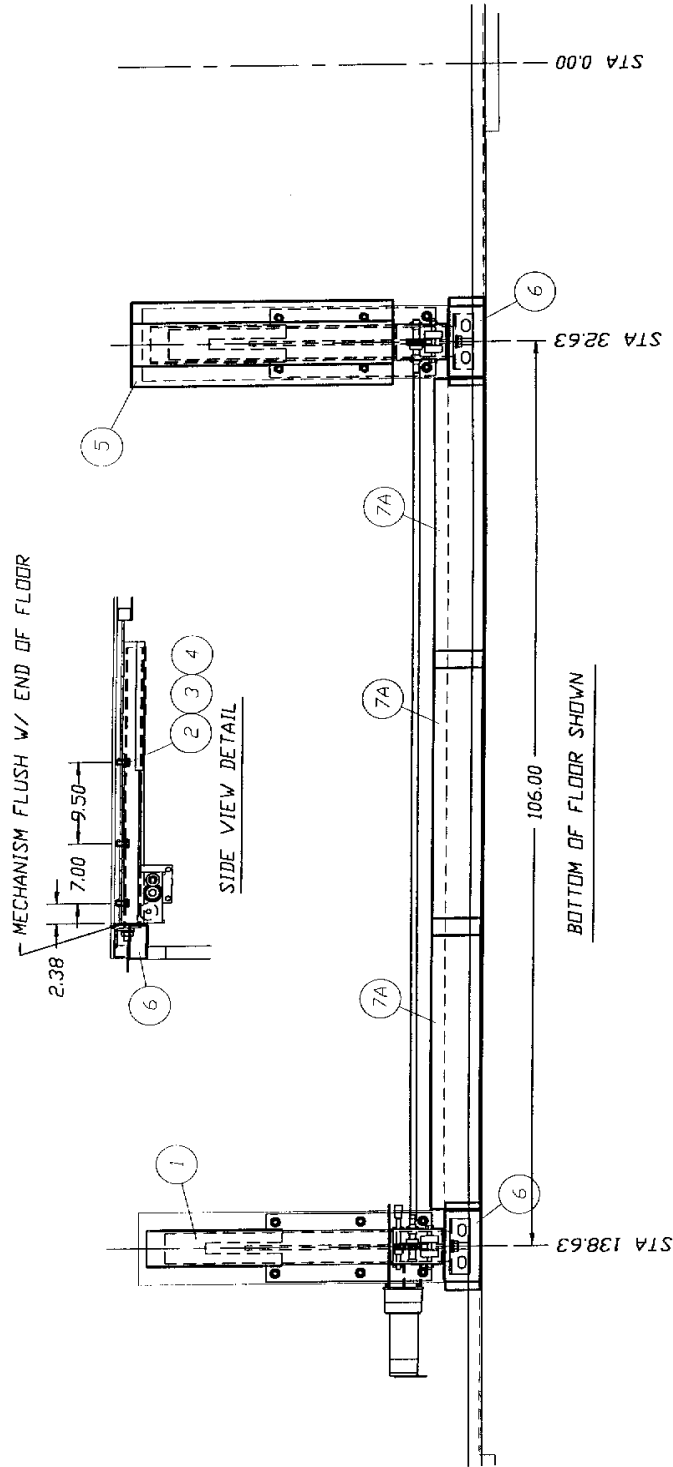

ITEM	PART NUMBER	DESCRIPTION	QTY	UM
7A				
7	452276	GALV 5.50 X 34.00	3 EA	TOLERANCES
6	453703	20 GA GALVANIZED STEEL	3.90 SF	±
5	453695	CLOSE-OUT, SLIDE MECH	2 EA	NEXT ASSY
4	300072-08	HAT SECT. CLOSE-OUT, SLIDE MECH	1 EA	
3	300112-50	WASHER, 1/2" LOCK	12 EA	TITLE
2	345269-04	FLAT WASHER, 1/2IN TYPE B	12 EA	
1	410826	SCREW, CAP HH GR. 5 1/2-13 X 1	12 EA	
		SLIDE-OUT SYS:POWER GEAR XL	1 EA	

<b>Airstream</b>	
DRAWN BY JH	APPROVED BY
FIRST USAGE: LANDYACHT XL	
TITLE <b>INSTALL SLIDE MECH., GALLEY</b>	

SCALE	DATE	DRAWING NUMBER	REV.
1=12	10/28/98	110602	B

# 2001 350/355 LAND YACHT XL

## HARDWARE-AWNING

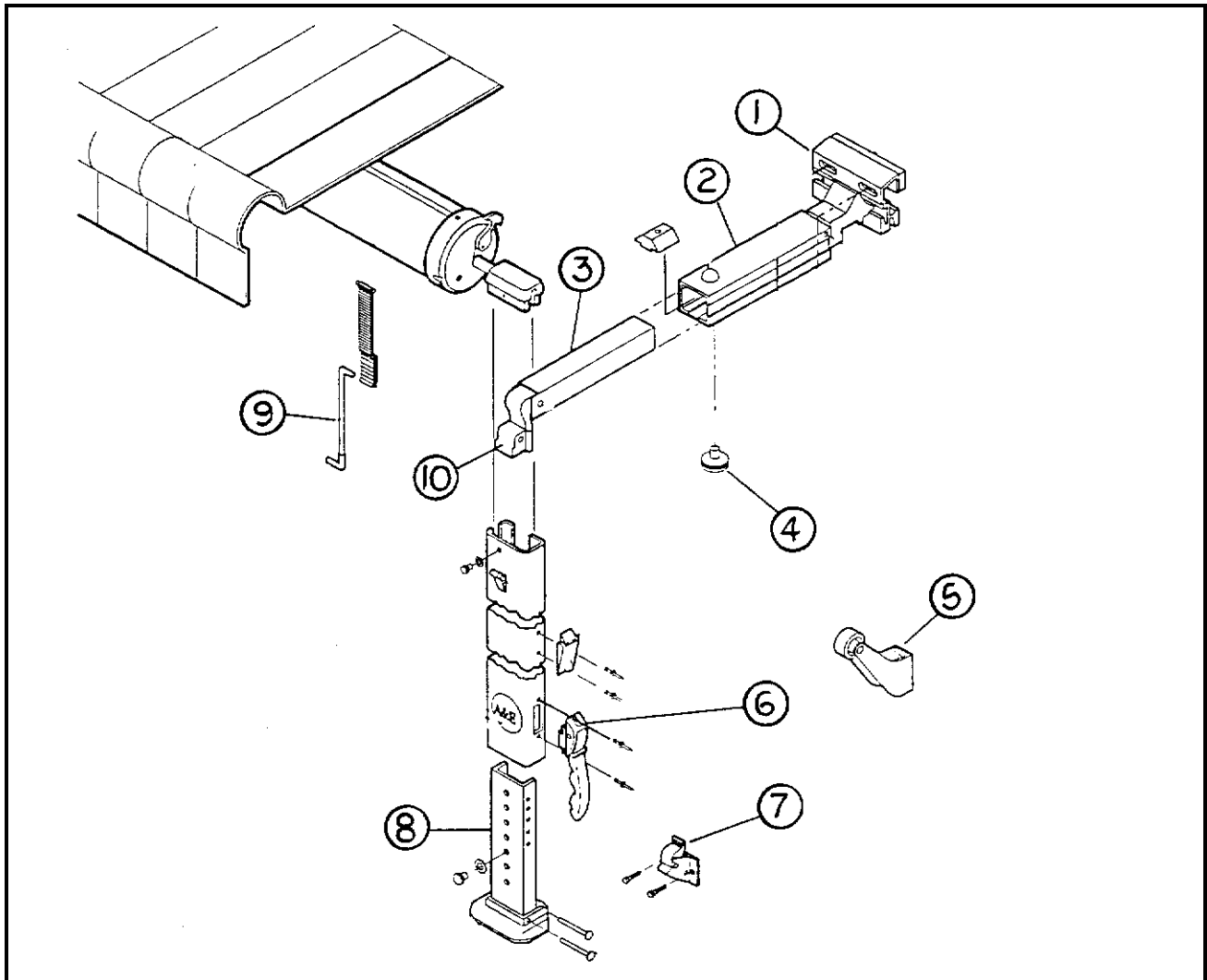

- |                |                                      |
|----------------|--------------------------------------|
| 1) 702679-104  | Bracket top, A&E awning              |
| 2) 702679-103  | Rafter, main, A&E awning             |
| 3) 702679-105  | Secondary rafter, A&E awning         |
| 4) 702679-106  | Knob, adjustment, 1 7/8" A&E awning  |
| 5) 702679-109  | Door roller, A&E awning              |
| 6) 702679-111  | Lift handle, A&E awning              |
| 7) 702679-108  | Bracket, bottom mounting, A&E awning |
| 8) 702679-107  | Arm, adjustable, A&E awning          |
| 9) 702679-102  | E-Z pull rod, A&E awning             |
| 10) 702679-110 | Slider assembly, A&E awning          |

# 2001 350/355 LAND YACHT XL

## HARDWARE INTERIOR LATCHES/HINGES

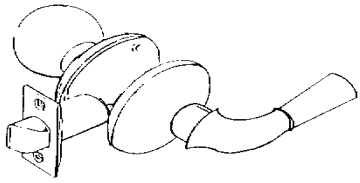

381022 Latch, swinging  
bath door

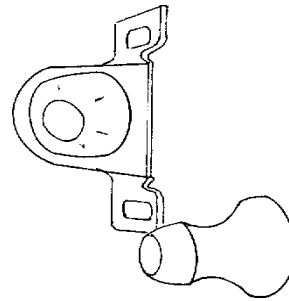

381074 Bulldog  
door catch

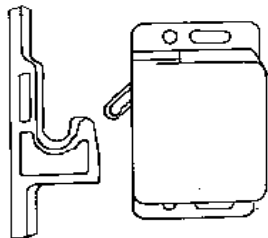

381228 Grabber door  
latch w/catch, 10lb.rating  
381228-01 Grabber door  
latch w/catch, 3lb. Rating



381228-100  
Catch only, grabber  
door latch



381566 Loop, footman,  
steel, plated

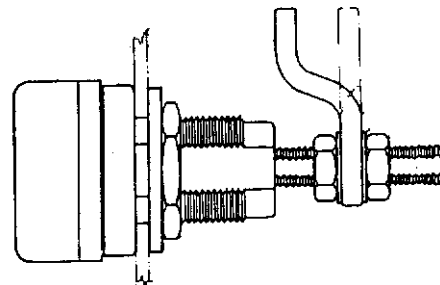

381227-01 Vise-action latch,  
curved pawl  
381227-02 Vise-action latch,  
straight pawl

2001 350/355 LAND YACHT XL

HARDWARE  
INTERIOR LATCHES/HINGES

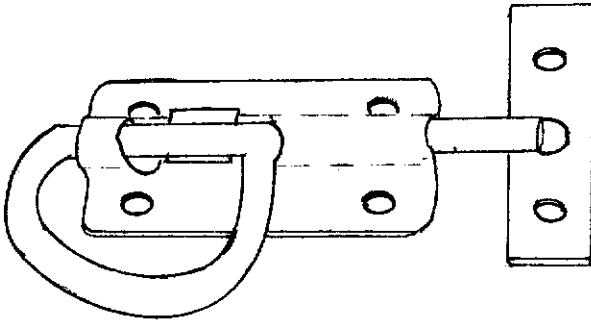

381109 Slide bolt latch

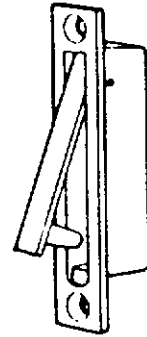

381444 Hatch pull

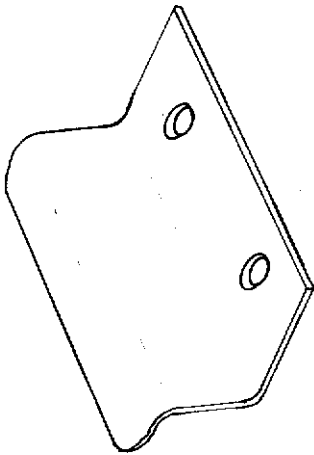

385940 Mirror pull, brass

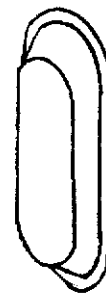

381603 Pull, three three-finger, brass

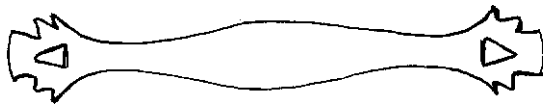

381599 Pull handle, drawer/door  
Antique Brass

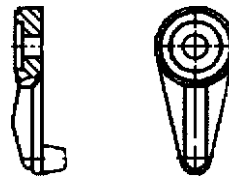

381612 Clip, mirror retainer  
brown

# 2001 350/355 LAND YACHT XL

## HARDWARE INTERIOR LATCHES/HINGES

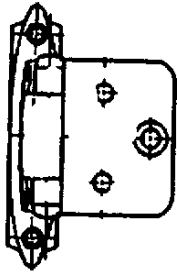

381601 Hinge, Antique  
Brass

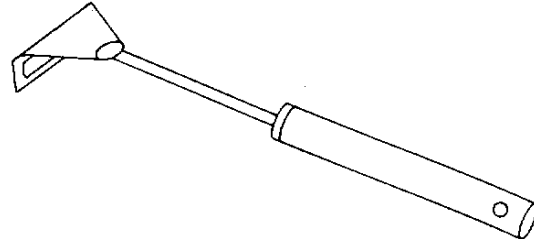

381147 Door support  
spring loaded

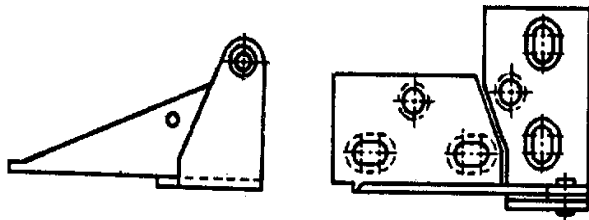

385935 Hinge, pivot, brass  
for bath mirror



360012-01 Bumper  
rubber, brown, cylindrical

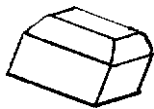

360016 Bumper, rubber  
Gray, square, 3/8x3/8  
sliding doors

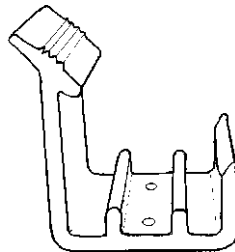

381643-01  
Travel latch, rear wardrobe

# 2001 350/355 LAND YACHT XL

## HARDWARE INTERIOR

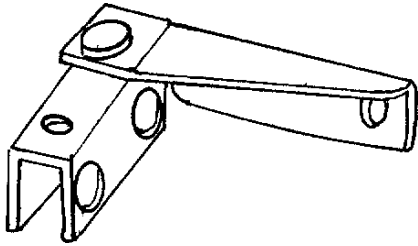

381654  
Hinge, non bore  
glass door, black



381655  
Strike, glass door,  
black

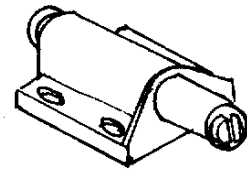

381653  
Latch, single  
touch, black

- 381526-02      Drawer slide, 700RV, 16"
- 381526-03      Drawer slide, 700RV, 18"
- 381526-05      Drawer slide, 700RV, 22"
- 381526-01      Drawer slide, 950RV, 14"
- 381526-06      Rear bracket, adjustable, drawer slide
  
- 381443-01      Sliding door set, w/ carriers, top plate and track
- 381100          Sliding door guide
- 381658          Drawer guides, round-used at pocket door
  
- 381626-02      Towel bar, chrome and brass
- 380248          Soap holder, chrome
- 380034          Toilet paper holder, chrome
- 380017          Holder, toothbrush and tumbler
  
- \*381385          Dual lock #400
- \*381386          Dual lock #170
  
- 380045          Clothes rod
- 200975-04      Conduit, flexible, black plastic(covers rod)
- 380046          Clothes rod mounting bracket
- 381298          "J" bracket, center clothes rod support

\*These two parts work similar to Velcro but have inter-locking knobs rather than hooks and loops.

# 2001 350/355 LAND YACHT XL

## HARDWARE INTERIOR

381067-09	Gas spring, 90#, rear bed
381262	Bracket, prop, with ball, angle
381084	Ball stud, for gas spring
381085	Clip, prop retainer
381263	Bracket, prop, with ball, straight
381400	Slide, drawer, 14", rear bed
381400-01	Slide, drawer, 12", rear bed
381220-02	Mirror clip, nickel plated
114909-01	Bracket, TV mount, RH, bedroom
114909-02	Bracket, TV mount, LH, bedroom
381310	Gas prop bracket, upper
381562-04	Gas spring, 20#, rear TV



# 2001 350/355 LAND YACHT XL

## SECTION IV L through Z

LABELS and TAGS ..... IV-1

OPTIONS..... IV-3

### PLUMBING

LPG ..... IV-5

Utility compartment ..... IV-6

Fresh water ..... IV-7

Faucets..... IV-9

Drain water ..... IV-12

Toilet..... IV-16

SAFETY EQUIPMENT..... IV-19

### SEALS/SEALER/PAINT

Gaskets ..... IV-20

Sealer..... IV-22

Adhesive ..... IV-22

Paint ..... IV-23

UPHOLSTERY/FOAM/MATTRESS .... IV-24

VENTS/FANS ..... IV-30

WOOD/INTERIOR TRIM ..... IV-31



# 2001 350/355 LAND YACHT XL

## LABELS AND TAGS

385103	Plate, RVIA
385531	FMVSS certification label
385815	Name plate, motorhome hitch rating
385095	Tag registry#11999
385465	Label, exit warning (English)
385463	Label, warning label/cooking appliance
385464	Label, LP gas warning label (odor)
385788	Warning label, pilot light/refuel
385101	Tag, auxiliary tank dump valve handle
385099	Tag, black tank dump valve handle
385063	Label, drain cap
385062	Decal, 110-125 voltage AC
385309	Decal, fuel fill
385547	LP gas warning/fill label
385141	Tag, seat, clear w/black letters
385518	Label, dimension and clearance
385193	Label, 12Volt distribution inside
385560	Air conditioner rating label
385561	Generator rating label
385565	Label, holding tank flushing
385805-01	A/C priority switch label-front
385805-02	A/C priority switch label-rear
385812	Label, Calif. hazardous substance
385609	Label, smoke detector
385612	Label, parking brake warning
385620	Label, unleaded fuel only
385829	Decal, fuse and relay
385828	Decal, fuse panel warning
385851	Label, cellular phone

(continued)

# 2001 350/355 LAND YACHT XL

## LABELS AND TAGS

385933	Label, name set relay
385941	Label, waste water holding
385942	Label, sewage holding tank
385943	Label, "cap must be in place"
385947	Label, 10-amp fuse maximum
385098	Label, seat occupancy
386012	Label, warning, water heater
385608	Label, sewer hose
385829	Decal, fuse and relay
385828	Decal, fuse panel
385931	Decal sheet, utility compartment
385989	Decal, mirror heat
385946	Label, warning, slide out operation
386014	Decal set, batt/aux start solenoid
386015	Decal set, 12v.circuit breaker
386016	Decal set, converter breaker

## 2001 350/355 LAND YACHT XL

### OPTIONS

690413	VCR, Sony, SLV N50
511439	Inverter, 400W, operates front TV from 12volt
203153-01	Skylight, 22 x 22 clear
203152-03	Skylight trim out 22 x 22 x 4
702804-02	Shade, pleated, 20.25 x 21.00
381564	Vent w/wall thermostat, Fantastic #2000TRS
690396-05	Range, 3-burner w/oven, Magic Chef
690425-03	Refrigerator, 10CF, 2-way, RH, NDR1062, w/ice
801225-014	Refrigerator door insert, 15.5" x 20.38"
801225-034	Refrigerator door insert, 38.38" x 120.38"
690415	Kit, dairy, meat and ice cube tray, RM3962
511005	Generator, Onan, Marquis, 7000
702679-53	Awning, window, 4', Black Shadow
702679-49	Awning, window, 4', Teal Tweed
702679-51	Awning, window, 4', Taupe
702679-50	Awning, window, 4', Saffire Blue
702679-12	Hardware, awning, window
963421-01	Table assembly, free standing, Oak NOMAR
963421-02	Table assembly, free standing, Oak laminate
703009-03	Chair, dinette, folding, Oak
801247-004	Table, stationary, Oak NOMAR
964948-01	Shelf, lift-up, galley

## 2001 350/355 LAND YACHT XL

### OPTIONS

511162-01	Keyless entry w/remote
511162-02	Transmitter, 4 channel
511352	Module, locking, centralized
511149-04	Power cord, 50 amp 36'
510562-03	Switch-transfer, automatic, 50 amp
511149-02	Power inlet w/strain relief, 50 amp
702897-04	Passenger cab seat, power, padded skirt
703022-01	Swivel chair, leather
703088-01	Recliner, Phase III, leather
702818	Shade-Kool screen, black, cab area
690386	Toilet, Thetford China
511376	Fan, defrost, oscillating
702903-06	Tile 12"x12" KPT/Moraco
702903-07	Grout-Ivory #39

# 2001 350/355 LAND YACHT XL

## PLUMBING

### LPG

601500	LP tank, 105# w/sender
511229	Sending unit, 90 ohm, Snap-on
601674	Regulator, LP gas, 2-stage
201335	Access cover, LP regulator
601673-02	LP hose, low pressure, 3/8" x 48"
601673-01	LP hose, low pressure, 3/8" x 48"
601279	LP hose, low pressure, 18in.
601412-08	Connector, 1/2" pipe to 3/8" flare
601412-12	Connector, 1/2" pipe to 5/8" flare
600003	Tee, 5/8" x 3/8" x 3/8" brass, flare
600004	Tubing, copper, 5/8"
600008	Tubing, copper, 3/8"
600436	Flare nuts, forged, 5/8"
600435	Flare nuts, forged, 3/8"

# 2001 350/355 LAND YACHT XL

## PLUMBING

### FRESH WATER-UTILITY COMPARTMENT

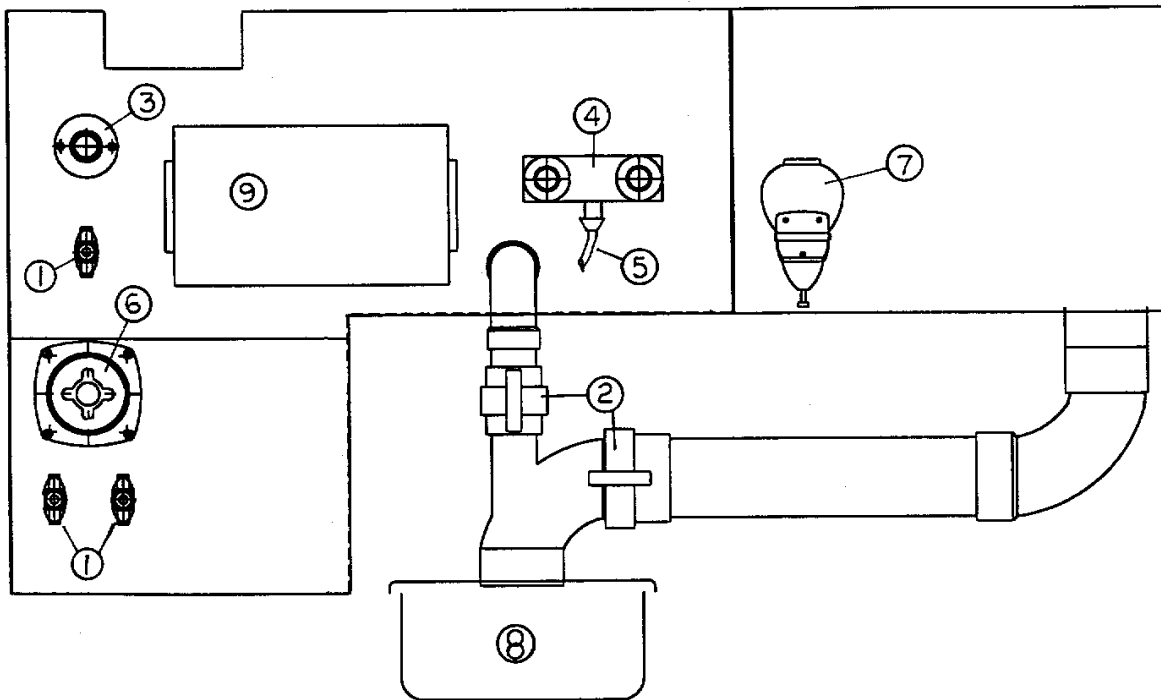

- |               |                                 |
|---------------|---------------------------------|
| 1) 601698-07  | Shut-off, ½" barb x ½" barb     |
| *2)           | Dump valve rods                 |
| *3) 601197-01 | Water hook up, black tank flush |
| 4) 601592-03  | Shower valve                    |
| 5) 601592-02  | Shower hose, white, 59"         |
| 6) 601392     | City water hook-up w/regulator  |
| 7) 381651     | Dispenser, liquid soap          |
| 8) 203201     | Pan, sewer hose storage         |
| 9) 203035     | Holder, paper towel             |

\*See drainage for more detail



# 2001 350/355 LAND YACHT XL

## PLUMBING FRESH WATER

601724-01	Tank, fresh water
601238	Adaptor 1.25MPT X 1.25 Barb
601239	Hose, 1.375I.D., water tank fill
601709	Check valve, w/rubber flap(over flow)
600139	Check valve, brass
601061-03	Water pump, Shurflo
601668	Filter, pre water pump
601392	City water hook-up w/regulator
601733	Hose, 36" vinyl riser(used on galley slide out)

## FITTINGS

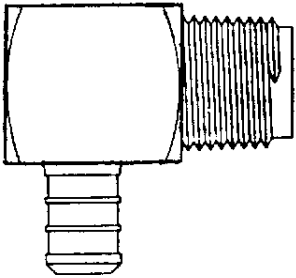

601698-04  
Elbow, 1/2" barb  
x 1/2" MPT

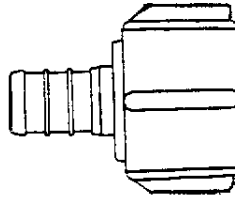

601698-03  
Coupler, 1/2" barb  
x 1/2" FPT

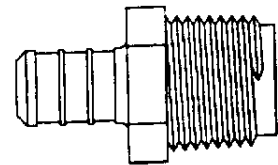

601698-02  
Coupler, 1/2" barb  
x 1/2" MPT

(Continued)

# 2001 350/355 LAND YACHT XL

## PLUMBING FRESH WATER-FITTINGS

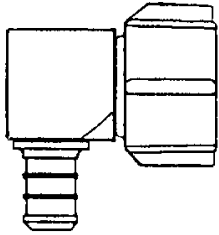

601698-05  
Elbow 1/2" barb x  
1/2" FPT

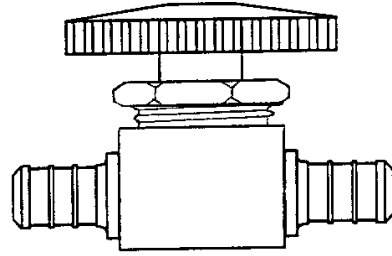

601698-07  
Shut-off, 1/2" barb x  
1/2" barb

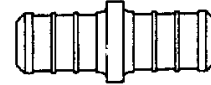

601698-08  
Coupler  
1/2" x 1/2" barb

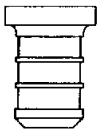

601698-09  
Plug, 1/2" barb  
1/2" barb 1/2" barb

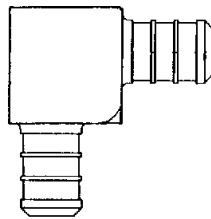

601698-10  
Elbow 1/2" barb x

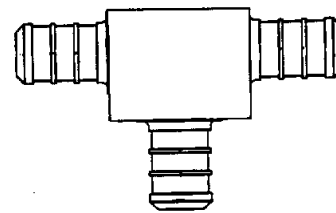

601698-11  
Tee, 1/2" x 1/2" x



601698-15  
Crimp ring, 1/2  
E-Pex, 1/2" (black)



601698-01  
E-Pex tube, 1/2"

# 2001 350/355 LAND YACHT XL

## PLUMBING-FAUCETS 601771 Moen Pure Touch Classic

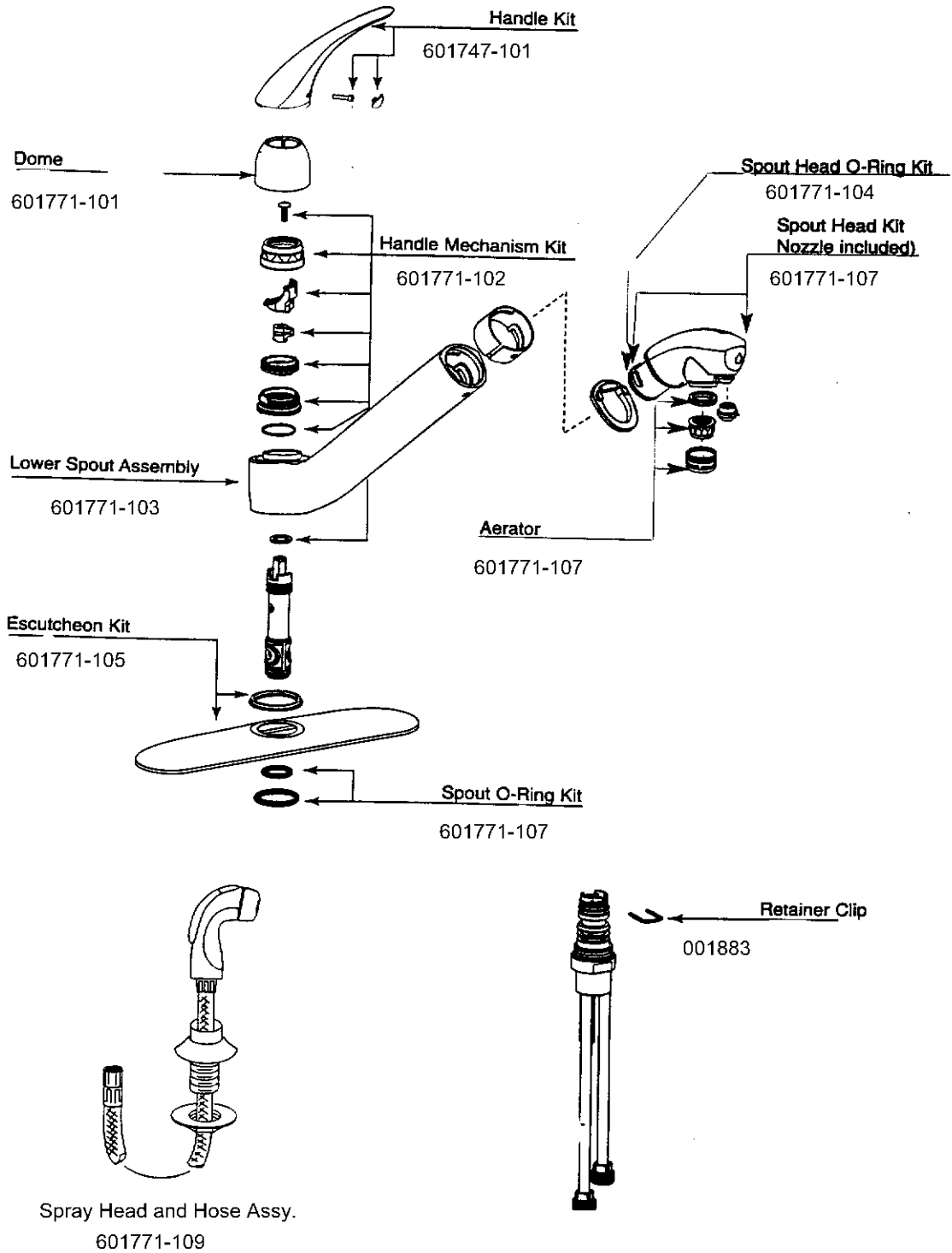

# 2001 350/355 LAND YACHT XL

## PLUMBING FRESH WATER-FAUCETS

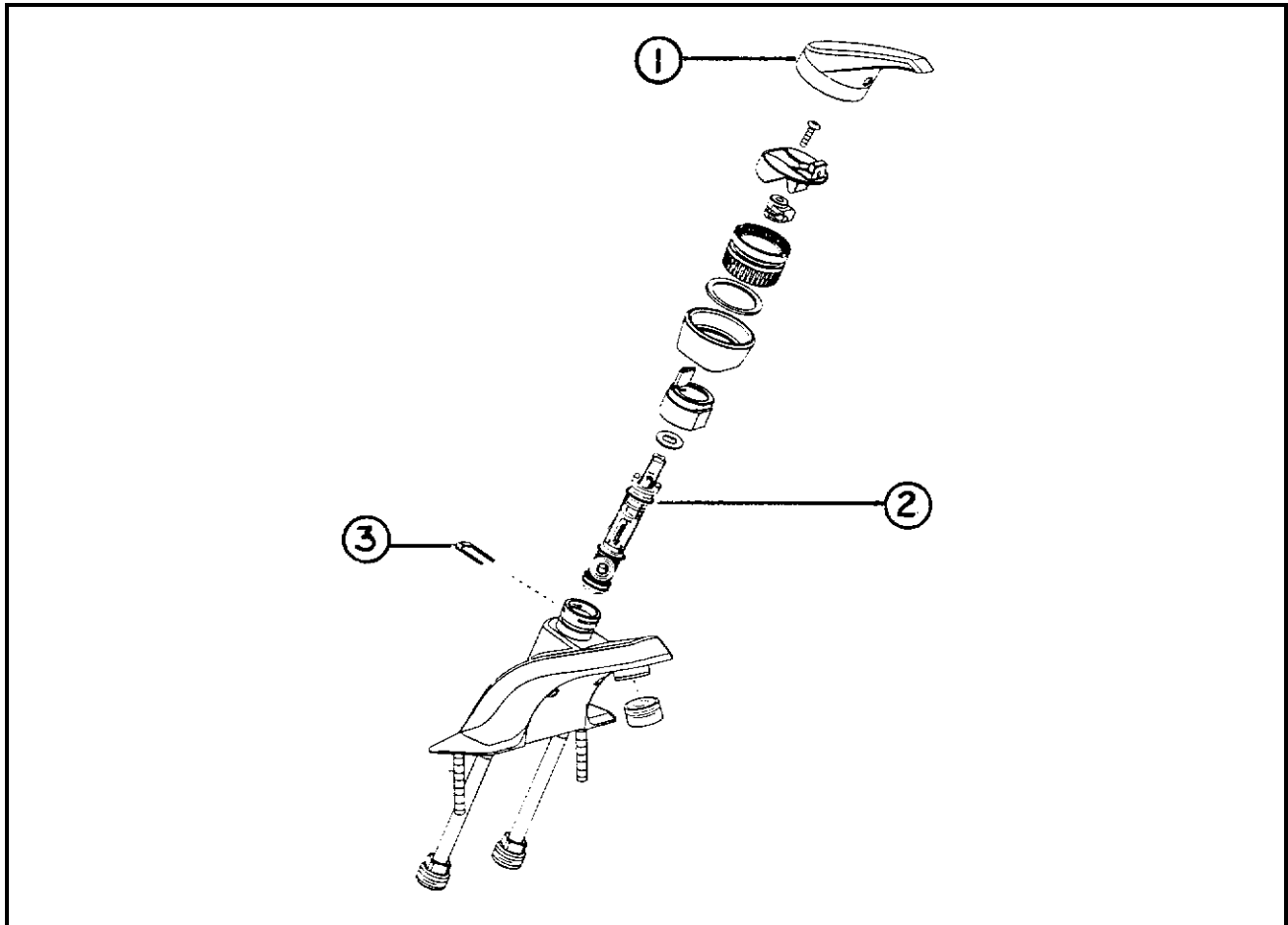

690390-02Faucet, lavatory, Moen, brass/chrome

- |               |               |
|---------------|---------------|
| 1) 690390-100 | Lever handle  |
| 2) 601579-105 | Cartridge     |
| 3) 601579-104 | Retainer clip |

# 2001 350/355 LAND YACHT XL

## PLUMBING FRESH WATER-FAUCETS

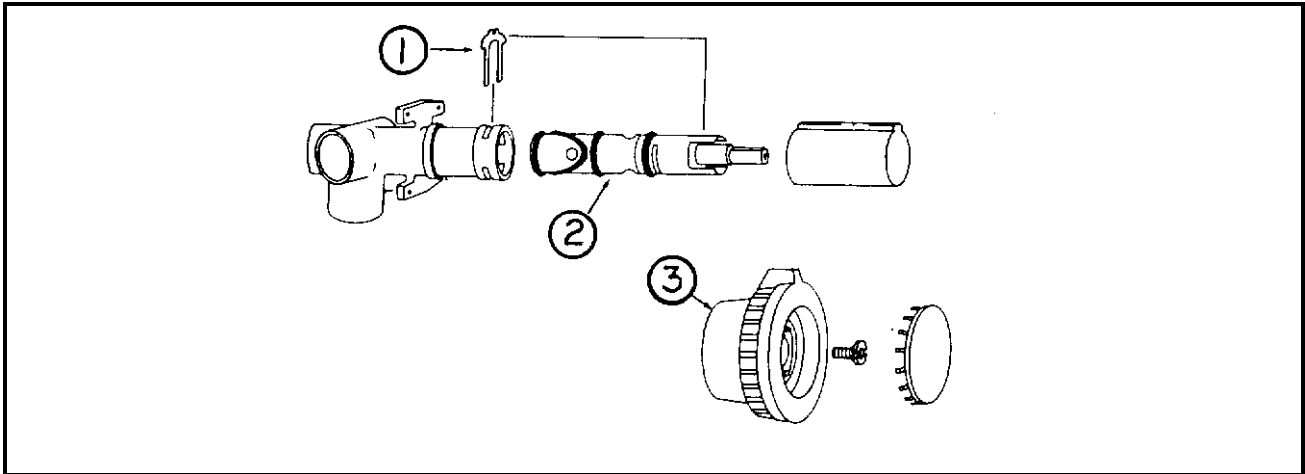

601420-02Faucet, shower

- |               |               |
|---------------|---------------|
| 1) 000883     | Retainer clip |
| 2) 601420-100 | Cartridge     |
| 3) 001041     | Handle        |

- |            |                        |
|------------|------------------------|
| 601358-100 | Shower head , chrome   |
| 600330     | Shower hose, chrome    |
| 600332     | Vacuum breaker, chrome |

## 2001 350/355 LAND YACHT XL

### PLUMBING DRAIN SYSTEM

601726-01	Holding tank, gray
601725-01	Holding tank, black
203183	Slope pad, holding tanks
601441	Tank flush, no-fuss(vacuum breaker and check valve)
601441-01	Nozzle, tank mounted, no-fuss flush
601197-01	Water hook-up, chrome, black tank flush
601607-08	Sewer hose, 20', w/hose adaptor
203201	Pan, sewer hose storage
381463-02	Hatch, black, 5"-sewer hose

### FITTINGS-BELOW FLOOR

601470	Dump valves, Valterra (includes both valves and drop out)
195329-229	Reducer adapter, 3" to 1.5"
600820	3" Single socket, 90 degree
601160-02	Pipe, ABS, 1.5"
601160-04	Pipe, ABS, 3.0"
601250	Bayonet cap, 3"

# 2001 350/355 LAND YACHT XL

## PLUMBING DRAIN SYSTEM-ABOVE FLOOR

- 601266 Closet flange, 3 x 4, slip fit, tank to toilet adapter.
- 203180-01 Shower stall  
601727 Drain, shower, 2" w/grid
- 200406 Lavy bowl, Karran  
601633-06 Sink, galley, porcelain, Almond  
600968 Basket, strainer
- 601700 Hose, drain, Kaf-Flex 1.5, galley slide out  
964233 Plumbing support, galley slide out

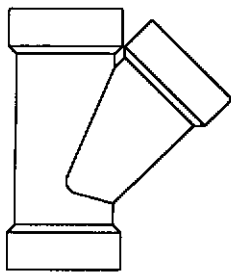

**WYE**  
**#2301**  
**600094**

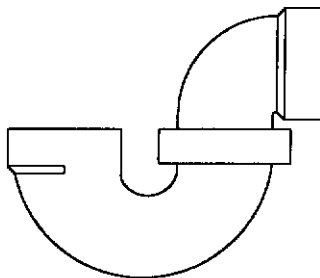

**P-TRAP**  
**1.5" W/O SLIP NUT**  
**600144**

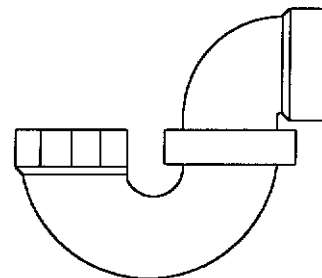

**P-TRAP**  
**1.5" WITH SLIP NUT**  
**600622**

# 2001 350/355 LAND YACHT XL

## FITTINGS, 1.5" PLASTIC

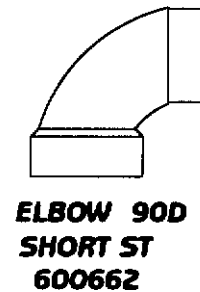
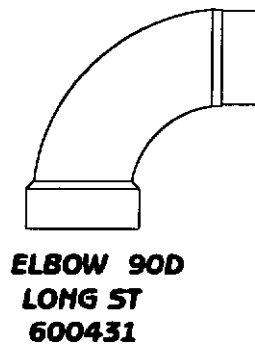
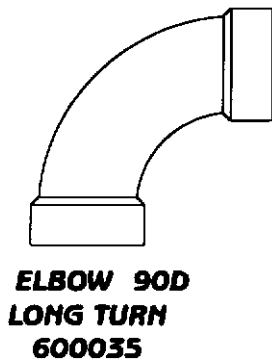
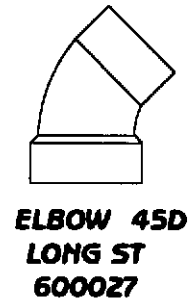
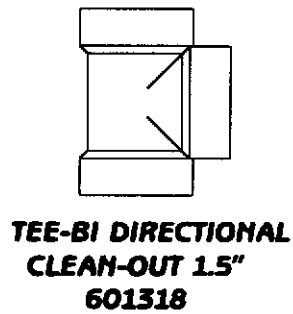
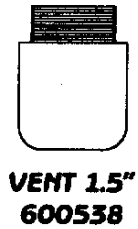

(continued)



# 2001 350/355 LAND YACHT XL

## PLUMBING

### FITTINGS, 1.5" PLASTIC

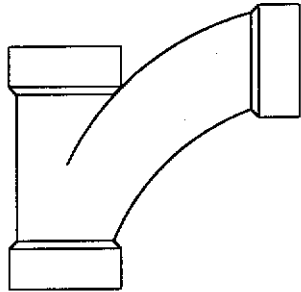

**WYE 1.5"  
1/8" BEND  
600182**

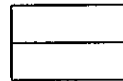

**COUPLING  
1.5"  
600227**

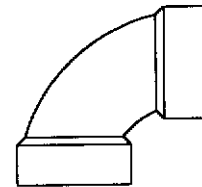

**ELBOW 90D  
SHORT SWEEP  
601636**

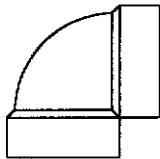

**ELBOW VENT  
90D  
600033**

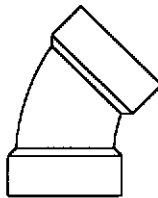

**ELBOW 45D  
LONG TURN  
600030**



**ELBOW 22.5D  
SHORT TURN  
600116**



**SWIVEL  
ADAPTER  
600442**

# 2001 350/355 LAND YACHT XL

## PLUMBING THETFORD, AQUA MAGIC GALAXY, PARCHMENT

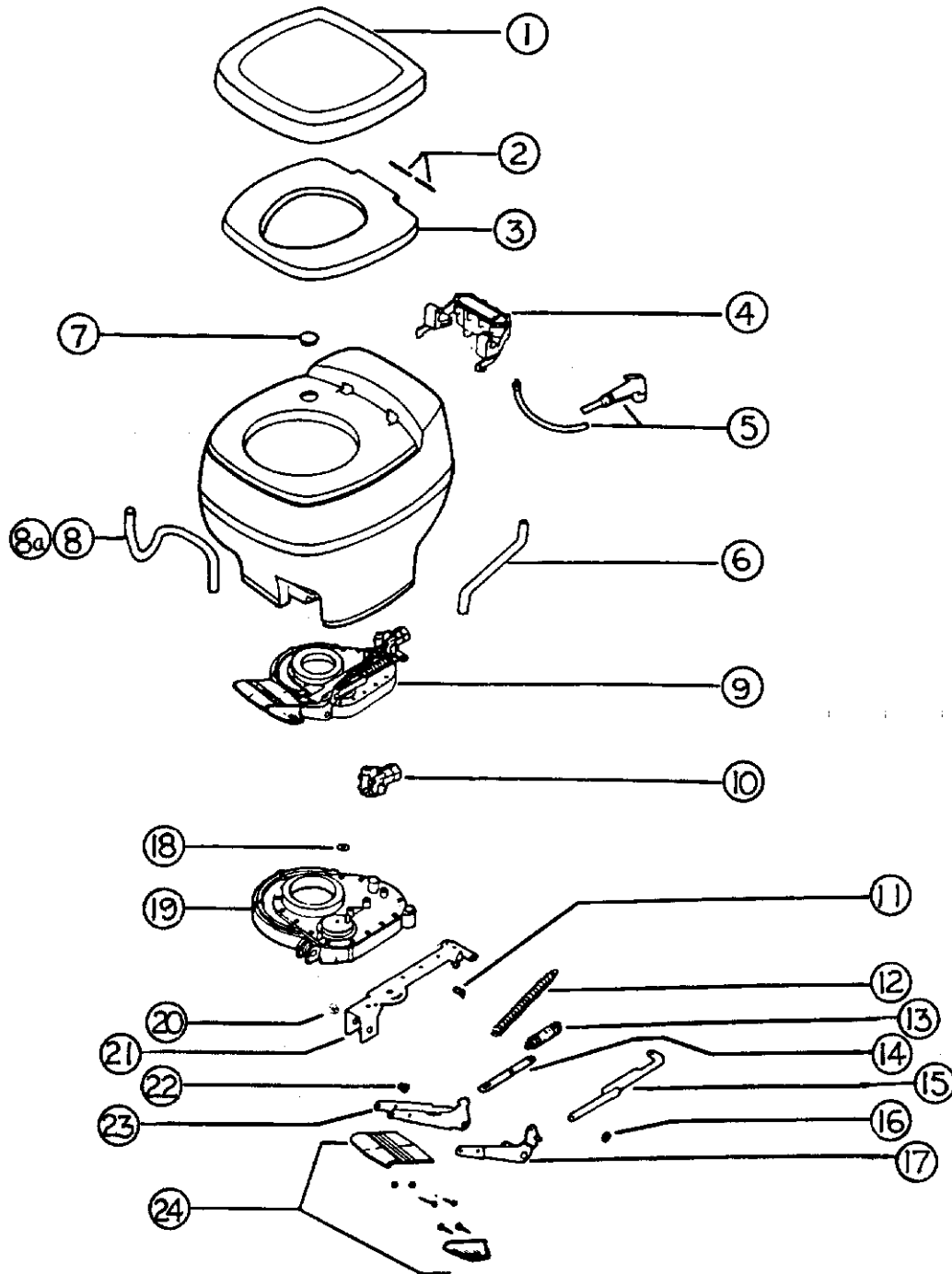

# 2001 350/355 LAND YACHT XL

## PLUMBING

THETFORD, AQUA MAGIC GALAXY, PARCHMENT

690327-02 Toilet complete, Aqua Magic Galaxy, high

- 1) 020925 Padded seat cover, parchment
- 2) 012986 Hinge pin
- 3) 1626457 Seat, parchment
- 4) 008217 Vacuum breaker w/water saver, parchment
- 5) 008993 Water saver package
- 6) 003728 Water supply tube
- 7) 003895 Hole plug, parchment
- 8) 003729 Trap tube, 20", low style
- 8a) 003727 Trap tube, 27", high style
- 9) 024203 Mechanism, parchment
- 10) 009868 Ball valve replacement package
- 11) 002391 Drive arm assembly
- 12) 002802 Spring, ball valve return
- 13) 002801 Spring
- 14) 008986 Push link
- 15) 002796 Drive arm
- 16) 002394 Ring, retainer
- 17) 009421 Pedal arm assembly
- 18) 008034 Retainer ring, 1/4"
- 19) 020929 Base and cover assembly
- 20) 003749 Bushing, mechanism
- 21) 012593 Lever plate
- 22) 003749 Bushing, mechanism
- 23) 019266 Pedal arm
- 24) 020930 Double pedal package

See next page for model used after 640949.

# 2001 350/355 LAND YACHT XL

## Bravura

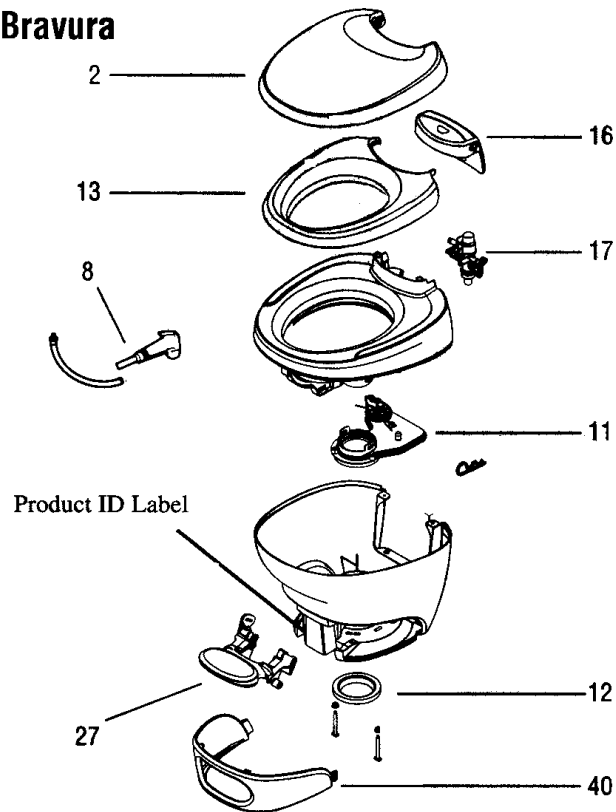

## Thetford Bravura P/N 690442-02

Before ordering parts, record the Product ID information.

No. Description	No. Description
1 Hinge Pins (2)	22 Bracket & 2 Screws†
2 Seat Cover	23 Float Assy.
3 Vacuum Breaker	24 Actuator Assy.
4 Flush Tube	25 Base to Bowl Screws (9)
5 Flush Nozzle Assy.	26 Closet Bolt Pkg.
6 Overflow Trap	27 Pedal Pkg.†
7 Water Supply Tube	28 Base
8 Hand Spray Kit (Water Saver Option Only)	29 Retainer & Screw†
9 Side Access Covers (2)	30 Sealant
10 Water Valve	31 Blade Spring
11 Lower Mechanism Assy.	32 Blade
12 Closet Flange Seal & Bolt Pkg.	33 Blade Seal
13 Seat	34 Blade Track
14 Hinge Post Kit	35 Flapper
15 Upper Mechanism Assy.	36 Overflow Tube
16 Pod	37 Nozzle Assy.
17 Water Module	38 Bowl
18 Water Valve Link	39 Reservoir Assy.
19 Lever Assy.*	40 Shroud
20 Wire Replacement Pkg.†	
21 Mechanism Cover	

**Specify High or Low**  
 \* Hand Flush only  
 † Foot-Pedal Flush only

## 2001 350/355 LAND YACHT XL

### SAFETY EQUIPMENT

510781	Detector, smoke #1056 w/silencer
511343	Detector, carbon monoxide-9 volt
511309	Detector, LPG
510734	Alarm, back-up
381069	Seat belt kit, cocktail chair
453676	Bracket, dinette seat belt, LH-double
453677	Bracket, dinette seat belt, RH-single
700349	Seat belt, mini buckle, black web
690381-01	Fire extinguisher, 10 B: CUL
690381-02	Fire extinguisher, 10 B: CULC (Canadian)
380188	Emergency warning triangle, set of 3

2001 350/355 LAND YACHT XL  
 SEALER, GASKETS, PAINT, ADHESIVES  
 GASKETS



1) 381663



2) 365237-01



3) 365232



4) 365214



5) 201260



6) 381640



7) 381665



8) 365013-01



9) 365045

- |              |   |
|--------------|---|
| 1) 381663    | Gasket, lower compartment door                        |
| 2) 365237-01 | Seal, dust, compartment door edge                     |
| 3) 365232    | Seal, compartment doorjamb                            |
| 4) 365214    | Gasket, seal-compartment door hinge and main doorjamb |
| 5) 201260    | Insert, windshield gasket, rubber                     |
| 6) 381640    | Gasket, windshield, includes center strip             |
| 7) 381665    | Gasket, window to body, door jamb                     |
| 8) 365013-01 | Gasket, screen door, low-density foam                 |
| 9) 365045    | Seal, main door                                       |

# 2001 350/355 LAND YACHT XL

## SEALS

Sealer, gaskets, paint, adhesives  
GASKETS-SE-GI WINDOWS



1) 371366-103



2) 371366-102



3) 371366-104



4) 371366-105

- |               |                                |
|---------------|--------------------------------|
| 1) 371366-103 | Track, window screen, Se-Gi    |
| 2) 371366-102 | Track, sliding pane, Se-Gi     |
| 3) 371366-104 | Wiper seal, vertical, Se-Gi    |
| 4) 371366-105 | Screw cover, clamp ring, Se-Gi |

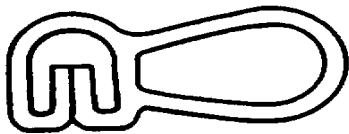

1) 381594 Rubber extrusion  
bulb type, black

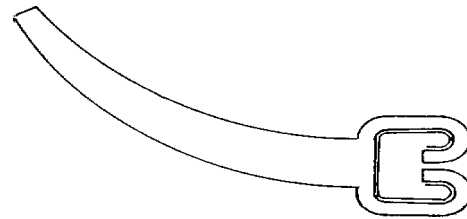

2) 381587 rubber extrusion,  
wiper



3) 381589 Rubber extrusion  
floor wiper



381663  
Rubber extrusion, bulb  
w/tape-used on inside wall

2001 350/355 LAND YACHT XL  
SEALER, GASKETS, PAINT, ADHESIVES

SEALER

360209-02	Sealer, black, windshield
360052	Vulkem sealer, black,
360180	Sika flex #221
360268-01	Liqua Seal, roof, white
360281	Sealant, thermoplastic rubber (clear)
360216	Caulk, latex, brown
365001	Tape, double coated foam
360074	Sealant, GE RTV, white
360001	Butyl sealant
360002	Vulkem sealant, gray
360176	Sealant, almond, bathroom
360210	Sealant, Paralastic #4334-04 (refrigerator Compartment sealer)
360283	Silicone sealer, Corian bone
360190	Sealant, white
360286	Sealant, gray
360255-03	Sealer, anti-wick



2001 350/355 LAND YACHT XL  
SEALER, GASKETS, PAINT, ADHESIVES

ADHESIVES

702791	Border adhesive
800639-02	Adhesive, Oak plank flooring
360270	Adhesive spray, sta-put, ceiling panels (Reference only, not available for shipment)
360261	Glue, urethane

PAINT

Each vehicle has been provided with a sheet listing the paint color codes on that particular motorhome.

Also, each motorhome is shipped with touch-up paint for each color. A back up color chart for each motorhome is kept in Airstream's files. If calling Airstream for this information ask for "Sales" and have the serial number available for them.

360208	Stain, gal, medium Oak
365244	Lacquer, clear, used on wood

MISCELLANEOUS

360179	Undercoat, Pennzoil II
6000329	Tape, silver, 2" wide
200518	Spline, gray, screen insert
380079	Screen, gray



2001 350/355 LAND YACHT XL

UPHOLSTERY/FOAM/MATTRESS

PILLOW KIT- GEORGIA PEACH

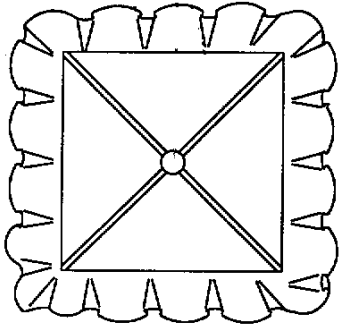

703062-01 Sofa pillow

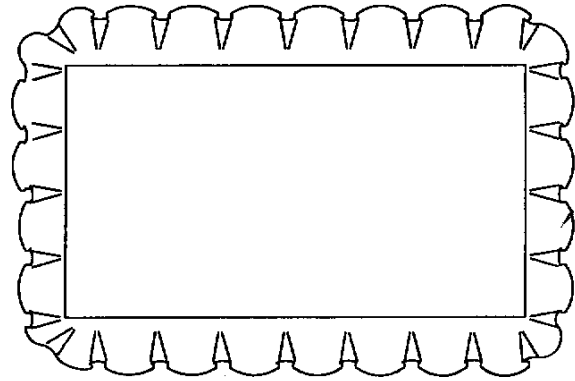

703062-02 Bedroom pillow shams

PILLOW KIT VINTAGE LEAF

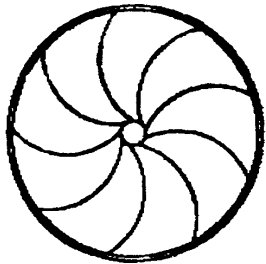

702932-01 Lounge Pillow

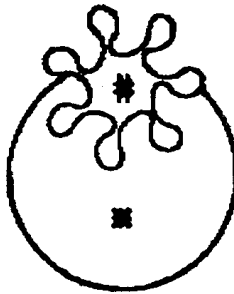

702932-02 Bedroom Pillow

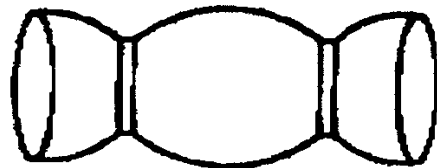

702932-03 Bedroom Pillow

2001 350/355 LAND YACHT XL

UPHOLSTERY/FOAM/MATTRESS

PILLOW KIT-MOSAIC BLUE

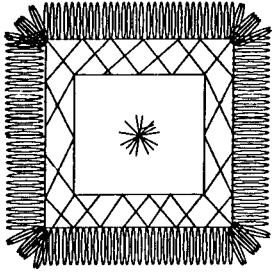

703033-01 Lounge  
accent pillow

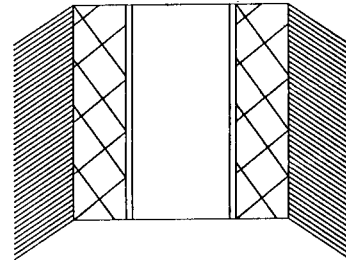

703033-02 Lounge  
accent pillow

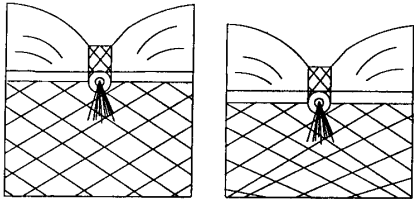

703033-03      703033-04(chair)  
Lounge accent pillows

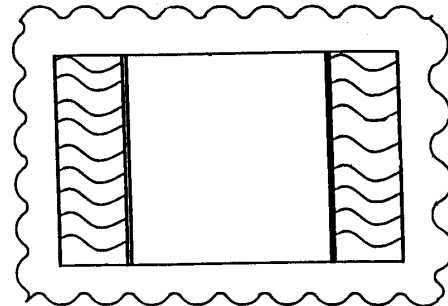

703033-05 Sham, Queen

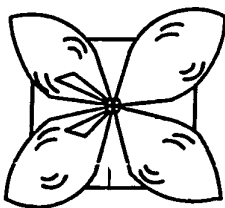

703033-06      Bedroom  
accent pillow

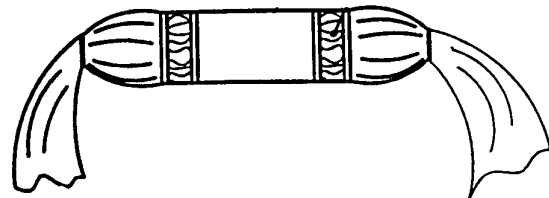

703033-07 Bedroom accent pillow

2001 350/355 LAND YACHT XL

UPHOLSTERY/FOAM/MATTRESS

PILLOW KIT- TROPICAL ISLE

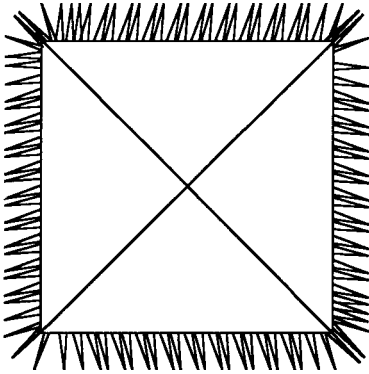

702978-01 Sofa pillow  
accent pillow

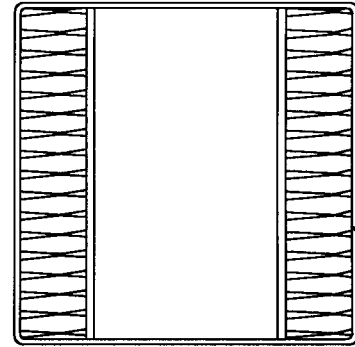

702978-02 Bedroom

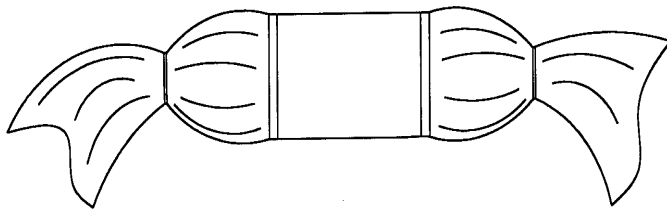

702978-03 Bedroom accent pillow

# 2001 350/355 LAND YACHT XL

## UPHOLSTERY/FOAM/MATTRESS

### PILLOW KIT- ROMAN SANDS

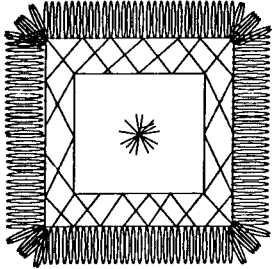

703032-01 Lounge accent pillow

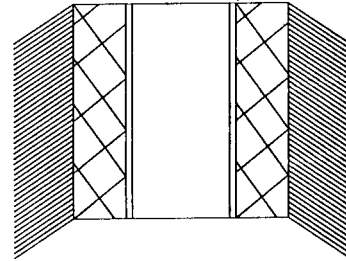

703032-02 Lounge accent pillow

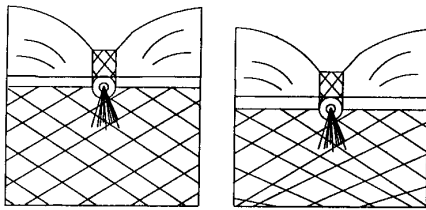

703032-03 703032-04(chair)  
Lounge accent pillows

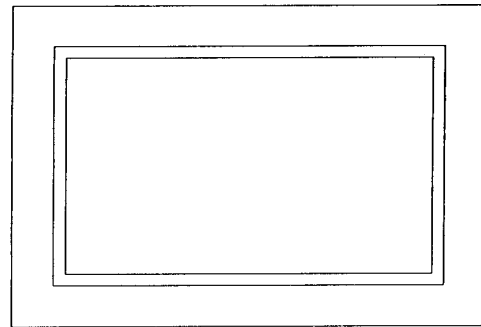

703032-05 Sham, Queen

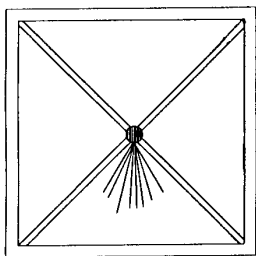

703032-06 Bedroom accent pillow

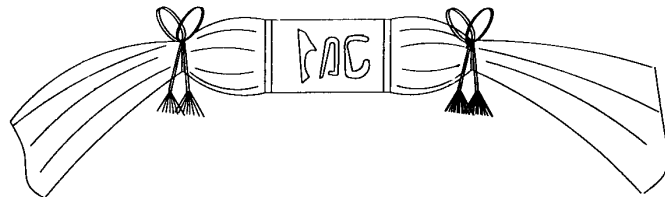

703032-07 Bedroom accent pillow

## 2001 350/355 LAND YACHT XL

### UPHOLSTERY/FOAM/MATTRESS

964537	Upholstered back, aft dinette
702464-17	Foam, dinette, upper back, RH, 32.25"
702464-06	Foam, dinette, lower back, 32.25"
964707	Upholstered back, forward dinette
702464-20	Foam, dinette, upper back, LH, 38.25"
702464-07	Foam, dinette, lower back, 38.25"
998070	Cover, seat, side dinette
702464-08	Foam, dinette, aft seat, 32.25"
702464-11	Foam, dinette, forward seat, 38.25"
998071	Cover, back, side dinette

## 2001 350/355 LAND YACHT XL

### VENTS/FANS

381207-02	Vent w/screen, refrigerator, roof
511152-01	Vent cover, exterior, range exhaust
381541-06	Roof vent w/power lift
381541-02	Switch, roof vent
381541-04	Trim ring, ceiling vent, Birch White
690266-01	Ventilator, round, bath
381153-01	Vent, Jensen #757
381450	Vent, roof, Fantastic#6000RBT
511376	Fan, defrost, oscillating
203148-01	Skylight, heavy duty, 14.5 x 22"
203148-02	Trim, inner skylight dome



## 2001 350/355 LAND YACHT XL

### WOOD/INTERIOR TRIM

801261	Paneling, interior wall, 1/8" x 4' x 8', Antiquity Buff
203159-02	Trim, divider bar, interior panels, Antiquity Buff
800507-01	Paneling, luan, 1/8" x 4' x 8'
800397-01	Cedar, planked, 5/32" x 4' x 8'
201728-01	Extrusion, ceiling trim retainer
201728-04	Extrusion, ceiling trim
801283	Paneling 1/2" x 4' x 8', G2S, Antiquity Buff
801274	Paneling 1/2" x 4' x 8', G1S, Antiquity Buff
801180-004	Paneling 1/2" x 4' x 7', G2S, Oak/Oak
801179-004	Paneling, 1/2" x 4' x 7', G1S, Oak/raw
801182-004	Paneling 5/32" x 4' x 7', G2S, Oak/Oak
801181-004	Paneling 5/32" x 4' x 7', G1S, Oak/raw
801284-004	Paneling 1/2" x 4' x 8', G2S, Oak/Antiquity Buff
801283	Paneling 1/2" x 4' x 8', G2S, Ant. Buff/Ant. Buff
801229	Laminate, Oak, 4' x 8'
365251-01	Tape, seam, Antiquity Buff, 1 1/8" wide
365251-02	Tape, seam, Antiquity Buff, 8" wide
365251-03	Tape, seam, Antiquity Buff, 12" wide
800631	Handrail, Oak, 23"
381670	Pole, fluted, wood, 1 3/8 x 6ft.
381449-04	Galley rail, decorative rod
381449-05	Post, decorative rail, brass

# 2001 350/355 LAND YACHT XL

## WOOD/INTERIOR



1) 801206-014



2) 964152-014

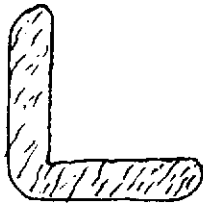

3) 801175-04



4) 800571-014

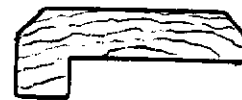

5) 800617-01



6) 801172-01

6a) 801172-03



7) 801173-03



8) 801173-04

1) 801206-01

2) 964152-014

3) 801175-04

4) 800571-014

5) 800617-01

6) 801172-01

6a) 801172-03

7) 801173-03

8) 801173-04

4Molding, floor, Oak, 43"

Molding, chair rail, Oak

Molding, corner, Antiquity Buff

Molding, Oak, flat 1/4" x 33/64" x 80"

Molding, Wainscoat, Oak

Molding, flexible corner, Oak

Molding, flexible corner, Solitude

Molding, flat radius, .88" Oak

Molding, flat radius, 1.13" Oak

(trim continued)

# 2001 350/355 LAND YACHT XL

## WOOD/INTERIOR TRIM

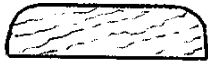

1) 800573-014



2) 800572-014



3) 201728-04

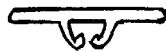

4) 201728-01



5) 203159-02

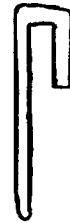

6) 201666

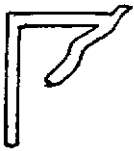

7) 201790-01  
8a) 203138-02  
8b) 203138-03

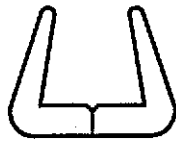

8) 203138-01



9) 964280-004

1) 800573-01  
2) 800572-014  
3) 201728-04  
4) 201728-01  
5) 203159-02  
6) 201666-01  
7) 201790-01  
8) 203138-01  
8a) 203138-02  
8b) 203138-03  
9) 964280-004

4Molding, door edge 1 3/32" x 80"  
Molding, panel edge, Oak 23/32" x 80"  
Extrusion, ceiling trim  
Extrusion, ceiling trim retainer  
Trim, divider bar, interior panels, Antiquity Buff  
Molding, J-3/16", plastic, almond  
Molding, cove, white, ceiling to wall  
Extrusion, wall, plastic, white (panel edging)  
Extrusion, wall, plastic, brown (panel edging)  
Extrusion, wall, plastic, beige (panel edging)  
Molding, counter top edge

## 2001 350/355 LAND YACHT XL

### WOOD/INTERIOR TRIM

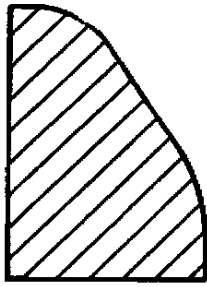

1) 800576-01



2) 801189



3) 964651

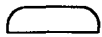

4) 801173-014

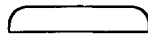

5) 801173-024

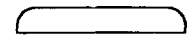

6) 801173-034

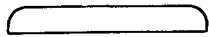

7) 801173-044

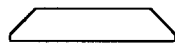

8) 801178-03

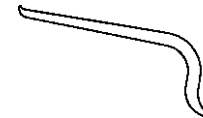

9) 203157

1) 800576-01

Molding, bath doorstop, Oak

2) 801189

Trim, bath doorjamb, Oak

3) 964651

Stile, bath hall

4) 801173-014

Flat molding, vinyl wrapped, Oak, .50 wide

5) 801173-024

Flat molding, vinyl wrapped, Oak, .75 wide

6) 801173-034

Flat molding, vinyl wrapped, Oak, .88 wide

7) 801173-044

Flat molding, vinyl wrapped, Oak, 1.13 wide

8) 801178-03

Flat molding, vinyl wrapped, Antiquity Buff

9) 203157

Molding, baseboard, plastic, almond

### SLIDE OUT ROOM INTERIOR TRIM

964267

Molding, decorative Oak, slide out trim, 84"

964101-024

Facia, decorative Oak, corner block, slide out

800572-014

Molding, panel edge, 23/32", Oak

# 2001 350/355 LAND YACHT XL

NOTES: