

TABLE OF CONTENTS

SECTION I SAFARI

A through C

APPLIANCES

Air Conditioner	I-1
Furnace	I-1
Microwave	I-1
Range	I-1
Refrigerator	I-1
Water Heater	I-1

BODY

End shell, aft	I-3
End shell, front	I-5
Roof	I-7
CS wall, 27ft	I-9
RS wall, 27ft	I-11
RS wall, 25 sleep six "C"	I-13
CS wall, 25 sleep six "C"	I-15
CS wall, 25 "A&B"	I-17
RS wall, 25 "A&B"	I-19
RS wall, 23 "C"	I-21
CS wall, 23 "C"	I-23
Body interior	I-24

CHASSIS

Axles	I-25
Shocks	I-25
Tire & wheel	I-25
Front Jack, Stabilizing jacks	I-25
Step	I-25
Rear bumper/hose carrier	I-25
Under belly metal	I-26
Coupler, hitch	I-26
Brakes, 12"	I-27

TABLE OF CONTENTS

SECTION II

D through E

[DECALS/EXTERIOR TRIM](#) II-1

DOORS/WINDOWS/AWNING

[Doors](#) II-2

[Windows](#) II-3

[Awning/rock guard](#) II-3

[DRAPES/BLINDS/VALANCES](#)..... II-4

ELECTRICAL

[110 volt](#) II-5

[12 volt](#)..... II-6

[Exterior light/reflectors](#) II-11

ENTERTAINMENT

[Radio/antenna](#) II-8

TABLE OF CONTENTS

SECTION III

F through H

FASTENERS (common fasteners available locally are not listed)

Rivets	III-1
------------------------------	-------

FLOOR COVERING

Carpet	III-3
Mats	III-3

FURNITURE

Interior doors	III-4
Mirrors	III-5
Drawer	III-5
Rear bedroom	III-6
Bath	III-7
Galley	III-10
Lounge	III-14

HARDWARE

Exterior locks/hinges	III-17
Interior drawer slides/hinges latches	III-21
Bath accessories	III-24
Awning hardware	III-26

TABLE OF CONTENTS

SECTION IV

L through Z

[LABELS and TAGS](#) IV-1

PLUMBING

[LPG](#) IV-2

[Fresh water](#) IV-3

[Drain water](#) IV-8

[Toilet](#) IV-12

[SAFETY EQUIPMENT](#) IV-14

[SEALER/GASKETS/PAINT](#) IV-15

[UPHOLSTERY/FOAM/MATTRESS](#) IV-16

[VENTS/FANS](#) IV-17

[WOOD/LAMINATES/TRIM](#) IV-18

SECTION I SAFARI
A through C

APPLIANCES

Air Conditioner	I-1
Furnace	I-1
Microwave	I-1
Range.....	I-1
Refrigerator	I-1
Water Heater	I-1

BODY

End shell, aft	I-3
End shell, front	I-5
Roof	I-7
CS wall, 27ft.....	I-9
RS wall, 27ft.....	I-11
RS wall, 25 sleep six "C"	I-13
CS wall, 25 sleep six "C"	I-15
CS wall, 25 "A&B"	I-17
RS wall, 25 "A&B"	I-19
RS wall, 23 "C"	I-21
CS wall, 23 "C"	I-23
Body interior.....	I-24

CHASSIS

Axles	I-25
Shocks.....	I-25
Tire & wheel	I-25
Jacks	I-25
Step	I-25
Rear bumper/hose carrier	I-25
Under belly metal	I-26
Coupler, hitch	I-26
Brakes, 12"	I-27

2001 SAFARI

APPLIANCES

195329-143	Air conditioner, 11, 000 Dometic
690323-02	Air conditioner, 13, 500 Dometic
201809	Pan, drain, air-conditioner
690323-03	Heat strip, Dometic air conditioner
690323-100	Shroud, exterior, Penquin
690323-05	Air box/return grill
690274-01	Furnace, Hydroflame, 8531-IV, 27ft. Safari
690274-04	Furnace, Hydroflame, 8525-IV, 23 & 25 ft
600247	Hose, 4", flex heat duct
600193	Hose, 2", flex heat duct
511228	Thermostat, furnace, off white
690407-01	Microwave, Dometic, black
690407-02	Trim kit, Dometic microwave, black
690345-01	Micro wave, convection, Sharp-opt.
690345-03	Trim ring, Sharp convection
690396-05	Range/oven, 22" Magic Chef
690396-03	Bifold cover
690388-01	Refrigerator, Dometic Americana, RM2852RH 27ft. Safari
964385-24	Door panel, refrigerator, 25.13" x 15.25"
690388	Refrigerator, Dometic, RM2652RH, 23 & 25ft. Safari
964385-13	Door panel, refrigerator, 25.13" x 17.50"
690199	Water heater, electronic ignition
091959	Switch package, water heater
690209	Access cover, brushed aluminum

2001 SAFARI

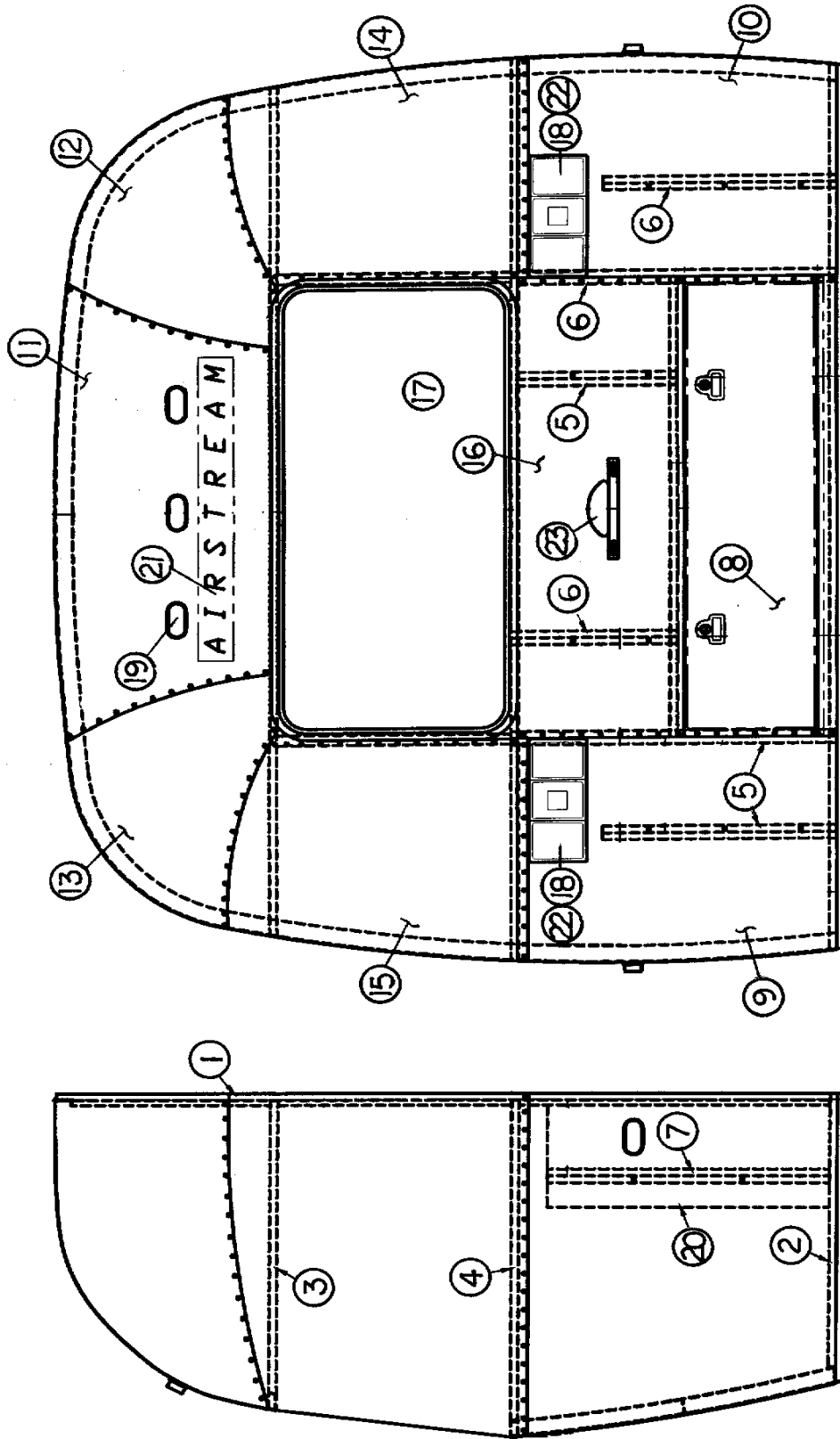

See next page for P/N

2001 SAFARI

BODY-AFT END

*27 & 25 FT A&B MODELS SHOWN

921180-04	End shell complete, 25 & 27ft."B"
921180-01	End shell complete, 25 & 27ft."A"
1) 114670	End bow
2) 114676	Floor bow
3) 114678	Upper window bow
4) 114677	Lower window bow
5) 114505-01	Support, lower end, LH
6) 114505-02	Support, lower end, RH
7) 101315	Brace, vertical rear
8) 921159-01	Trunk door assembly, twin bed only
9) 114895	Segment, #29
10) 114894	Segment, #28
11) 114893	Segment #25
12) 114890	Segment #26
13) 114891	Segment #27
14) 114889	Segment, center right
15) 114888	Segment, center left
16) NPN	Alum. sheet, .050" x 19" x 51" (cut from 114880-307)
17) 371362-06	Window, rear egress, 49.63" x 24.19"
18) 500500	Taillight complete
19) 510111	Clearance light, red
20) NPN	Alum. sheet, .040" x 12.0" x 29.0" (cut from 114880)
21) 385964-02	Decal, "AIRSTREAM", 32"
22) 201462	Pocket, ABS taillight
23) 500053	Light and license plate holder

*The 25 & 23 ft. corner bed models have a different rear window and a smaller rear access door.

371362-09	Window, rear egress, Safari "C"
100679-01	Access door assembly, rear, Safari "C"

2001 SAFARI

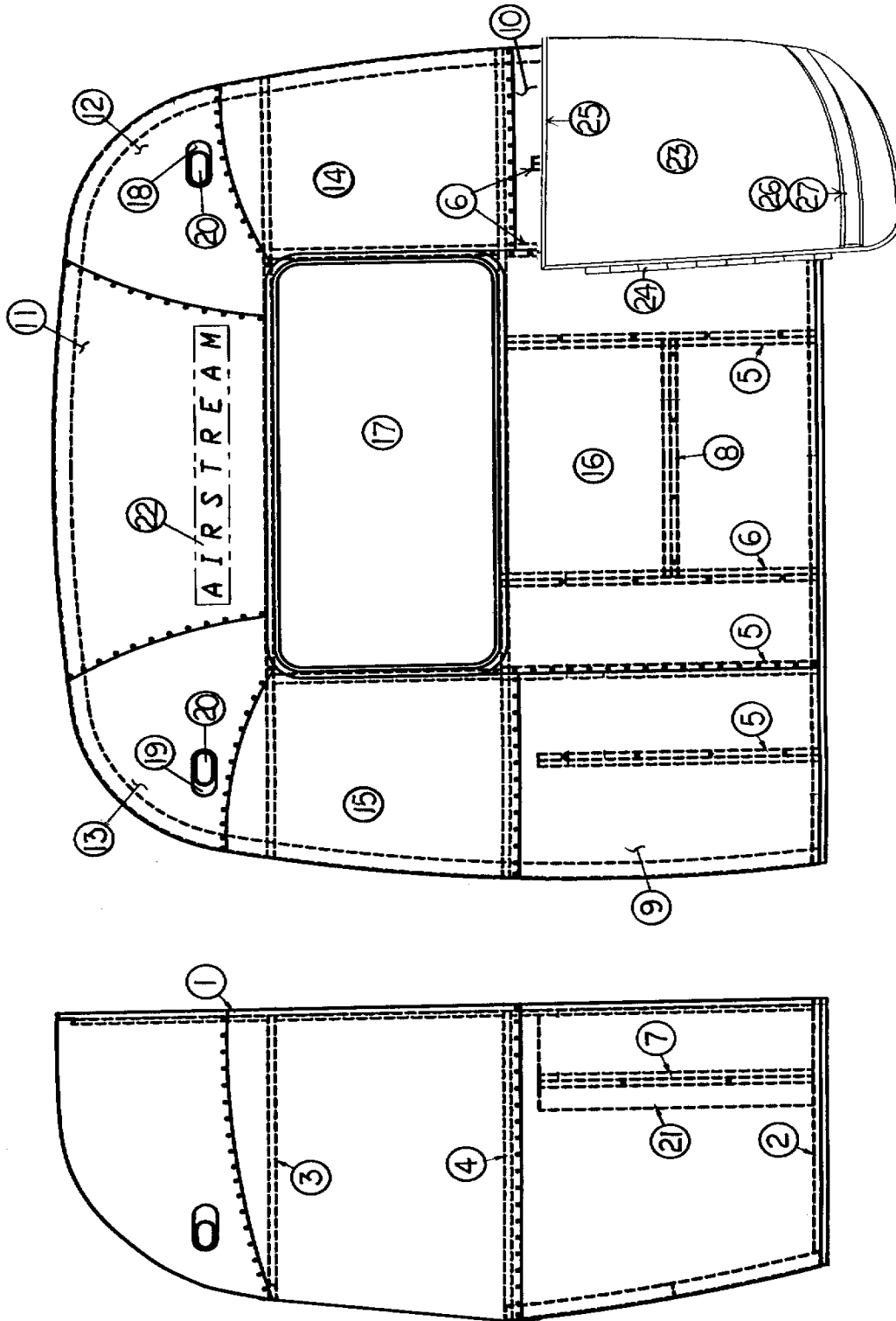

See next page for P/N

2001 SAFARI BODY-FRONT END

921179 End shell complete

- | | |
|-----------------|---|
| 1) 114670 | End bow |
| 2) 114676 | Floor bow |
| 3) 114678 | Upper window bow |
| 4) 114677 | Lower window bow |
| 5) 114505-01 | Support, lower end, LH |
| 6) 114505-02 | Support, lower end, RH |
| 7) 101315 | Brace, vertical rear |
| 8) 104408 | Extrusion rib |
| 9) 114895 | Segment #29 |
| 10) 114894 | Segment #28 |
| 11) 114893 | Segment #25 |
| 12) 114890 | Segment #26 |
| 13) 114891 | Segment #27 |
| 14) 114889 | Segment, center right |
| 15) 114888 | Segment, center left |
| 16) NPN | Alum. sheet, .050x19.0x51.0 (cut from 114880-307) |
| 17) 371362-05 | Window, 49.63 x 24.19", Safari |
| 18) 101177 | Base , lamp, cast polished, RS |
| 19) 101178 | Base, lamp, cast polished, CS |
| 20) 510112 | Clearance light, amber |
| 21)) NPN | Alum. sheet, .040x12.0x29.0 (cut from 114880) |
| 22) 385964-02 | Decal "AIRSTREAM" 32" |
| 23) 685366-100 | Wrap protector, RS, Safari/Bambi |
| 23a) 685365-100 | Wrap protector, CS, Safari/Bambi |
| 24) 381605-01 | Hinge, stainless, wrap protector |
| 25) 100742-01 | Extrusion, mirror/wrap protector trim |
| 26) 114460 | Extrusion, rub rail |
| 27) 201763-02 | Insert, rub rail, black |

2001 SAFARI

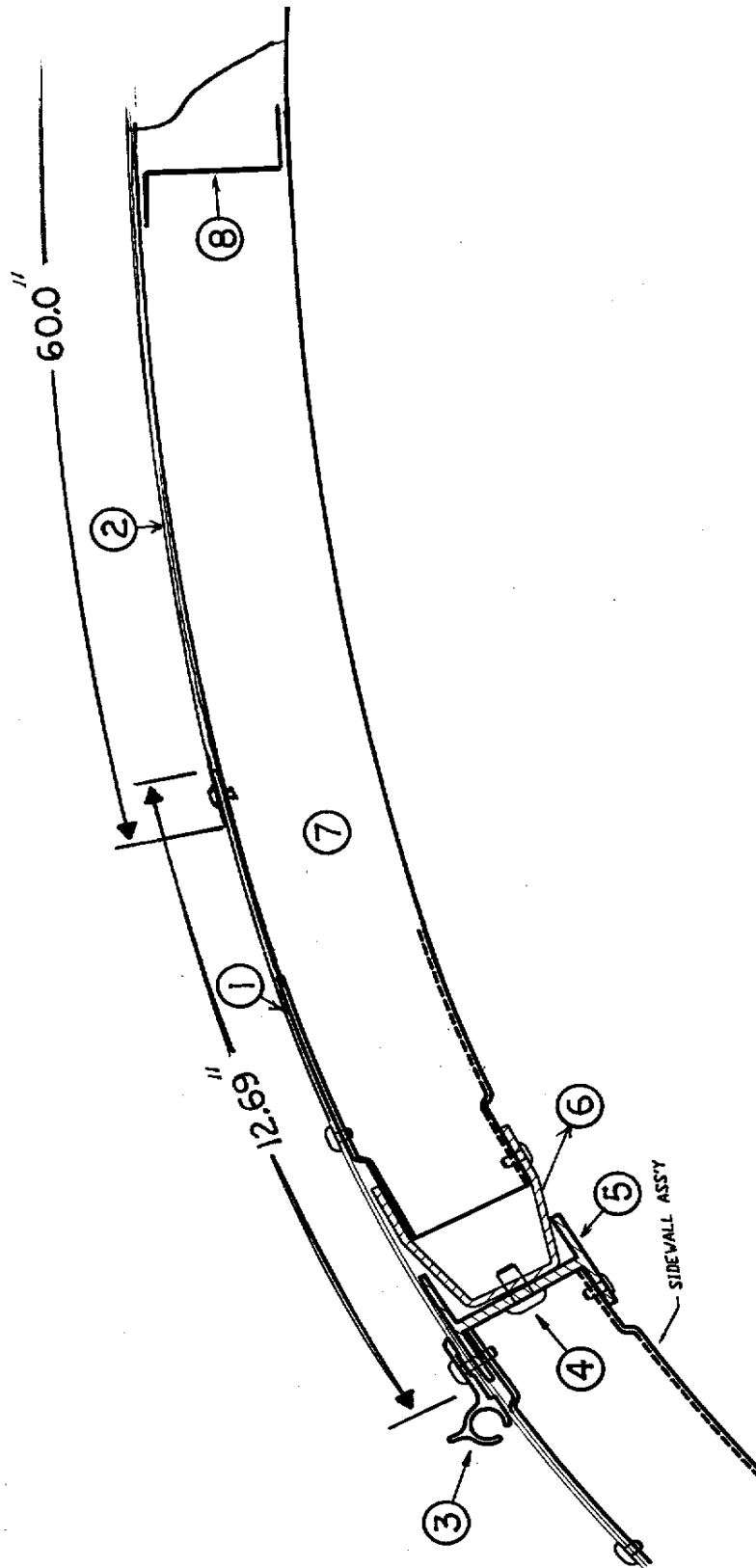

See next page for P/N

2001 SAFARI

BODY

ROOF-END VIEW

- | | |
|----------------|---|
| 1) 114669-307 | Alum. sheet, white, .032" x 12.69" x 307" |
| 2) 114489-262 | Alum. sheet, white, .032" x 60.0" x 262", 27ft. |
| 2a) 114489-198 | Alum. sheet, white, .032" x 60" x 198", 23, 25ft. |
| 3) 114290 | Extrusion, awning/drip rail |
| 4) 340123-02 | Rivet, Huck, 3/16" x 1/2" |
| 5) 104707-05 | Extrusion, "I" beam |
| 6) 114987-01 | Extrusion, roof corner, 194" |
| 6a) 114987-02 | Extrusion, roof corner, 258" |
| 7) 114668 | Roof bow |
| 8) 104408 | Extrusion, Z-bar, horizontal |

Not shown:

104948 Air deflector, between roof A/C. and refrigerator

2001 SAFARI

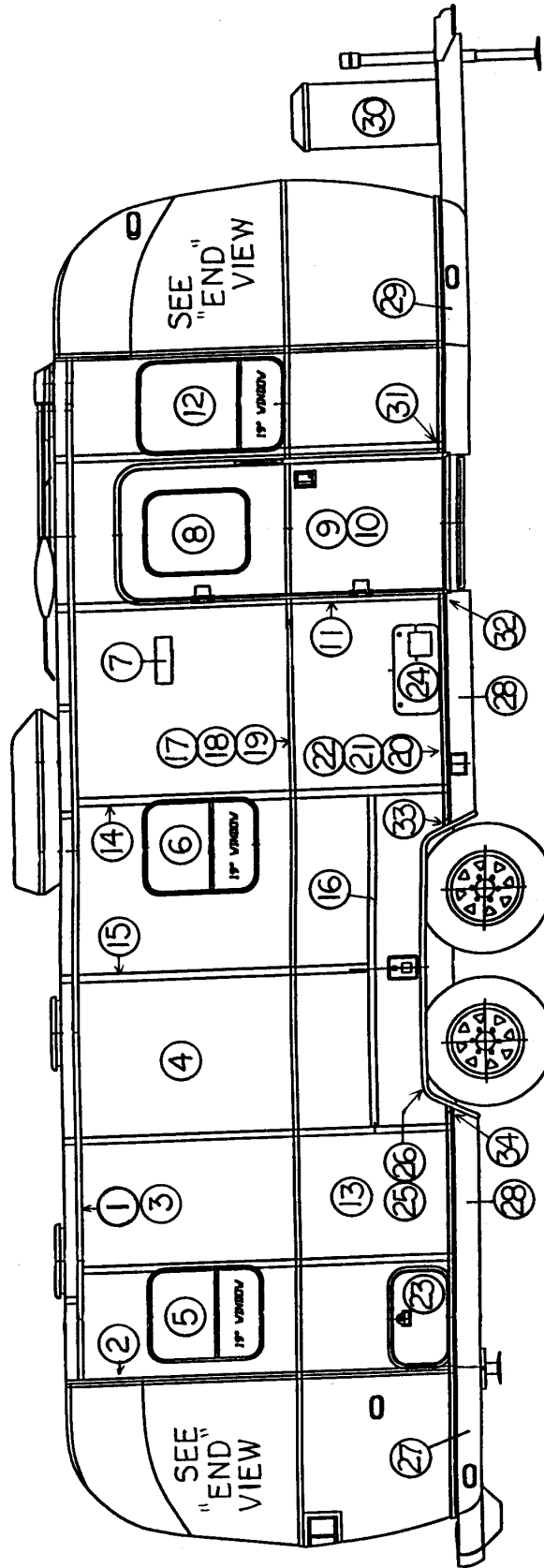

See next page for P/N

2001 SAFARI

BODY-27FT SAFARI, CS

(Hardware such as hinges, locks and latches are located in the **hardware** section of this book)

- 1) 114290 Extrusion, awning/drip rail
- 2) 114670 Rib, end bow
- 3) 104707-05 Extrusion, "I" beam
- 4) 114880-262 Aluminum sheet, upper, .040" x 51" x 262"
- 5) 371362-02 Window, 19.25" x 22.75"
- 6) 371362-02 Window, 19.25" x 22.75"
- 7) 511017-11 Vent cover, range exhaust
- 8) 371362-01 Window, main door, 17.75" x 21.25"
- 9) 110067-07 Main door assembly
- 10) 114654 Screen door assembly
- 11) 114652 Jamb, main door
- 12) 371362-07 Window, 19.25" x 29.75"
- 13) 114879-262 Aluminum sheet, lower, .040" x 33" x 262"
- 14) 114387-01 Bow, Z rib, RH
- 15) 114387-02 Bow, Z rib, LH
- 16) 100986 Wheel well stiffener(floor channel)
- 17) 114328 Extrusion, belt line
- 18) 201912 Molding, chrome, belt line
- 19) 100034 "Z" bar, 48"
- 20) 114460 Extrusion, rub rail
- 21) 201763-01 Insert, rub rail, chrome, 1"
- 22) 100986 Floor channel
- 23) 100679-01 Access door w/jamb
- 24) 670274-06 Cover, Hydroflame furnace
- 25) 684936 Wheel well trim, inner, tandem axle
- 26) 684937 Wheel well trim, outer, tandem axle
- 27) 200545 Banana wrap, CS rear
- 28) 101131-01 Underbelly wrap, .024" x 22.5", Pewter
- 29) 200543 Banana wrap, CS front
- 30) 104264-01 Cover, 30# LPG bottles w/o decal
- 31) 114465-01 Casting, rub rail end, door, RH
- 32) 114465-02 Casting, rub rail end, door, LH
- 33) 114466-01 Casting, rub rail end, wheel well, RH
- 34) 114466-02 Casting, rub rail end, wheel well, LH

2001 SAFARI

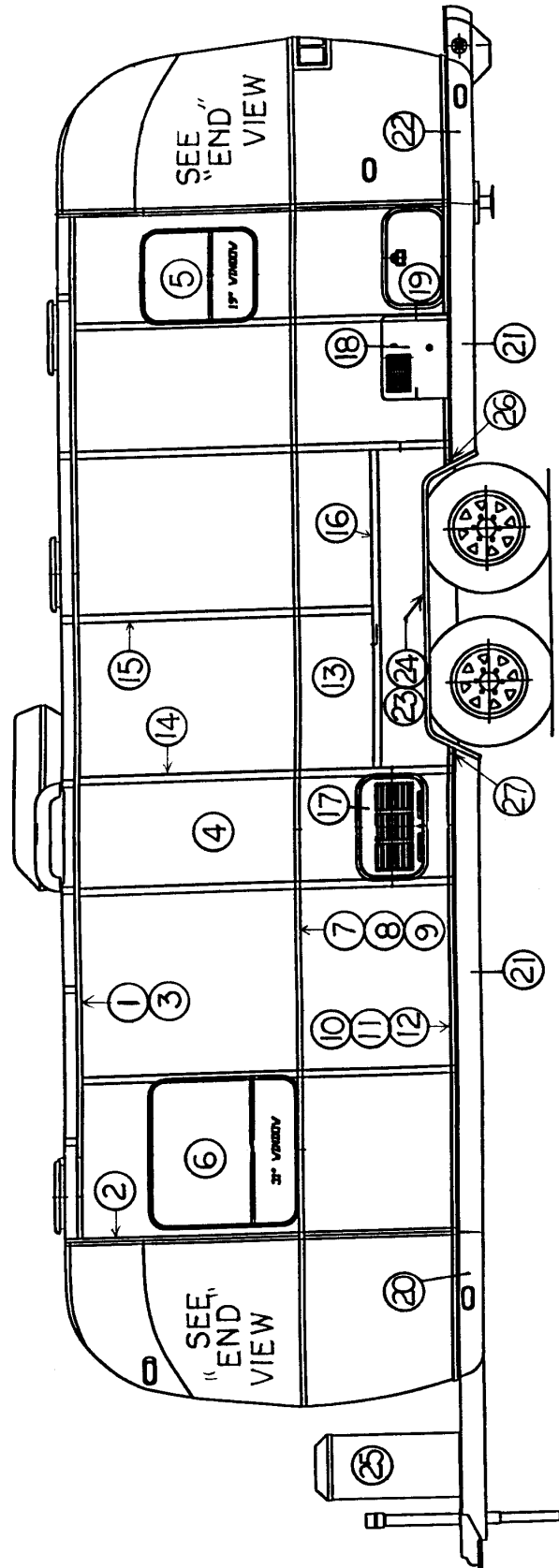

See next page for P/N

2001 SAFARI

BODY-27FT SAFARI, RS

(Hardware such as hinges, locks and latches are located in the **hardware** section of this book)

- 1) 114290 Extrusion, awning/drip rail
- 2) 114670 Rib, end bow
- 3) 104707-05 Extrusion, "I" beam
- 4) 114880-262 Aluminum sheet, upper, .040" x 51" x 262"
- 5) 371362-02 Window, 19.25" x 22.75"
- 6) 371362-08 Window, 31.25" X 29.75"
- 7) 114328 Extrusion, belt line
- 8) 201912 Molding, chrome, belt line
- 9) 100034 "Z" bar, 48"
- 10) 114460 Extrusion, rub rail
- 11) 201763-01 Insert, rub rail, chrome, 1"
- 12) 100986 Floor channel
- 13) 114879-262 Aluminum sheet, lower, .040" x 33" x 262"
- 14) 114387-01 Bow, Z rib, RH
- 15) 114387-02 Bow, Z rib, LH
- 16) 100986 Wheel well stiffener(floor channel)
- 17) 922243 Door, refrigerator access
- 18) 690209 Access cover, Atwood
- 19) 100679-01 Access door w/jamb
- 20) 200542 Banana wrap, RS front
- 21) 101131-01 Underbelly wrap, .024" x 22.5", Pewter
- 22) 200544 Banana wrap, RS rear
- 23) 684936 Wheel well trim, inner, tandem axle
- 24) 684937 Wheel well trim, outer, tandem axle
- 25) 104264-01 Cover, 30# LPG bottles w/o decal
- 26) 114466-01 Casting, rub rail end, wheel well, RH
- 27) 114466-02 Casting, rub rail end, wheel well, LH

2001 SAFARI

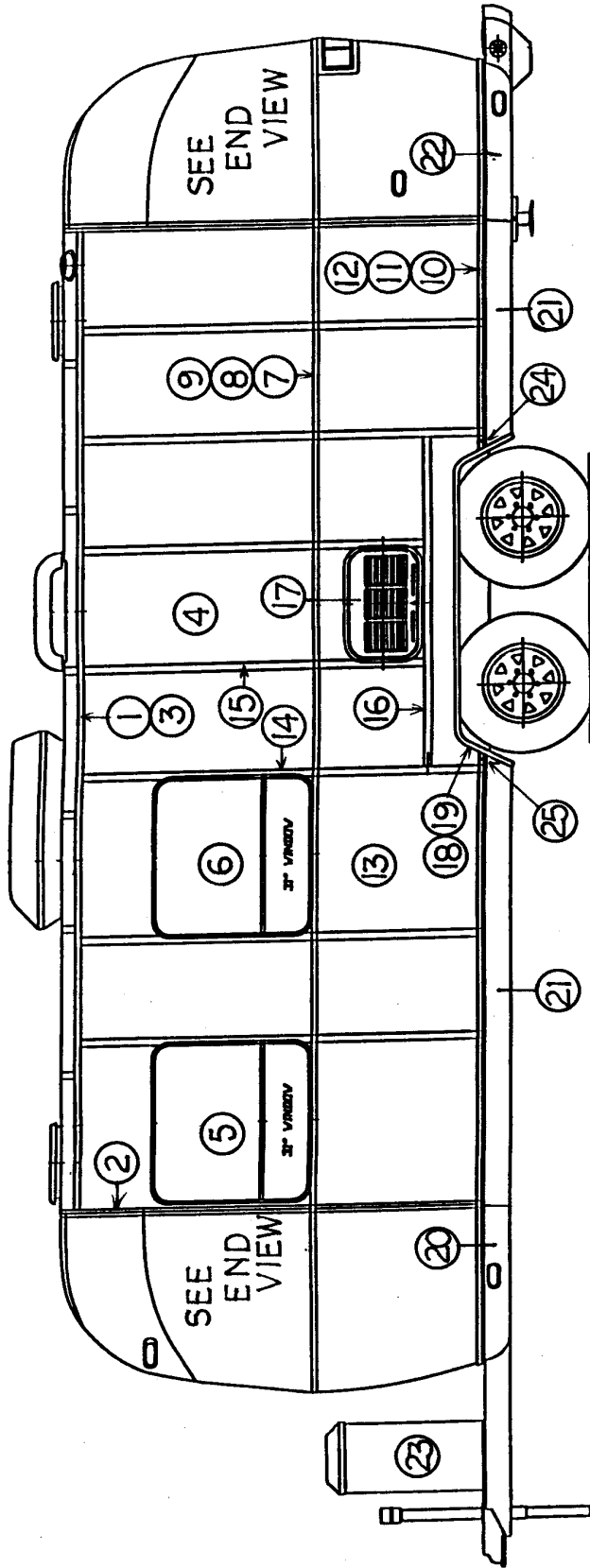

See next page for P/N

2001 SAFARI

BODY-25FT, SLEEP 6 SAFARI, RS

(Hardware such as hinges, locks and latches are located in the **hardware** section of this book)

- 1) 114290 Extrusion, awning/drip rail
- 2) 114670 Rib, end bow
- 3) 104707-05 Extrusion, "I" beam
- 4) 114880-198 Aluminum sheet, upper, .040" x 51" x 198"
- 5) 371362-08 Window, 31.25" x 29.75"
- 6) 371362-08 Window, 31.25" X 29.75"
- 7) 114328 Extrusion, belt line
- 8) 201912 Molding, chrome, belt line
- 9) 100034 "Z" bar, 48"
- 10) 114460 Extrusion, rub rail
- 11) 201763-01 Insert, rub rail, chrome, 1"
- 12) 100986 Floor channel
- 13) 114879-198 Aluminum sheet, lower, .040" x 33" x 198"
- 14) 114387-01 Bow, Z rib, RH
- 15) 114387-02 Bow, Z rib, LH
- 16) 100986 Wheel well stiffener(floor channel)
- 17) 922243 Door, refrigerator access
- 18) 684936 Wheel well trim, inner, tandem axle
- 19) 684937 Wheel well trim, outer, tandem axle
- 20) 200542 Banana wrap, RS front
- 21) 101131-01 Underbelly wrap, .024" x 22.5", Pewter
- 22) 200544 Banana wrap, RS rear
- 23) 104264-01 Cover, 30# LPG bottles w/o decal
- 24) 114466-01 Casting, rub rail end, wheel well, RH
- 25) 114466-02 Casting, rub rail end, wheel well, LH

2001 SAFARI

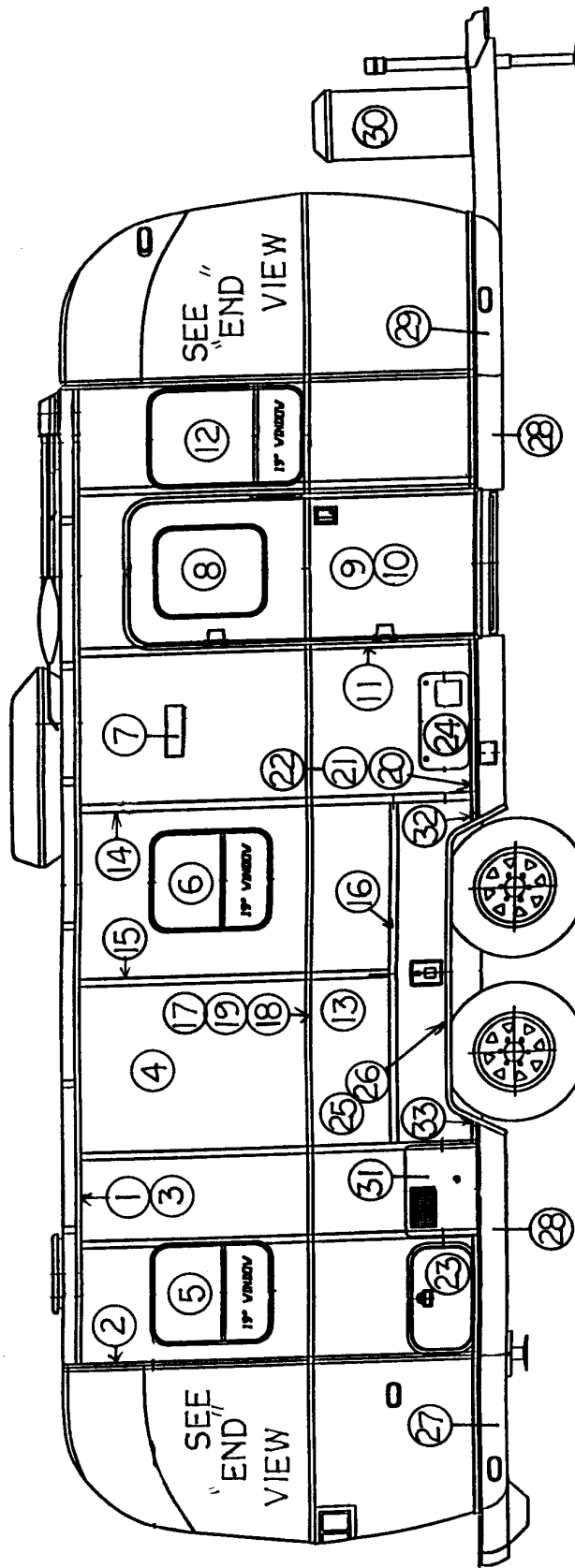

See next page for P/N

2001 SAFARI

BODY-25FT, SLEEP 6 SAFARI, CS

(Hardware such as hinges, locks and latches are located in the **hardware** section of this book)

- 1) 114290 Extrusion, awning/drip rail
- 2) 114670 Rib, end bow
- 3) 104707-05 Extrusion, "I" beam
- 4) 114880-198 Aluminum sheet, upper, .040" x 51" x 198"
- 5) 371362-02 Window, 19.25" x 22.75"
- 6) 371362-02 Window, 19.25" x 22.75"
- 7) 511017-11 Vent cover, range exhaust
- 8) 371362-01 Window, main door, 17.75" x 21.25"
- 9) 110067-07 Main door assembly
- 10) 114654 Screen door assembly
- 11) 114652 Jamb, main door
- 12) 371362-07 Window, 19.25" x 29.75"
- 13) 114879-198 Aluminum sheet, lower, .040" x 33 x 198"
- 14) 114387-01 Bow, Z rib, RH
- 15) 114387-02 Bow, Z rib, LH
- 16) 100986 Wheel well stiffener(floor channel)
- 17) 114328 Extrusion, belt line
- 18) 201912 Molding, chrome, belt line
- 19) 100034 "Z" bar, 48"
- 20) 114460 Extrusion, rub rail
- 21) 201763-01 Insert, rub rail, chrome, 1"
- 22) 100986 Floor channel
- 23) 100679-01 Access door w/jamb
- 24) 670274-06 Cover, Hydroflame furnace
- 25) 684936 Wheel well trim, inner, tandem axle
- 26) 684937 Wheel well trim, outer, tandem axle
- 27) 200545 Banana wrap, CS rear
- 28) 101131-01 Underbelly wrap, .024" x 22.5, Pewter
- 29) 200543 Banana wrap, CS front
- 30) 104264-01 Cover, 30# LPG bottles w/o decal
- 31) 690209 Access cover, Atwood
- 32) 114466-01 Casting, rub rail end, wheel well, RH
- 33) 114466-02 Casting, rub rail end, wheel well, LH

2001 SAFARI

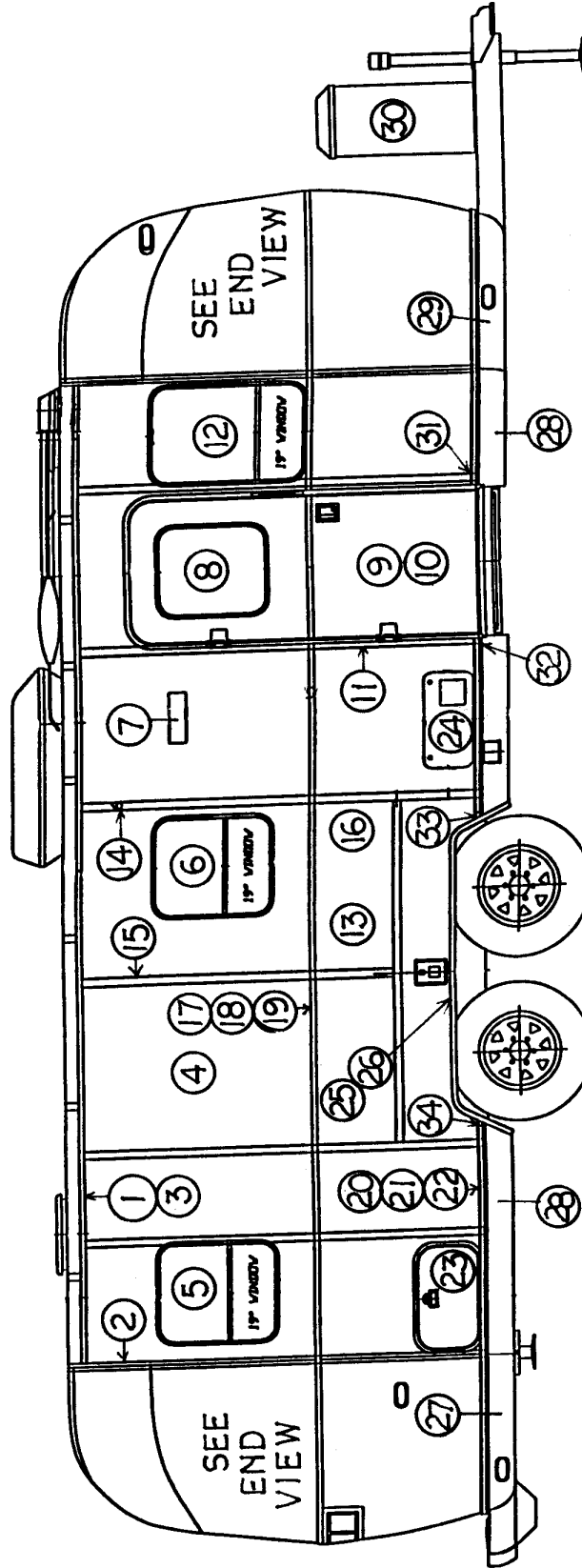

See next page for P/N

2001 SAFARI

BODY-25FT, SAFARI, CS

(Hardware such as hinges, locks and latches are located in the **hardware** section of this book)

- 1) 114290 Extrusion, awning/drip rail
- 2) 114670 Rib, end bow
- 3) 104707-05 Extrusion, "I" beam
- 4) 114880-198 Aluminum sheet, upper, .040" x 51" x 198"
- 5) 371362-02 Window, 19.25" x 22.75"
- 6) 371362-02 Window, 19.25" x 22.75"
- 7) 511017-11 Vent cover, range exhaust
- 8) 371362-01 Window, main door, 17.75" x 21.25"
- 9) 110067-07 Main door assembly
- 10) 114654 Screen door assembly
- 11) 114652 Jamb, main door
- 12) 371362-07 Window, 19.25" x 29.75"
- 13) 114879-198 Aluminum sheet, lower, .040" x 33" x 198"
- 14) 114387-01 Bow, Z rib, RH
- 15) 114387-02 Bow, Z rib, LH
- 16) 100986 Wheel well stiffener(floor channel)
- 17) 114328 Extrusion, belt line
- 18) 201912 Molding, chrome, belt line
- 19) 100034 "Z" bar, 48"
- 20) 114460 Extrusion, rub rail
- 21) 201763-01 Insert, rub rail, chrome, 1"
- 22) 100986 Floor channel
- 23) 100679-01 Access door w/jamb
- 24) 670274-06 Cover, Hydroflame furnace
- 25) 684936 Wheel well trim, inner, tandem axle
- 26) 684937 Wheel well trim, outer, tandem axle
- 27) 200545 Banana wrap, CS rear
- 28) 101131-01 Underbelly wrap, .024" x 22.5", Pewter
- 29) 200543 Banana wrap, CS front
- 30) 104264-01 Cover, 30# LPG bottles w/o decal
- 31) 114465-01 Casting, rub rail end, door, RH
- 32) 114465-02 Casting, rub rail end, door, LH
- 33) 114466-01 Casting, rub rail end, wheel well, RH
- 34) 114466-02 Casting rub rail end, wheel well, LH

2001 SAFARI

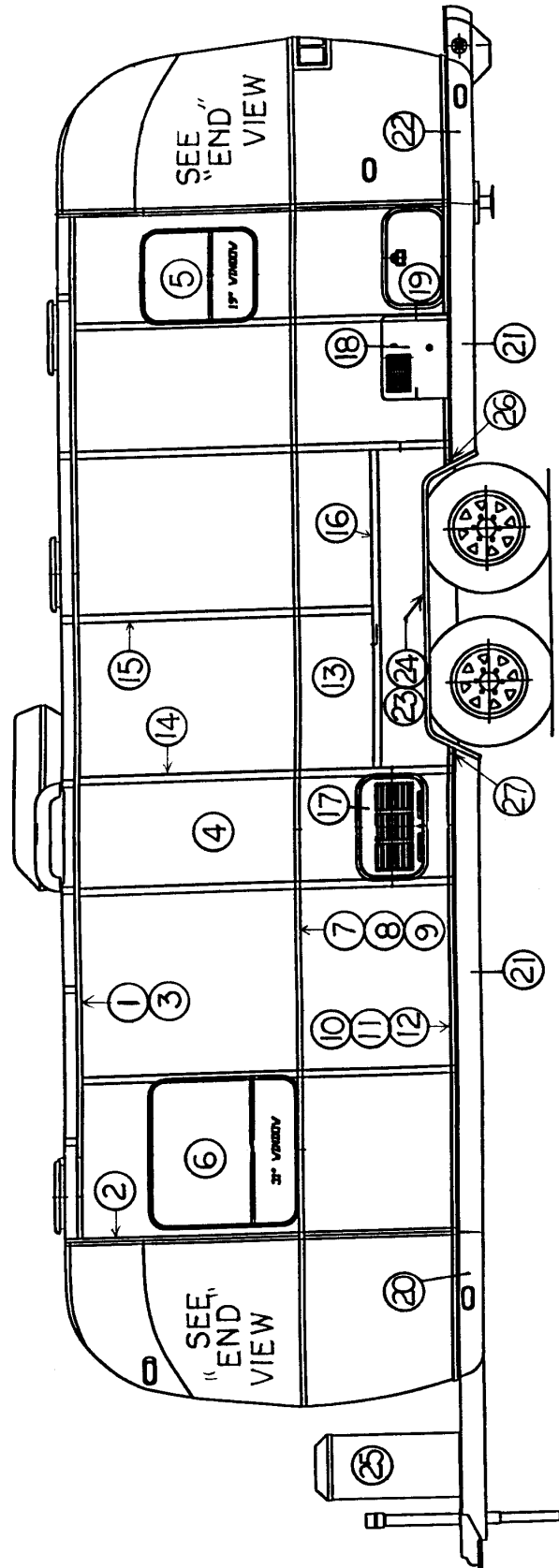

See next page for P/N

2001 SAFARI

BODY-25FT SAFARI, RS

(Hardware such as hinges, locks and latches are located in the **hardware** section of this book)

- | | |
|----------------|---|
| 1) 114290 | Extrusion, awning/drip rail |
| 2) 114670 | Rib, end bow |
| 3) 104707-05 | Extrusion, "I" beam |
| 4) 114880-198 | Aluminum sheet, upper, .040" x 51" x 198" |
| 5) 371362-02 | Window, 19.25" x 22.75" |
| 6) 371362-08 | Window, 31.25" X 29.75" |
| 7) 114328 | Extrusion, belt line |
| 8) 201912 | Molding, chrome, belt line |
| 9) 100034 | "Z" bar, 48" |
| 10) 114460 | Extrusion, rub rail |
| 11) 201763-01 | Insert, rub rail, chrome, 1" |
| 12) 100986 | Floor channel |
| 13) 114879-198 | Aluminum sheet, lower, .040" x 33" x 198" |
| 14) 114387-01 | Bow, Z rib, RH |
| 15) 114387-02 | Bow, Z rib, LH |
| 16) 100986 | Wheel well stiffener(floor channel) |
| 17) 922243 | Door, refrigerator access |
| 18) 690209 | Access door, Atwood |
| 19) 100679 | Access door w/jamb |
| 20) 200542 | Banana wrap, RS front |
| 21) 101131-01 | Underbelly wrap, .024 x 22.5, Pewter |
| 22) 200544 | Banana wrap, RS rear |
| 23) 684936 | Wheel well trim, inner, tandem axle |
| 24) 684937 | Wheel well trim, outer, tandem axle |
| 25) 104264-01 | Cover, 30# LPG bottles w/o decal |
| 26) 114466-01 | Casting, rub rail end, wheel well, RH |
| 27) 114466-02 | Casting, rub rail end, wheel well, LH |

2001 SAFARI

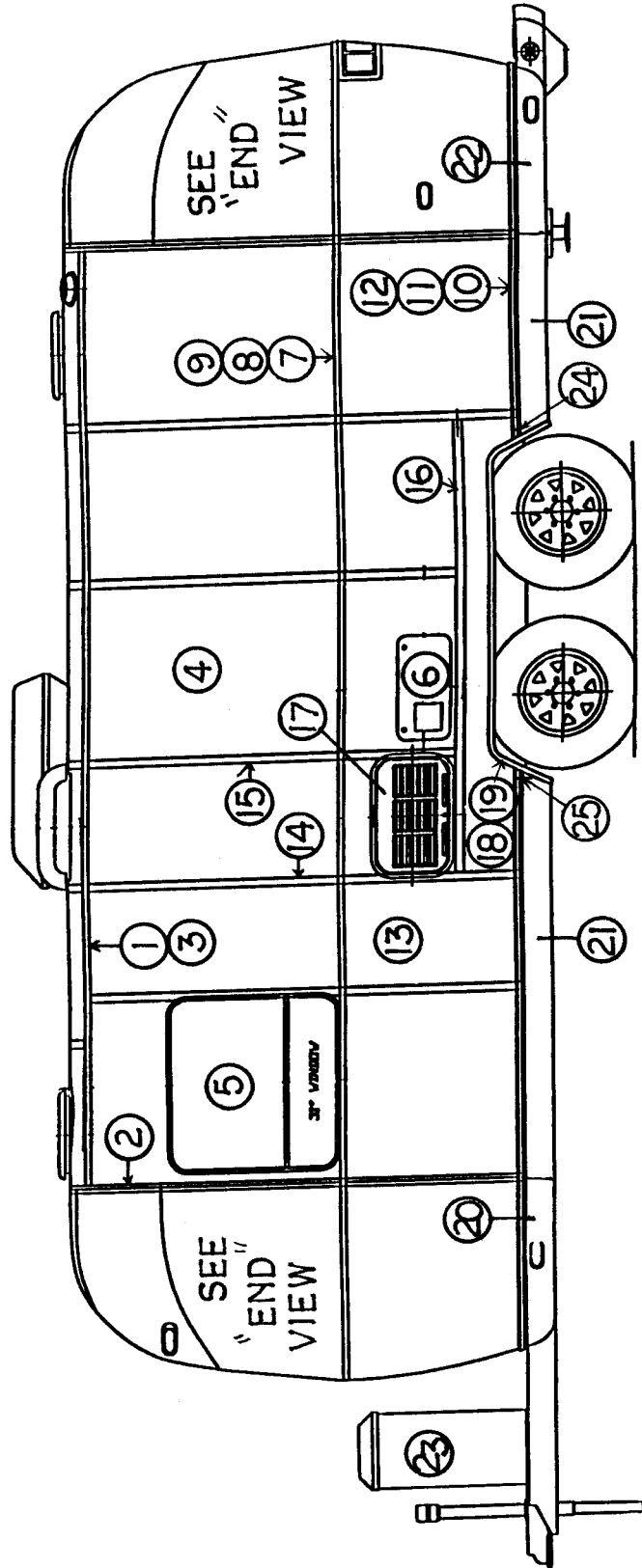

See next page for P/N

2001 SAFARI

BODY-23FT, SAFARI, RS

(Hardware such as hinges, locks and latches are located in the **hardware** section of this book)

- | | |
|----------------|---|
| 1) 114290 | Extrusion, awning/drip rail |
| 2) 114670 | Rib, end bow |
| 3) 104707-05 | Extrusion, "I" beam |
| 4) 114880-198 | Aluminum sheet, upper, .040" x 51" x 198" |
| 5) 371362-08 | Window, 31.25" x 29.75" |
| 6) 670274-06 | Cover, Hydroflame furnace |
| 7) 114328 | Extrusion, belt line |
| 8) 201912 | Molding, chrome, belt line |
| 9) 100034 | "Z" bar, 48" |
| 10) 114460 | Extrusion, rub rail |
| 11) 201763-01 | Insert, rub rail, chrome, 1" |
| 12) 100986 | Floor channel |
| 13) 114879-198 | Aluminum sheet, lower, .040" x 33" x 198" |
| 14) 114387-01 | Bow, Z rib, RH |
| 15) 114387-02 | Bow, Z rib, LH |
| 16) 100986 | Wheel well stiffener(floor channel) |
| 17) 922243 | Door, refrigerator access |
| 18) 964936 | Wheel well trim, inner, tandem axle |
| 19) 684937 | Wheel well trim, outer, tandem axle |
| 20) 200542 | Banana wrap, RS front |
| 21) 101131-01 | Underbelly wrap, .024" x 22.5", Pewter |
| 22) 200544 | Banana wrap, RS rear |
| 23) 104264 | Cover, 30# LPG bottles w/o decal |
| 24) 114466-01 | Casting, rub rail end, wheel well, RH |
| 25) 114466-02 | Casting, rub rail end, wheel well, LH |

2001 SAFARI

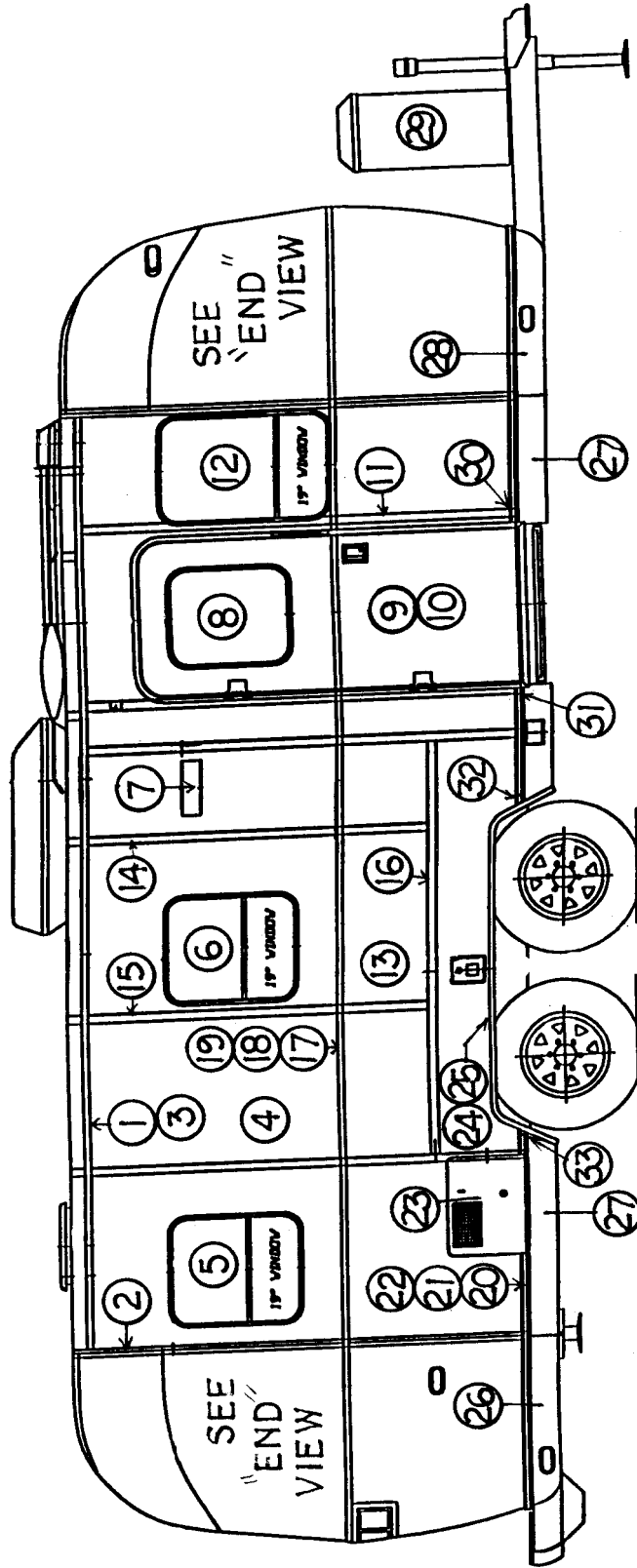

See next page for P/N

2001 SAFARI

BODY-23FT, SAFARI, CS

(Hardware such as hinges, locks and latches are located in the **hardware** section of this book)

- 1) 114290 Extrusion, awning/drip rail
- 2) 114670 Rib, end bow
- 3) 104707-05 Extrusion, "I" beam
- 4) 114880-198 Aluminum sheet, upper, .040" x 51" x 198"
- 5) 371362-02 Window, 19.25" x 22.75"
- 6) 371362-02 Window, 19.25" x 22.75"
- 7) 511017-11 Vent cover, range exhaust
- 8) 371362-01 Window, main door, 17.75" x 21.25"
- 9) 110067-01 Main door assembly
- 10) 114654 Screen door assembly
- 11) 114652 Jamb, main door
- 12) 371362-07 Window, 19.25" x 29.75"
- 13) 114879-198 Aluminum sheet, lower, .040" x 33 x 198"
- 14) 114387-01 Bow, Z rib, RH
- 15) 114387-02 Bow, Z rib, LH
- 16) 100986 Wheel well stiffener(floor channel)
- 17) 114328 Extrusion, belt line
- 18) 201912 Molding, chrome, belt line
- 19) 100034 "Z" bar, 48"
- 20) 114460 Extrusion, rub rail
- 21) 201763-01 Insert, rub rail, chrome, 1"
- 22) 100986 Floor channel
- 23) 690209 Access cover, Atwood
- 24) 684936 Wheel well trim, inner, tandem axle
- 25) 684937 Wheel well trim, outer, tandem axle
- 26) 200545 Banana wrap, CS rear
- 27) 101131-01 Underbelly wrap, .024" x 22.5", Pewter
- 28) 200543 Banana wrap, CS front
- 29) 104264-01 Cover, 30# LPG bottles w/o decal
- 30) 114465-01 Casting, rib rail end, door, RH
- 31) 114465-02 Casting, rub rail end, door, LH
- 32) 114466-01 Casting, rub rail end, wheel well, RH
- 33) 114466-02 Casting, rub rail end, wheel well, LH

2001 SAFARI

BODY INTERIOR

964137-02	Roof locker & aft end liner, 25 & 27ft.-A&B
964523	Roof locker & aft end liner, 23 & 25ft.-"C"
964137-01	Roof locker & forward end liner, all Safari
114445	Aluminum sheet, .032" x 34" x coil
114853-01	Aluminum sheet, .032" x 57" x coil
702482-02*	Head liner, Dundee Chalk
702482-03*	Head liner, Spectra Opal
702481 *	Wall liner, Geometric Pearl
114157-01	Extrusion, end liner, upper, white
201728-01	Extrusion, ceiling trim retainer
201728-03	Extrusion, ceiling trim
203225	Trim, flexible, "U", white
203138-01	Extrusion, plastic, wall, white
203138-02	Extrusion, plastic, wall, brown
101077	Extrusion, main doorjamb trim, interior
110460-01	Trim ring, window, 17.75" X 21.25"
110460-02	Trim ring, window, 19.25" x 22.75"
110460-06	Trim ring, window, 19.25" x 29.75"
110460-07	Trim ring, window, 31.25" x 29.75"
110460-05	Trim ring, window, 49.63" x 24.19"
110521-01	Trim ring, window, rear egress, 23 "C"
110521	Trim ring, window, rear egress, 25 "C"
200514	Wheel well insulator, tandem

* For repairs purchase vinyl glues locally.

2001 SAFARI

CHASSIS

7350475H	Axle, 3500#-27ft.
7300253	Axle, 3000#-23 & 25ft.
0220003	Shock absorber
0250173-15	Bolt, grade 5, 5/8"-18 x 1.5", shock mount
0130068-818	Nut, hex head flanged, 5/8"-18, shock mount
410843	Tire and wheel assembly, 15", BSW
410834-100	Wheel, aluminum, 15 x 6, Safari/Bambi
400844	Dust cover, center hub
400923	Acorn lug nut
200844	Wheel well, tandem
3320028	Jack, front, Atwood
453570	Stabilizer plate, front jack
410598	Foot pad
381416	Step, single, Elkhart #124
410831	Rear bumper, Safari
453497	Lid, rear hose carrier
453538	Bottom, rear hose carrier
380024	Support arm, hose carrier lid
380067	Hose carrier lid latch(Cam-o-lock)
381435	Hatch, access cover, 4", white(power cord)
601544	E-Z Hose carrier, 46in.
400914-03	Stabilizer jack, rear, 20" RLC 3/22/01
400914-02	Handle, rear stabilizer jack

(continued)

2001 SAFARI CHASSIS

0300027 0360254H	Break away switch, Bargman Bracket, breakaway switch
601642 453493	Pan, tank support, Roto cast Hanger strap, tank pan
114679 101131-01	Aluminum underbelly, .019" x 65.75 x coil Aluminum, underbelly wrap, .024" x 22.5, gray

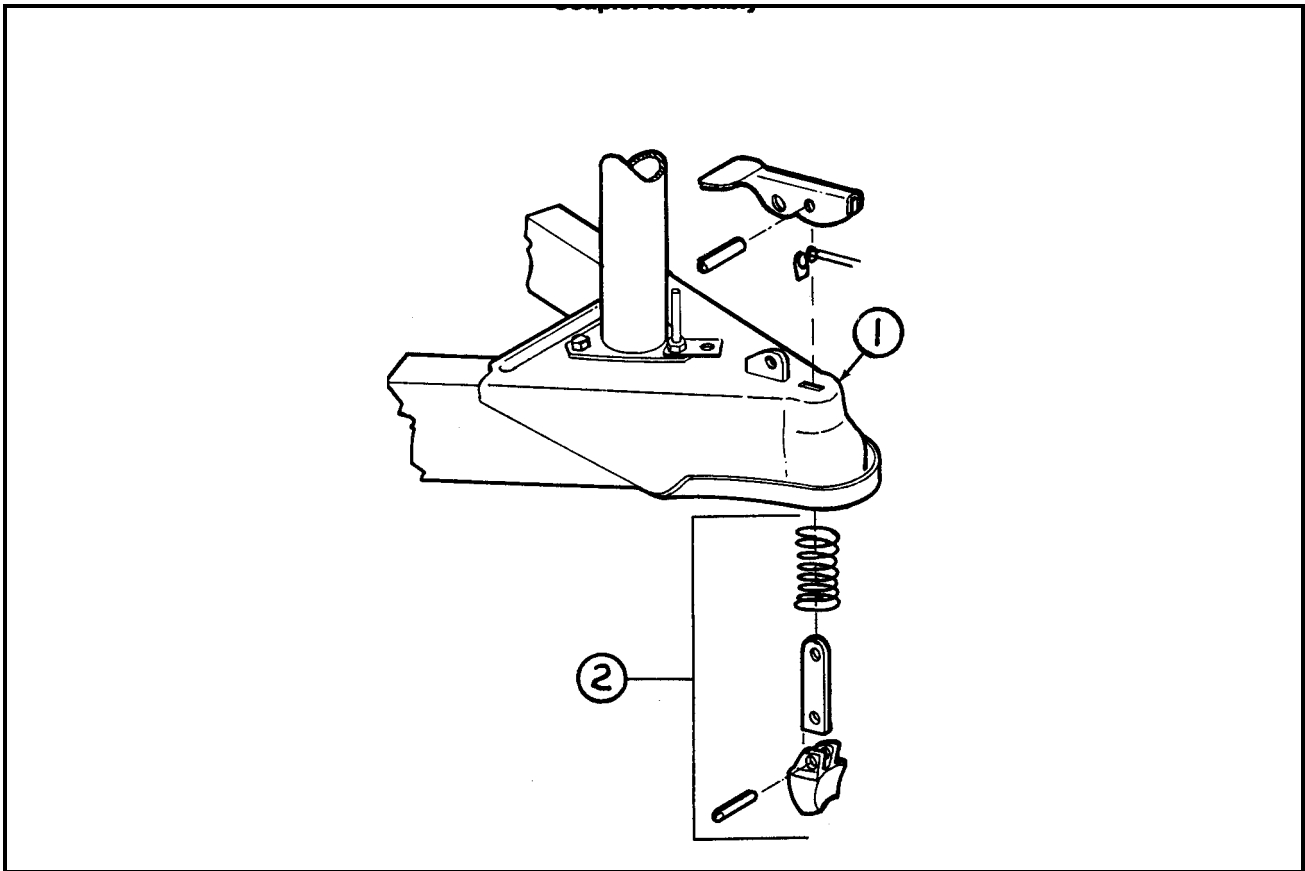

- 1) 680343 Coupler assembly, 2 5/16"
- 2) 680345 Repair kit, 2 5/16" coupler

(continued)

2001 SAFARI

CHASSIS

12" BRAKES

3160121	Brake drum, 12", 6 lug
450659	Inner bearing, #25580
680364	Inner race, #25520
450658	Outer bearing, #LM67048
680365	Outer race, #LM67010
680370-100	Grease seal
3160347	Brake assembly, RH, 12" Dexter
3160348	Brake assembly, LH, 12" Dexter

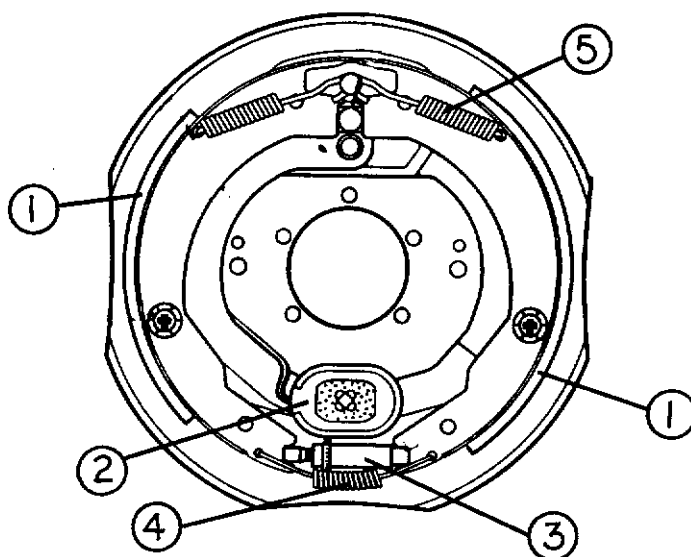

1) 3160348-62	Shoe and lining kit (includes hold down spring and pin)
2) 3160348-65	Magnet kit
3) 3160348-63	Adjuster assembly
4) 3160348-64	Adjusting screw spring
5) 3160348-61	Retractor spring

2001 SAFARI

NOTES:

SECTION II

D through E

DECALS/EXTERIOR TRIM II-1

DOORS/WINDOWS/AWNING

Doors II-2

Windows II-3

Awning II-3

DRAPES/BLINDS/VALANCES..... II-4

ELECTRICAL

110 volt II-5

12 volt..... II-6

ENTERTAINMENT

Radio/antenna II-8

2001 SAFARI

DECALS/EXTERIOR TRIM

386050-01	Decal stripe, side, Safari/Bambi
385964-02	Decal, "AIRSTREAM" 32", front and rear
386054	Decal, logo, "SAFARI", sides
386063-02	Medallion, oval, blue, "AIRSTREAM", 8in.
386067-02	Medallion, 70th anniversary, 4 3/8in.
386068	Medallion, screen door, 3", black
114460	Extrusion, rub rail, 16'
201763-01	Insert, rub rail, chrome, 1"
114466-01	Close out, casting, rub rail, angled RH
114466-02	Close out, casting, rub rail, angled LH
114465-01	Close out, casting, rub rail RH
114465-02	Close out, casting, rub rail LH
114328	Extrusion, beltline
201912	Molding, chrome, beltline insert

2001 SAFARI

DOORS/WINDOWS/AWNING

(Hardware such as hinges, locks and latches are located in the **hardware** section of this book.)

DOORS

110067-01	Main door assembly
114652	Jamb, main door, preformed
114653	Frame, main door, preformed
114448-02	Skin, exterior, upper main door
114449-02	Skin, exterior, lower main door
114475	Skin, inner, vinyl clad
114363	Drip cap, main door
365232	Seal, main door
381704	Seal, upper main door (goes over 365232)
114654	Screen door assembly
114561	Panel, slider, screen door
114561-01	Panel, slider, screen door, Revised for deadbolt
203000-01	Close out, plastic screen door
203287-02	Close out, plastic, screen door w/ dead bolt
380079	Screen, gray
200518	Spline, gray, screen insert
365013	Gasket, screen door, foam tape
922243	Door, refrigerator access
104417	Jamb, refrigerator access door
104439	Louvered panel, refrigerator access door
203225	Trim, flexible
100679-01	Side access door assembly
365035	Seal, side access door
921159-01	Trunk door assembly, rear, 27 twin
365035	Seal, access door
114675	Jamb, rear trunk door

(continued)

2001 SAFARI

DOORS/WINDOWS/AWNINGS

(Hardware such as hinges, locks and latches are located in the **hardware** section of this book.)

WINDOWS

371362-01	Window, 17.75" x 21.25"
371362-02	Window, 19.25" x 22.75"
371362-07	Window, 19.25" x 29.75"
371362-08	Window, 31.25" x 29.75"
371362-12	Window, 49.63" x 24.19", egress rear
371362-09	Window, 49.63" x 24.19", split egress, 23&25 "C"
371362-05	Window, 49.63 "x 24.19", front
110460-01	Trim ring, window, 17.75" X 21.25"
110460-02	Trim ring, window, 19.25' x 22.75"
110460-06	Trim ring, window, 19.25" x 29.75"
110460-07	Trim ring, window, 31.25" x 29.75"
110460-05	Trim ring, window, 49.63" x 24.19"
110521-01	Trim ring, window, rear egress, 23 "C"
110521	Trim ring, window, rear egress, 25 "C"

AWNINGS

110102-01	Rock guard
685351	Rubber frame, black
683960	Arm support
683959	Arm support bracket
685354	Front window key
702993-02	Awning, patio, 14' 4½", 23ft.
702993-01	Awning, patio, 16' 4½", 25ft.
702993-03	Awning, patio, 18' 4½", 27ft.
702993	Hardware package, Zip Dee

2001 SAFARI

DRAPES/BLINDS/VALANCES

110552	Drapery set, 27ft.
702868-01	Drape, galley, CS, aft 2 plt, 12" x 20.5"
702868-02	Drape, galley, CS, fwd 2 plt, 12 x 20.5"
702868-03	Drape, lounge, CS, aft, 6 plt, 25" x 33.5"
702868-04	Drape, lounge, CS, fwd, 6 plt, 25" x 33.5"
702868-05	Drape, lounge, RS, fwd 9 plt, 35" x 33.5"
702868-06	Drape, lounge, RS, aft, 9 plt, 35" x 33.5"
702868-07	Drape, bedroom, CS, aft, 6plt, 25" x 33.5"
702868-08	Drape, bedroom, CS, fwd 6plt, 25" x 33.5"
702868-09	Drape, bedroom, RS, aft, 6 plt, 25" x 33.5"
702868-10	Drape, bedroom, RS, fwd 6 plt, 25" x 33.5"
702868-11	Drape, bedroom RS and lounge CS 16 plt 60" x 25.5"
702868-12	Drape, bedroom CS and lounge RS, 16plt 60" x 25.5"

2001 SAFARI

DRAPES/BLINDS/VALANCES

110485	Drapery set, 25ft.
702868-01	Drape, galley, CS, aft, 2 plt, 12" x 20.5in.
702868-02	Drape, galley, CS, fwd, 2 plt, 12" x 20.5in.
702868-03	Drape, lounge, CS, aft, 6 plt, 25" x 33.5in.
702868-04	Drape, lounge, CS, fwd 6 plt, 25" x 33.5in.
702868-05	Drape, lounge, RS, fwd 9 plt, 35" x 33.5in.
702868-06	Drape, lounge, RS, aft 9plt, 35" x 33.5in.
702868-07	Drape, bedroom, CS, aft 6 plt, 25" x 33.5in.
702868-08	Drape, bedroom, CS, fwd 6plt 25" x 33.5in.
702868-09	Drape, bedroom, RS, aft 6plt, 25" x 33.5in.
702868-10	Drape, bedroom, RS, fwd 6plt, 25" x 33.5in.
702868-11	Drape, bedroom RS and lounge CS, 16 plt, 60" x 25.5in.
702868-12	Drape, bedroom CS and lounge RS, 16 plt, 60" x 25.5in

2001 SAFARI

DRAPES/BLINDS/VALANCES

110505	Drapery set, 25f, "C"
702868-01	Drape, galley, CS, aft 2 plt 12" x 20.5in.
702868-02	Drape, galley, CS, fwd 2 plt 12" x 20.5in.
702868-03	Drape, lounge, CS, aft, 6 plt, 25" x 33.5in.
702868-04	Drape, lounge, CS, fwd, 6 plt, 25" x 33.5in.
702868-05	Drape, lounge, RS, fwd 9 plt, 35" x 33.5in.
702868-07	Drape, bedroom, CS , aft 6 plt, 25" x 33.5in.
702868-08	Drape, bedroom, CS , fwd 6 plt, 25" x 33.5in.
702868-09	Drape, bedroom, RS , aft 6 plt, 25" x 33.5in.
702868-10	Drape, bedroom, RS , fwd 6 plt, 25" x 33.5in.
702868-11	Drape, bedroom RS and lounge CS, 16 plt 60" x 25.5in.
702868-12	Drape, bedroom CS and lounge RS 16 plt, 60" x 25.5in.
702868-13	Drape, lounge, RS, aft, 25" x 33.5in.
702868-14	Drape, dinette, RS , fwd 10 plt, 37" x 28.5in.
702868-15	Drape, dinette, RS , aft 10 plt, 37" x 28.5in.
702868-16	Drape, bedroom, CS 16 plt, 72" x 25.5in,

2001 SAFARI

DRAPES/BLINDS/VALANCES

110525	Drapery set, 23ft.
702868-01	Drape, galley, CS, aft 2 plt, 12" x 20.5in.
702868-02	Drape, galley, CS, fwd 2 plt, 12" x 20.5in.
702868-03	Drape, lounge, CS, aft 6 plt, 25" x 33.5in.
702868-04	Drape, lounge, CS, fwd 6 plt, 25" x 33.5in.
702868-05	Drape, lounge, RS, fwd 9 plt, 35" x 33.5in.
702868-06	Drape, lounge, RS, aft 9 plt, 35" x 33.5in.
702868-07	Drape, bedroom, CS, aft 6 plt, 25" x 33.5in.
702868-08	Drape, bedroom, CS, fwd 6 plt, 25" x 33.5in.
702868-11	Drape, bedroom RS and lounge CS, 16 plt, 60" x 25.5in.
702868-12	Drape, bedroom CS and lounge RS, 16 plt, 60" x 25.5in.
702868-16	Drape, bedroom, CS 16 plt, 72" x 25.5in.

2001 SAFARI

DRAPES/BLINDS/VALANCES

702355-01 Shade, roller type, 20 1/8 x 36" galley

964104-25S Valance, lounge, RS 64"

964105-25S Valance, lounge, CS 35"

964106-25S Valance, rear twin 43" (both sides)



101220
Bracket, curtain
stand off



101217
Track, curtain

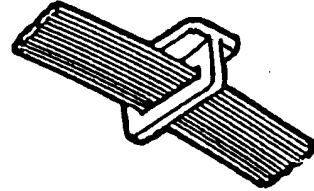

700044
Glides, w/elastic
"T" type



114021
Bracket, curtain
stand off



101225
Bracket, curtain
stand off

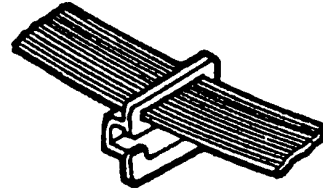

700045
Glides, w/elastic
"G" type

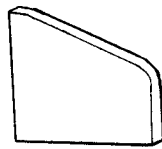

200785
End, curtain track, LH

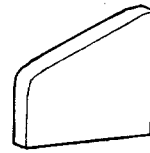

200784
End, curtain track, RH

2001 SAFARI

ELECTRICAL

110 VOLT

510634	Power cord, 36ft.
511041	Breaker box, Westinghouse
510564-05	Breaker 30-20, Bryant
510564-04	Breaker 20-20, Bryant
510564-20	Breaker, 20 GFI
510564-07	Breaker 15 GFI, Bryant
500563-01	Receptacle, 15 amp, white
511287	Receptacle, 15 amp, single
510676-01	Outlet, exterior, gray
511023	Circuit tester (loose item)
511426	Converter, 55 amp

2001 SAFARI

ELECTRICAL

12 VOLT

511132	Battery, deep cycle, lead acid
511386	Battery box
340023	Latch, Corbin, battery box
453603	Strap, battery box
500886	7-Way cable w/plug
0300027	Break away switch, Bargman
511426	Converter, 55 amp
510626	Switch, master disconnect
510627	Face plate, disconnect switch
511337	Fuse block, 12 volt, 6 position-ATC type
511248	Light, 12 volt, incandescent, single, interior
511249	Light, 12 volt, incandescent, double, interior
510781	Detector, smoke
511309	Detector, LPG
511341-02	Monitor panel, wall mount
502056	Mounting plate, 12 volt switch
511327	Switch body w/rocker, single, white
510868-03	Switch panel, 4 gang, white, by door
511567-02	Switch body w/Rocker switches two gang white
511566-02	Cover, switch, Printed, Two Gang, White
510807	Outlet, 12 volt
511121	Mounting plate, 12 volt receptacle

(continued)

2001 SAFARI

ELECTRICAL

12 VOLT

500996	Jack, TV/phone, gray
510654-01	TV jack/12 volt w/splitter, white
510624-01	Modular phone quick jack, white
104619	Mounting plate, exterior telephone/TV jack

EXTERIOR LIGHTS/REFLECTORS

500092	Patio light, round, Signal Stat
510160	Bulb, patio light #1156
510732	Utility light (by main door)
510651	Light, front access compartment
500500	Tail light assembly
510161	Can, #1156 bulb and socket
510160	Can, #1157 bulb and socket
510162	Tail light lens
510163	Back-up light lens
380226	Gasket, tail light lens
201462	Pocket , plastic, taillight
109172	Bezel, chrome, tail light
510111	Clearance light, red, Signal Stat
510112	Clearance light, amber, Signal Stat
500095	Reflector, red, rectangular
500096	Reflector, amber, rectangular
510446	Reflector, red, stick-on w/chrome edge
500053	License plate light w/plate mounting bracket
511294	Light, license plate
510658	Switch w/weather proof boot

2001 SAFARI ENTERTAINMENT

511498	Radio, AM/FM/Cassette, Sony XR-1100MR04
511048	Speaker, 40 Watt, Coustic HS-402
511499	CD changer, 10 unit, Sony CDX-434RF(opt.)
510610	Antenna, radio, side mount
510788-01	TV antenna, Winegard #RV-7004
510788-03	Amplifier, TV antenna
510612	Coax, 75 ohm, standard
510613	Coax, 75-ohm w/three conductors
510623	Connector, coax, male to male
114396	Trough, TV antenna

2001 SAFARI

SECTION III

F through H

FASTENERS (common fasteners available locally are not listed)

Rivets..... III-1

FLOOR COVERING

Carpet III-3

Mats..... III-3

FURNITURE

Interior doors III-4

Mirrors..... III-5

Drawer III-5

Rear bedroom..... III-6

Bath III-7

Galley..... III-10

Lounge III-14

HARDWARE

Exterior locks/hinges..... III-17

Interior drawer slides/hinges latches III-21

Bath accessories III-24

Awing hardware III-26

2001 SAFARI

*FASTENERS



325043
Rivet, buck type
dia. 1/8"
length 1/4"
(hard)



325000-01
Rivet, buck type
dia. 1/8"
length 1/4"
anodized clear



325000-03
Rivet, buck type
dia. 1/8"
length 1/4"
anodized white



325001-01
Rivet, buck type
dia. 1/8"
length 5/16"
anodized clear



325002-01
Rivet, buck type
dia. 1/8"
length 3/8"
anodized clear



325004-01
Rivet, buck type
dia. 1/8"
length 1/2"
anodized clear

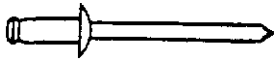

330127-03
dia. 1/8"
grip range .063-.125
aluminum body
aluminum mandrel



300101
1/8" I.D.
washer, aluminum

*Common bolts and screws readily available at local hardware outlets have not been listed.

2001 SAFARI

*FASTENERS

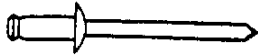

330126-02
rivet, pop
dia. 1/8 "
grip range .126-.187
stainless steel
stainless steel mandrel

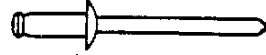

330126-03
rivet, pop
dia. 1/8 "
grip range .126-.250
body stainless steel body
stainless steel mandrel

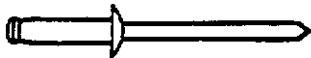

330127-050
rivet, pop
dia. 1/8 "
grip range .251-.312
aluminum body
aluminum mandrel

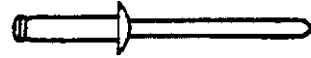

330128-05
rivet, pop
dia. 1/8 "
grip range .251-.312
aluminum body, white
aluminum mandrel



330127-080
rivet, pop
dia. 1/8 "
grip range .325-.565
aluminum body
aluminum mandrel

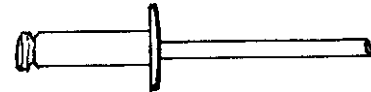

330038
rivet, pop
dia. .150 (#20 bit)
grip range .126-.250
aluminum body
aluminum mandrel
(used-screen door hinge)



325103
dia. 1/4 "
grip range .080-.325
SS body, steel mandrel

*Common bolts and screws not listed.

2001 SAFARI

FLOOR COVERING

702794-05	Carpet, Spectrum, Saturn Blue
701538	Carpet, Velour-compartment liner
700173	Pad, carpet, 3/8" thick
381346-01	Floor mats
703037	Flooring, laminate, bath, Capisto Sand, 15.5" x 15.5"
801291-03	Trim, laminate flooring, Capisto Sand

2001 SAFARI
FURNITURE
WARDROBE/CABINET DOORS

width x height(inches)

964385-25	Door	8.75 x 38.0"
964385-14	Door	8.75 x 62.0"
964385-17	Door	9.13 x 24.0"
964385-26	Door	12.0x 38.0"
964385-27	Door	13.19 x 31.25"
964385-18	Door	13.25 x 62.0"
964385-12	Door	13.63 x 38.0"
964385-10	Door	14.00 x 21.0"
964385-02	Door	14.25 x 31.25"
964385-21	Door	15.63 x 11.88"
964385-20	Door	15.75 x 13.75"
964385-23	Door	17.38 x 22.0"
964385-06	Door	17.75 x 13.75"
964385-01	Door	18.63 x 31.25"
964385-09	Door	18.75 x 8.5"
964385-22	Door	21.00 x 62.0"
964385-15	Door	22.25 x 62.0"
964385-04	Door	23.00 x 8.00"
964385-19	Door	24.88 x 10.5"
964385-24	Door	25.13 x 15.25"
964385-13	Door	25.13 x 17.50"
964385-07	Door	32.50 x 13.75
964385-08	Door	45.00 x 13.75
964385-16	Door, breaker box cover	7.5 x 13.75"

2001 SAFARI
FURNITURE
ROOF LOCKER DOORS

964386-01	Door, roof locker, front and rear-RH&LH, 31.25
964386-02	Face panel, locker end filler, spec. RH or LH
964386-06	Door, roof locker, 32.5"
964386-04	Face panel, 6.19", rear locker, "C" model
964386-03	Door, galley roof locker, 28.38"
964386-05	Door, galley roof locker, 35.5"

MISCELLANEOUS DOORS

702937-03	Shower door, roll away, 36" x 62"
961413-16	Door slider assembly, 20.5" x 74"
964539	Bath door assembly, 25.5" x 72", "C" model
986265	Sliding door assembly, 25ft., "A & B" model
372203-04	Mirror, safety glass, medicine cabinet, 36" x 14"
372203-05	Mirror, safety glass, medicine cabinet, 19" x 14"
372203-24	Mirror, safety glass, 9.5" x 20.0"
702681-04	Door, foldette, 56" x 73"
702681-03	Door, foldette, 46" x 73"
381563-01	Track, formed, foldette door
701342-01	Strap, foldette door, retainer

DRAWERS/DRAWER BOX

201016	Drawer, plastic, 16" x 22"	
201051	Drawer, plastic, 10" x 22"	
964906-03	Drawer box	2.75" x 14.0" x 11.50"
964906-06	Drawer box	2.75" x 12.0" x 18.00"
964910-09	Drawer box	5.00" x 18.0" x 17.50"

2001 SAFARI

FURNITURE

REAR BEDROOM, TWIN-25 & 27FT.

964113	Night stand assembly
964337	Top, twin nightstand
964173	Twin bed assembly, CS
964114-01	Twin bed assembly, RS
964115-01	Hanging wardrobe assembly, RS
964155	Hanging linen closet, CS

REAR BEDROOM, DOUBLE-25 & 27FT.

964188	Double bed assembly, "B" model
964115-01	Hanging wardrobe, RS
964184	Nightstand
963336	Top, rear nightstand, rear double
381241	TV shelf

REAR BEDROOM, CORNER DOUBLE-23 & 25S

108433	Header, foldette door
200003	End cap mounting, brown
381563-01	Track, formed, foldette door
964252	Bed assembly, corner double, Safari
964397	Wardrobe assembly, RS 23ft.
964250	Wardrobe assembly, RS 25ft.
381241	TV shelf, Oak w/mirror

2001 SAFARI

FURNITURE

BATHROOM, CORNER DOUBLE-23 & 25S

See hardware section for fixtures.

If connected to water, see plumbing.

203114	Shower, two piece fiberglass
203138-03	Plastic wall extrusion, beige
964325	Toilet stand assembly
964249	Lavatory cabinet
964315	Lavatory top
964319	Medicine cabinet, lower
964318	Medicine cabinet, upper
964312	Header, bath door
801209-004	Jamb, bath door
104606	Close-out, vent pipe
964415	Close out, paper holder
703106	Border trim, self-adhesive, bathroom

2001 SAFARI

FURNITURE

BATHROOM 25FT. A & B MODELS

See hardware section for fixtures.

If connected to water, see plumbing.

201980	Shower stall, two-piece, fiberglass
964226	Shower stand assembly
964132	Toilet stand assembly
801195	Corner, trim-1" radius
964618	Jamb, shower door
964130-01	Lavatory cabinet assembly
964340	Lavatory top
200963-01	Track, sliding door, vanity, upper
200963-02	Track, sliding door, vanity, lower
104606	Close out, alabaster, vent pipe
114040-01	Close out, toilet line
381611	Cosmetic cabinet 36" x 9"
964129	Medicine cabinet
702791	Border, adhesive back, above lavy

2001 SAFARI

FURNITURE

BATHROOM, 27FT. A & B MODELS
(see hardware section for fixtures-if connected
to water, see plumbing)

203046-03 964993	Shower stall, angled, two-piece Close out, lavy/shower
964473 964491	Lavatory cabinet assembly Lavatory top assembly
200963-01 200963-02	Track, sliding door, vanity, upper Track, sliding door, vanity, lower
381611 964129	Cosmetic cabinet 36 x 9" Medicine cabinet assembly
702791	Border trim, self adhesive, above bath cabinet
104606 114040-01 800727-01	Close out, vent pipe, alabaster Close out, toilet line Close out, foldette door, Oak
964466	Wardrobe assembly CS-27ft.

2001 SAFARI

FURNITURE

GALLEY AREA, 23FT.

964523-01	Galley assembly
964524-01	Galley top assembly
964335	Galley flip-up shelf
963990	Magazine rack
964980-01	Sink cover
381615	Tray, plastic, 11"
964151	Galley roof locker assembly
964251	Refrigerator cabinet assembly
964532	Spice rack
372203-05	Mirror, safety glass 19" x 14"
964396	Pantry cabinet assembly
381400	Drawer slide, pantry, 14", pr.
964162	Pantry assembly

2001 SAFARI

FURNITURE

GALLEY AREA, 25FT. "C"

964523-01	Galley assembly
964524-01	Galley top assembly
964335	Galley flip-up shelf
963990	Magazine rack
964980-01	Sink cover
964151	Galley roof locker assembly
964251-01	Refrigerator cabinet assembly
964532	Spice rack
372203-05	Mirror, safety glass 19 x 14"
964359	Dinette seat assembly, aft.
964256	Dinette seat assembly, forward
964255	Dinette table assembly, Safari
962177-02	Leg, dinette table, hardwood, 28.5"
964254	Dinette roof locker assembly
964116	Pantry/wardrobe assembly
964162	Pantry assembly
381400	Slides, 14", pantry, pr.

2001 SAFARI

FURNITURE

GALLEY AREA, 25FT. A&B

964523-01	Galley assembly
964524-01	Galley top assembly
964335	Galley flip-up shelf
963990	Magazine rack
964980-01	Sink cover
964151	Galley roof locker assembly
964116	Pantry/wardrobe assembly
964162	Pantry assembly
381400	Slides, 14", pantry, pr.
964149-01	Refrigerator cabinet assembly
964172	Close out, refrigerator cabinet
964532	Spice rack
372203-05	Mirror, safety glass 19 x 14"

2001 SAFARI

GALLEY AREA, 27FT. A&B

964467-01	Galley assembly
964468	Galley top assembly
964335	Galley flip-up shelf
963990	Magazine rack
964980-01	Sink cover
381615	Tray, plastic, 11"
964469	Galley roof locker assembly
964623	Pantry/microwave cabinet assy.
964507	Pantry assembly
381400	Slides, 14", pantry, pr.
964508	Top, pantry cabinet
964472	Refrigerator cabinet assembly
964532	Spice rack
372203-05	Mirror, safety glass 19 x 14"

2001 SAFARI

FURNITURE

LOUNGE AREA, 23 & 25FT. "C" MODEL

964150 Credenza assembly(23ft. only)
964338-01 Top, credenza assembly
960420-07 Table, lift up assembly
960416-06 Leaf, table, lower 24 x 25.88"
960417-07 Leaf, table, upper 24 x 25"
962117-03 Table leg, hardwood, 30.50"
960419-01 Facer board, lift up table

702798-159 *Sofa, jack knife, 74", Kodiak
963400-01 Arm rest support, RS
963400-02 Arm rest support, CS
962563 Close out, lounge, rear
964174 Close out lounge

LOUNGE AREA, 23FT., DINETTE OPT.

965037 Dinette table assembly
965038 Dinette seat assembly, RH
965039 Dinette seat assembly, LH
965044 End table assembly
965045 Top, end table

*Changing the -(dash)number to:

169= Rain Forest
070= Woodland

2001 SAFARI

FURNITURE

LOUNGE AREA, 25FT. A & B MODELS

964150	Credenza assembly
964338-01	Top, credenza assembly
960420-07	Table, lift up assembly
960416-06	Leaf, table, lower 24 x 25.88"
960417-07	Leaf, table, upper 24 x 25"
962117-03	Table leg, hardwood, 30.50"
960419-01	Facer board, lift up table
381306	Slides, pair, lift-up table
702798-159	*Sofa, jack knife, 74", Kodiak
963400-01	Arm rest support, RS
963400-02	Arm rest support, CS
964174	Close out, lounge

*Changing the -(dash)number to:

169= Rain Forest

070= Woodland

2001 SAFARI

FURNITURE

LOUNGE AREA, 27FT. A & B MODELS

964622	Credenza assembly
964509	Top, credenza assembly
960420-02	Table, lift up assembly
960416-02	Leaf, table, lower 24 x 25.88"
960417-02	Leaf, table, upper 24 x 25"
962117-03	Table leg, hardwood, 30.50"
960419-01	Facer board, lift up table

702798-159*	Sofa, jack knife, 74", Kodiak
963400-01	Arm rest support, RS
963400-02	Arm rest support, CS
962563	Close out, lounge, rear
964174	Close out lounge

*Changing the -(dash)number to:

169= Rain Forest
070= Woodland

965342	27 FT Front Dinette credenza assembly
964509	Credenza top

2001 SAFARI

HARDWARE

MAIN DOOR LOCK

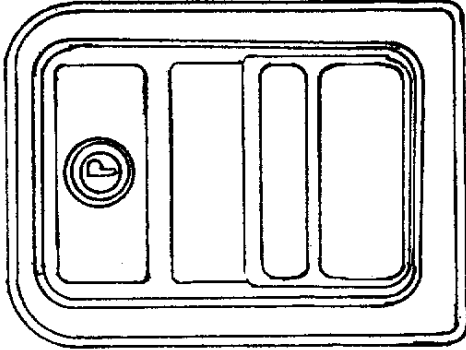

381547-01
Main door lock, outside
Housing

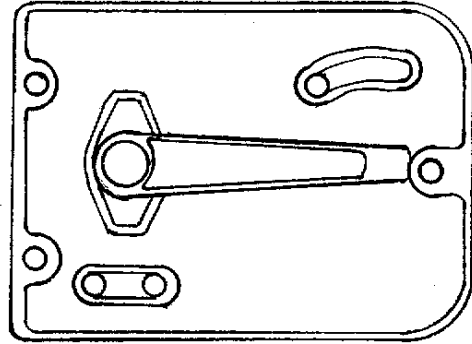

381547-02
Main door lock, inside
plate

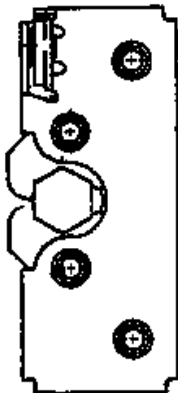

381547-03
Double rotary latch,
main door lock

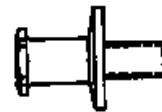

381547-04
Striker bolt w/washer
main door lock

Not shown:

381547-05 Screw package, main door lock
453851 Dead bolt, main door, Tri-mark

2001 SAFARI
HARDWARE
EXTERIOR LATCHES/LOCKS



101171
Grab handle, main door

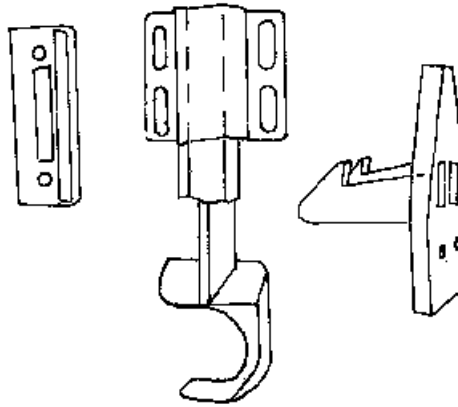

381454
Latch, screen door, Bullet

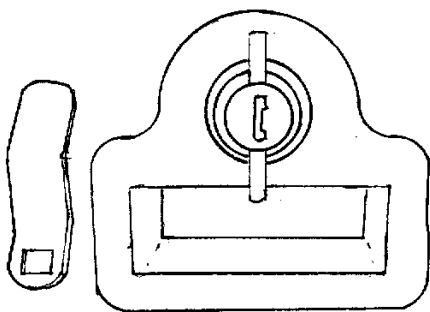

380770-101 Twist lock, chrome
380770-102 Twist lock, black

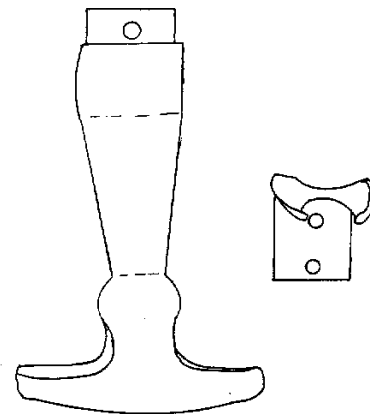

381021 Rubber T handle

2001 SAFARI

HARDWARE

EXTERIOR LATCHES/LOCKS

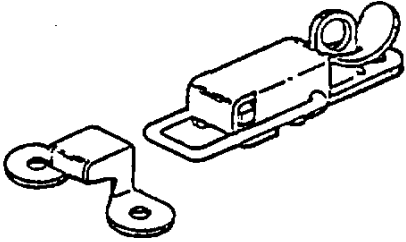

340023 Corbin catch
w/strike, battery box



380067 Lock cam,
bumper lid

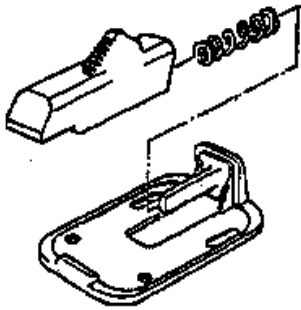

380291 Main door holdback,
(use w/housing #380290)



380290 Latch housing,
(use w/housing #380290)

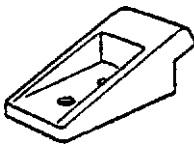

201056 Catch, main door
holdback

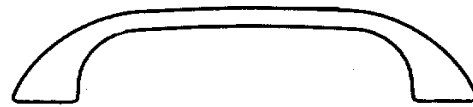

380004 Handle, screen door

2001 SAFARI
 HARDWARE
 EXTERIOR LATCHES/LOCKS

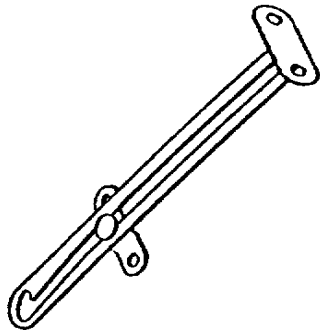

380024 Support arm,
 bumper lid

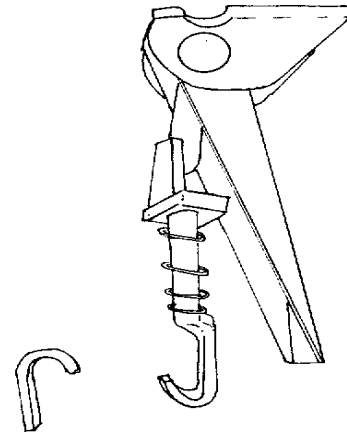

380903 Latch w/strike,
 chrome, gas bottle cover

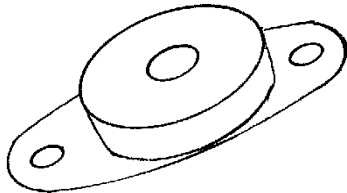

685359
 Rubber receptacle
 1/4 latch, Southco

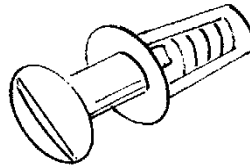

685342
 Stud, 1/4 turn latch
 Southco



685362
 Retaining ring
 1/4 turn stud

EXTERIOR HINGES

381552-03 Hinge assembly, main door, upper

381552-04 Hinge assembly, main door, lower

381531-01 Hinge, screen door, upper

381531-02 Hinge, screen door, lower

380773 Hinge, access door, 1 3/4

380203-01 Piano hinge, 1/8" pin, clear anodized, hose carrier lid

2001 SAFARI HARDWARE

INTERIOR LATCHES/HINGES

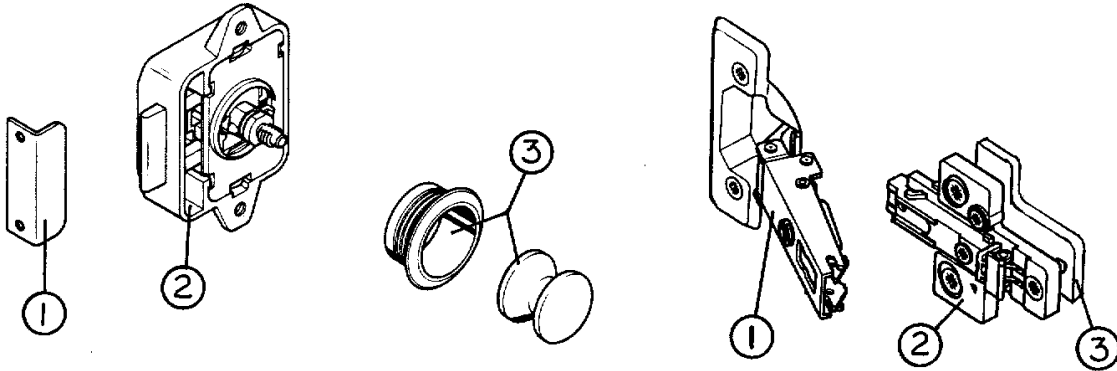

- 1)381608-07 Strike plate, rim lock
- 2)381608-02 Latch, cabinet, rim lock
- 3)381608-03 Push button w/rosette

- 1)381607-01 Hinge, cabinet
- 2)381607-02 Base, metal
- 3)*381607-03 Base, plastic

*Not used in all applications

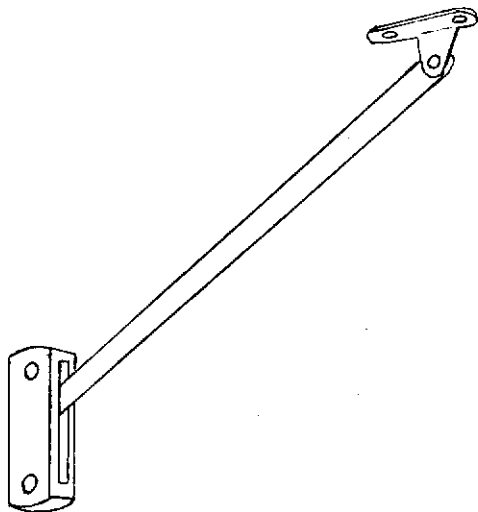

- 381608-04
- 381608-05

- Support arm, roof locker, RH
- Support arm, roof locker, LH

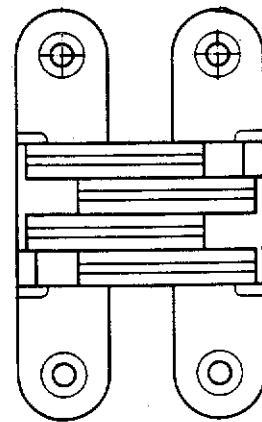

- 380040Soss hinge, lift up table

2001 SAFARI

HARDWARE

INTERIOR LATCHES/HINGES

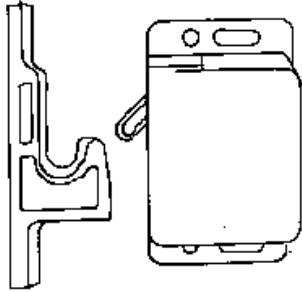

- 381228 Grabber door latch w/catch, 10lb.rating
381228-01 Grabber door latch w/catch, 3lb. rating



- 381228-100 catch only, grabber door latch

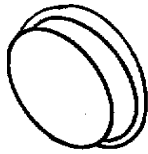

- 201427 Finger pull, light brown



- 381603 Pull, three finger Antique brass



- 360012 Bumper, rubber white, stick-on, cylindrical
360012-01 Bumper, rubber brown, stick-on, cylindrical

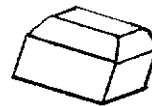

- 360016 Bumper, rubber gray, square 3/8" x 3/8"

2001 SAFARI

HARDWARE

INTERIOR LATCHES/HINGES



381599 Handle drawer/door, brass
381599-01 Handle, drawer, chrome

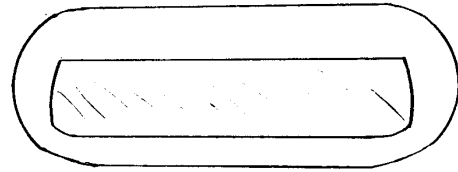

381576 Pull handle, brass



381444 Hatch pull, SST
satin finish

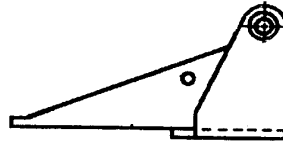

385935-01

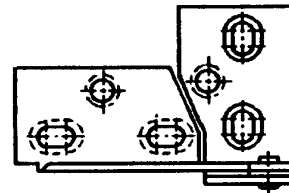

Hinge pivot,
zinc plated



381737 Grab bar, interior,
mounts on interior doorjamb

2001 SAFARI

HARDWARE

DRAWER SLIDES

381526-01	Drawer slide-950-RV, 14"
381526-03	Drawer slide-950-RV, 18"
381414-144	Slide, drawer-Delta, 14.5"
381400	Slide, drawer, 14", 2900-14(pantry)

BATHROOM ACCESSORIES

380034	Toilet paper holder, chrome
381259-01	Towel bar, 18", chrome
380259-03	Brackets, chrome towel bar
380248	Soap dish
381599-01	Drawer pull, chrome

HINGES

380458	Hinge, piano, 3/32 pin, 5/8" leaf, brown
380210	Hinge, 2" metal, bed top
380040	Soss hinge, #204, lift up table
381614	Folding shelf bracket, galley

TABLE HARDWARE

381306	Lift up table slides, one right & one left
201155	Table sliding guide, plastic
380037	Latch, nail & spring, table
380038	Eyelet, lock, brass
380040	Hinge, flush mount, Soss
381147	Support, spring loaded

WARDROBE

380045	Clothes rod
200975-04	Conduit, flexible, black(covers clothes rod)
380046	Bracket, clothes rod

2001 SAFARI

HARDWARE

MISCELLANEOUS

701342-01 Vinyl strap, sliding door hold back
(female snap on both ends)

381100 Sliding door guide

701624 Velcro loop, 5/8" wide

701625 Velcro hook, 5/8" wide

*381385 Dual lock #400-1" strips

*381386 Dual lock #170-1" strips

*These two parts work similar to Velcro but have interlocking knobs rather than hooks and loops.

381747 Hinge, pivot, twin bed top, dinette

2001 SAFARI

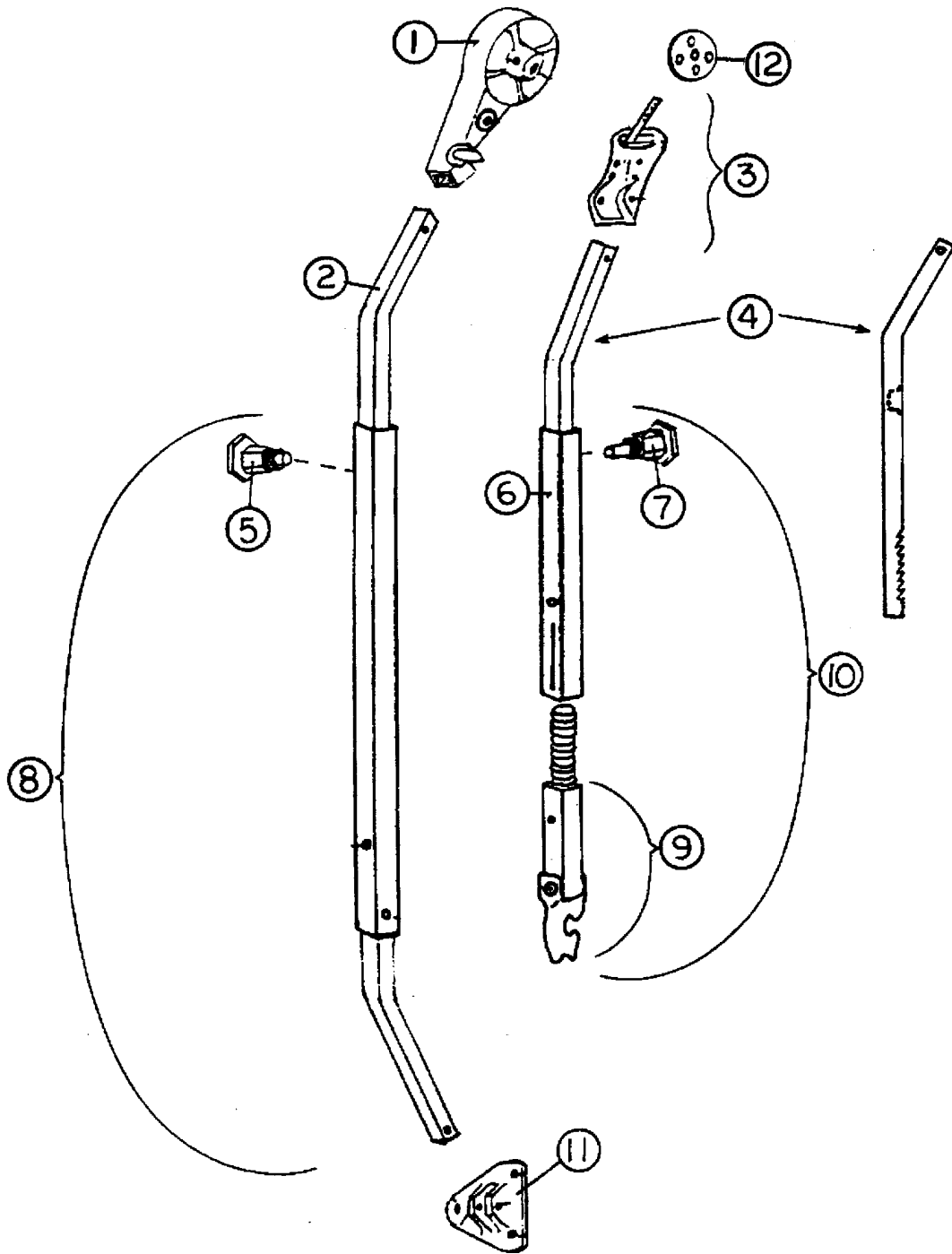

See next page for P/N

2001 SAFARI

HARDWARE

AWNING HARDWARE

- | | |
|----------------|---------------------------------------|
| 1) 702662-100 | Head assembly, front or rear |
| 2) 702662-101 | Main arm bar, front or rear |
| 3) 702622-103 | Clamp assembly, front, curved |
| 3a) 702662-104 | Clamp assembly, rear, curved |
| 4) 702662-105 | Rafter arm bar, satin |
| 5) 702662-106 | Snap stud assembly |
| 6) 702662-107 | Rafter arm tube, satin |
| 7) 74072W | Ratchet stud |
| 8) 74048W | Main arm tube assembly, front or rear |
| 9) 702662-110 | Claw bar assembly |
| 10) 702662-111 | Rafter arm assembly |
| 11) 702662-112 | Base hinge, rib mount |
| 12) 702662-114 | Clamp wheel |

2001 SAFARI

NOTES:

2001 SAFARI

SECTION IV

L through Z

LABELS and TAGS IV-1

PLUMBING

LPG IV-2

Fresh water IV-3

Drain water IV-8

Toilet..... IV-12

SAFETY EQUIPMENT..... IV-14

SEALER/GASKETS/PAINT IV-15

UPHOLSTERY/FOAM/MATTRESS IV-16

VENTS/FANS IV-17

WOOD/LAMINATES/TRIM..... IV-18

2001 SAFARI

LABELS AND TAGS

385193	Label, "12V distribution panel inside"
385048	Label, approval with shield
385269	Label, "DON'T USE AREA FOR STORAGE"
385068	Tag, cooking appliance warning
385067	Label, EXIT
385547	Label, LP gas warning/fill
385517	Label, kill switch warning
385521	Label, emergency egress window
385463	Warning label/cooking appliance
385464	Label, LP gas warning label (odor)
385465	Exit label, English
385560	Label, air conditioner rating
385812	Label, Calif. hazardous substance
385609	Label, smoke detector
385359	Label, microwave or air conditioner
385837	Label, refrigeration ignition
385103	Plate, RVIA
385418-01	Label, Federal registration
385062	Decal, 110-125 voltage AC
385565	Label, holding tank flushing
385972	Label, fuse 12volt

2001 SAFARI

PLUMBING

LPG SYSTEM

601710-01	LP gas bottle, 30lb. steel
601686	Base plate, LP tank mounting
601687	Hold down kit, LP tank
601731	LP regulator, Marshall Brass w/pigtails, mounting Bracket & cover
601731-100	LP pigtails, 15in.
601684-101	Bracket, mounting, LP regulator
601684-102	Cover, Marshall Brass regulator
601412-12	Connector, 1/2" P x 5/8" copper
601685-01	LP hose, 1/2" FPT x 3/8" flare
600468	Union flare, 5/8" x 5/8"
600238	Union flare, 3/8" x 3/8"
600004	Copper tubing, 5/8"
600008	Copper tubing, 3/8"
600436	Flare nut, forged, 5"/8
600435	Flare nut, forged, 3/8"
600000	Tee, brass, 5/8" x 5/8" x 3/8"
600003	Tee, brass, 5/8" x 3/8" x 3/8"
104264	Gas bottle cover w/o decal
380903	Latch and strike
200841	Lid, plastic, bottle cover
380773	Hinge, access door

2001 SAFARI

PLUMBING FRESH WATER

601194	Water fill w/lock, gray
601643	Tank, fresh water
601642	Pan, tank support
601243	Drain cock, fresh water tank
600836	Elbow, 1/2" barb x 3/8" MPT
601237	Plastic elbow, 90 degree, 1.25" MPT x 1.25" barb
601239	Tubing, 1.375" I.D., flexible, water fill hose
601061-03	Water pump, Shurflo
601668	Filter, pre water pump
601588	Drain cock, brass, water line drain

CITY WATER

600362	Connector, 1/2" FPT x water hose, swivel
600336	Plug with chain
601690	Nipple, 1/2" MPT x 2.50"
601689	Drop ell, 90 degree, 1/2" FPT
600309	Regulator, Watts, 1/2" FPT

FITTINGS

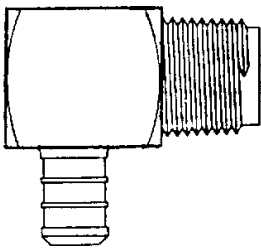

601698-04
Elbow, 1/2" barb
x 1/2" MPT

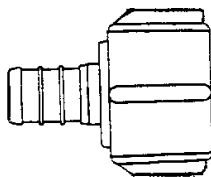

601698-03
Coupler, 1/2" barb
x 1/2" FPT

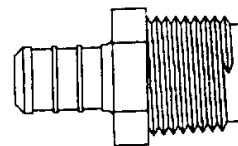

601698-02
Coupler, 1/2" barb
x 1/2" MPT

(continued)

2001 SAFARI
PLUMBING
FRESH WATER-FITTINGS

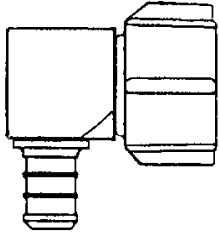

601698-05
Elbow 1/2" barb x
1/2" FPT

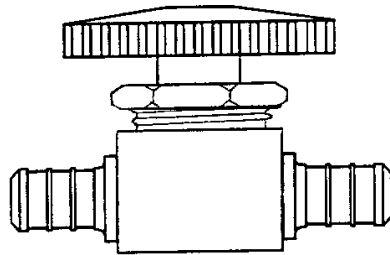

601698-07
Shut-off, 1/2" barb x
1/2" barb

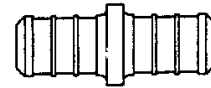

601698-08
Coupler
1/2" x 1/2" barb

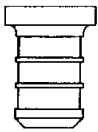

601698-09
Plug, 1/2" barb

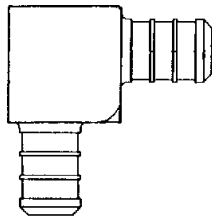

601698-10
Elbow 1/2" barb x
1/2" barb

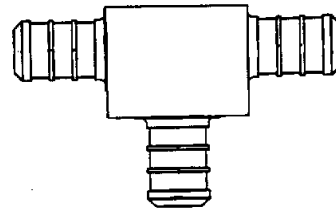

601698-11
Tee, 1/2" x 1/2" x
1/2" barb



601698-15
Crimp ring, 1/2
E-Pex, 1/2" (black)

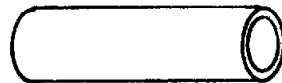

601698-01
E-Pex tube, 1/2"

2001 SAFARI
PLUMBING
FRESH WATER FAUCETS

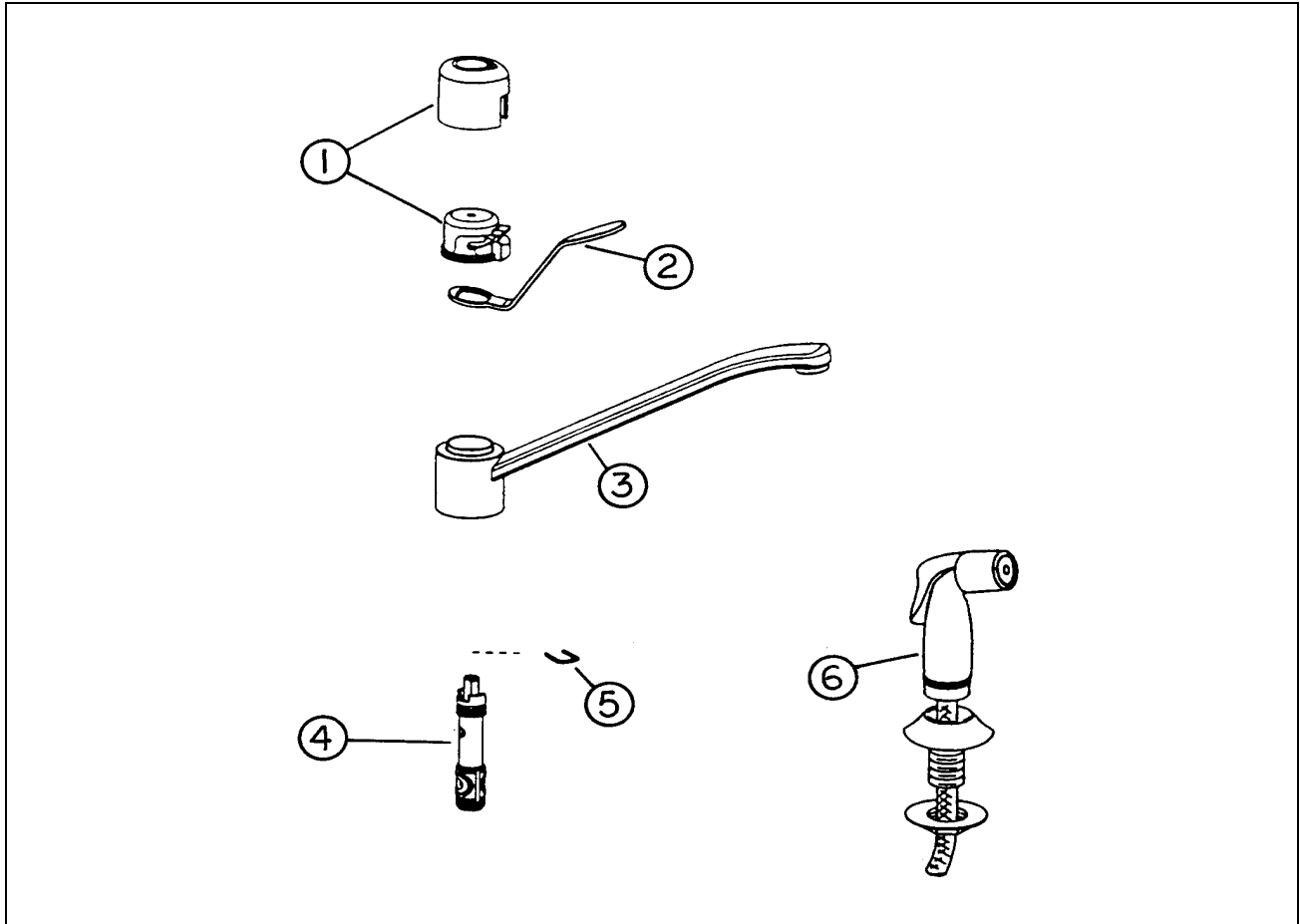

601746 Galley faucet, Moen Manor

- | | |
|---------------|------------------------------------|
| 1) 013098 | Galley lever handle set, Moen |
| 2) 601746-100 | Lever handle, Moen |
| 3) 601746-101 | Spout assembly, 9" Moen |
| 4) 601579-106 | Cartridge, Moen #1225 |
| 5) 601579-105 | Horseshoe clip, cartridge retainer |
| 6) 601418-100 | Spray head and hose, Moen |

2001 SAFARI
PLUMBING
FRESH WATER FAUCETS

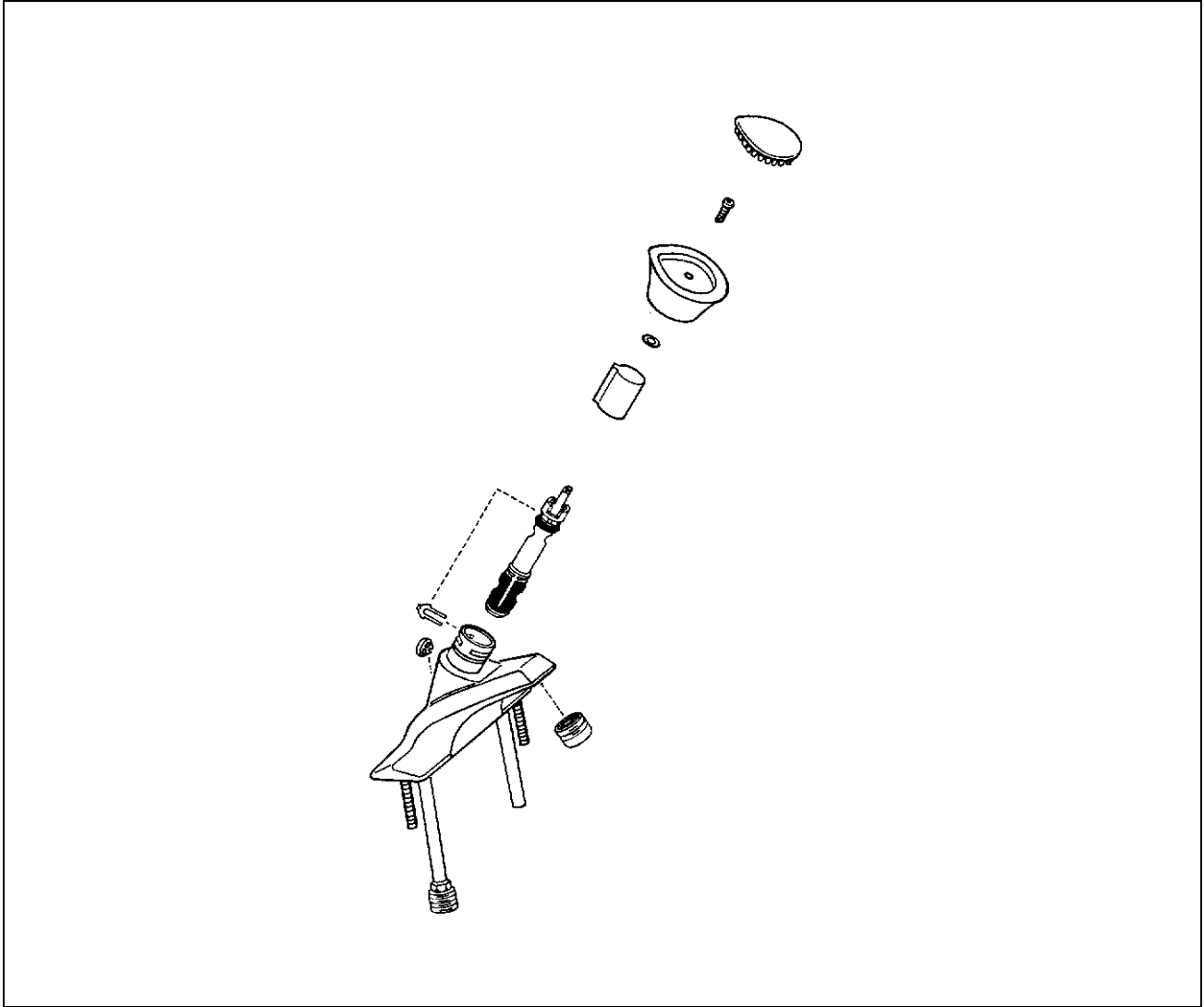

601419-01 Faucet, lavatory, Moen, chrome

- 1) 001245 Knob
- 2) 601579-105 Cartridge
- 3) 601579-104 Retainer clip

2001 SAFARI

PLUMBING FRESH WATER-FAUCETS

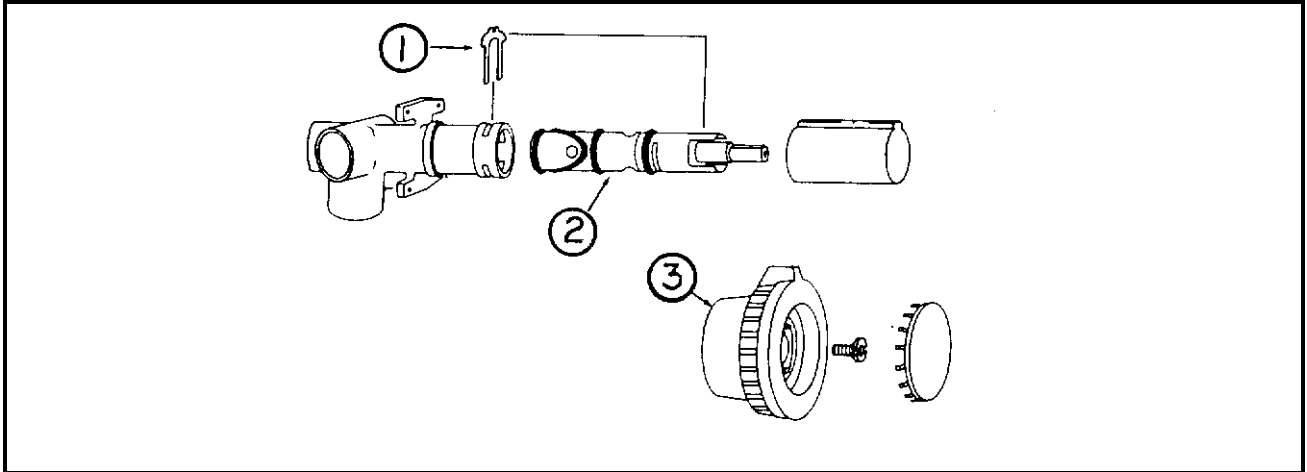

601420-01Faucet, shower

- | | |
|---------------|---------------|
| 1) 000883 | Retainer clip |
| 2) 601420-100 | Cartridge |
| 3) 001041 | Handle |

Not shown:

601358 Shower kit, includes:

Shower hose, shower head,
Vacuum breaker, wall mounts

2001 SAFARI

PLUMBING DRAIN SYSTEM

Auxiliary (Gray) tanks

601622-04 Holding tank, gray-27ft.
601623-08 Holding tank, gray-23 & 25ft."C"
601623-07 Holding tank, gray-25ft."A&B"

Main (Black) Tanks

601623-09 Holding tank, black-27ft.
601458 Holding tank, black-23 & 25ft."C"
601542 Holding tank, black-25ft. "A&B"
203149 Slope pad, holding tanks
601642 Pan, tank support

Sink/showers

203046-03 Shower stall, two-piece, angled-27ft.
201980 Shower stall, two-piece, 25ft. "A&B"
203114 Shower stall, two-piece, 23 & 25ft. "C"
600594 Tub strainer w/rubber stopper

601744-02 Sink, porcelain, galley, Almond
600968 Basket strainer

601498 Sink, lavatory, rectangular, 27ft.
200406-06 Lavatory bowl, oval (includes stopper, basket
and tail) 23 & 25ft.

2001 SAFARI

Drain Tank Valves

601607-11	Valve assembly, 3" spigot x 3" spigot, 25 "C"
601607-13	Valve assembly, 3" hub x 3" spigot, 27ft.
601607-02	Valve assembly, 3" hub x 3" spigot, 25ft.A&B
601470	Dump valve, Valterra, T-68, heel in., 23ft.
600187	Wye, 3" comb & 1/8" bend
600820	3" single socket, 90 degree
600289	Calder coupling, 3" rubber
601607-06	Adapter, 3" hub x 3" bayonet
601607-07	Cap, termination, 3" bayonet
601607-10	Extension rod, 19"
601607-03	Extension rod, 12" threaded
114086	Bracket, dump valve handle

1 1/2" DRAIN FITTINGS

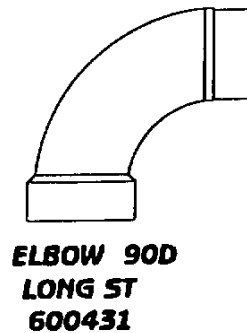
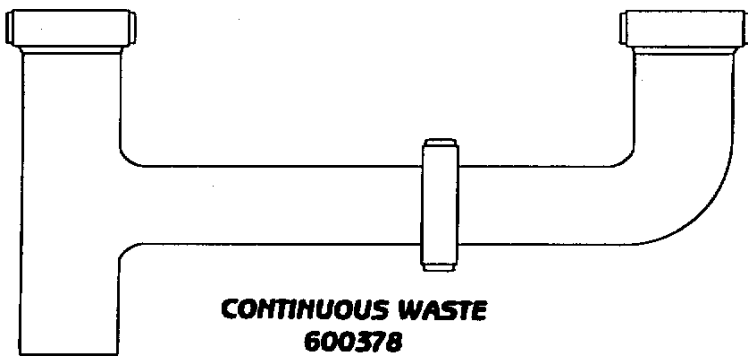

(continued)

2001 SAFARI
PLUMBING
DRAIN FITTINGS, 1.5"

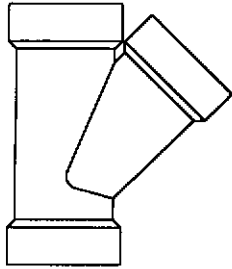

**WYE
#2301
600094**

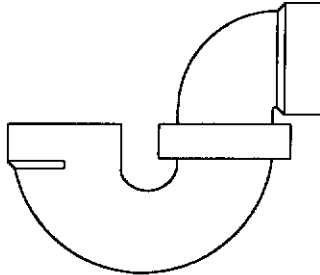

**P-TRAP
1.5" W/O SLIP NUT
600144**

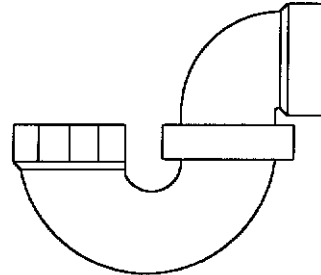

**P-TRAP
1.5" WITH SLIP NUT
600622**

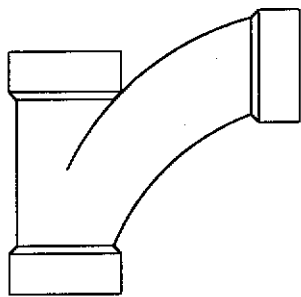

**WYE 1.5"
1/8" BEND
600182**

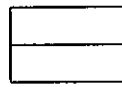

**COUPLING
1.5"
600227**

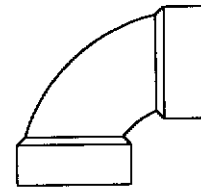

**ELBOW 90D
SHORT SWEEP
601636**

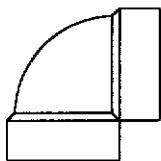

**ELBOW VENT
90D
600033**

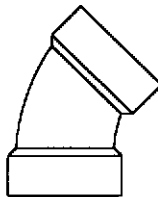

**ELBOW 45D
LONG TURN
600030**

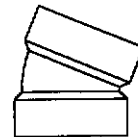

**ELBOW 22.5D
SHORT TURN
600116**

(continued)

2001 SAFARI
PLUMBING
FITTINGS, 1.5" PLASTIC



VENT 1.5"
600538



PLUG 1.5"
600155



CAP 1.5"
601877

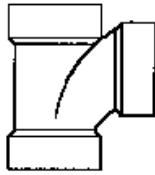

TEE-SANITARY
1.5"
600156

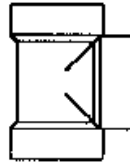

TEE-BI DIRECTIONAL
CLEAN-OUT 1.5"
601318



ELBOW 45D
LONG ST
600027

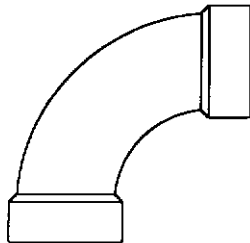

ELBOW 90D
LONG TURN
600035

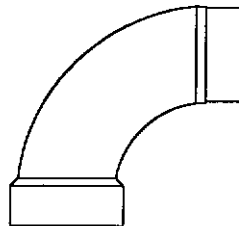

ELBOW 90D
LONG ST
600431

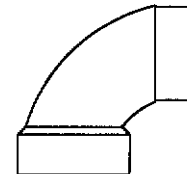

ELBOW 90D
SHORT ST
600662

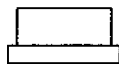

REDUCER 1.5" TO 1.25"
601263



ADAPTER
601676



ADAPTER
W/FEMALE THREADS
600308

2001 SAFARI

PLUMBING

THETFORD, AQUA MAGIC IV, FOOT FLUSH, WHITE

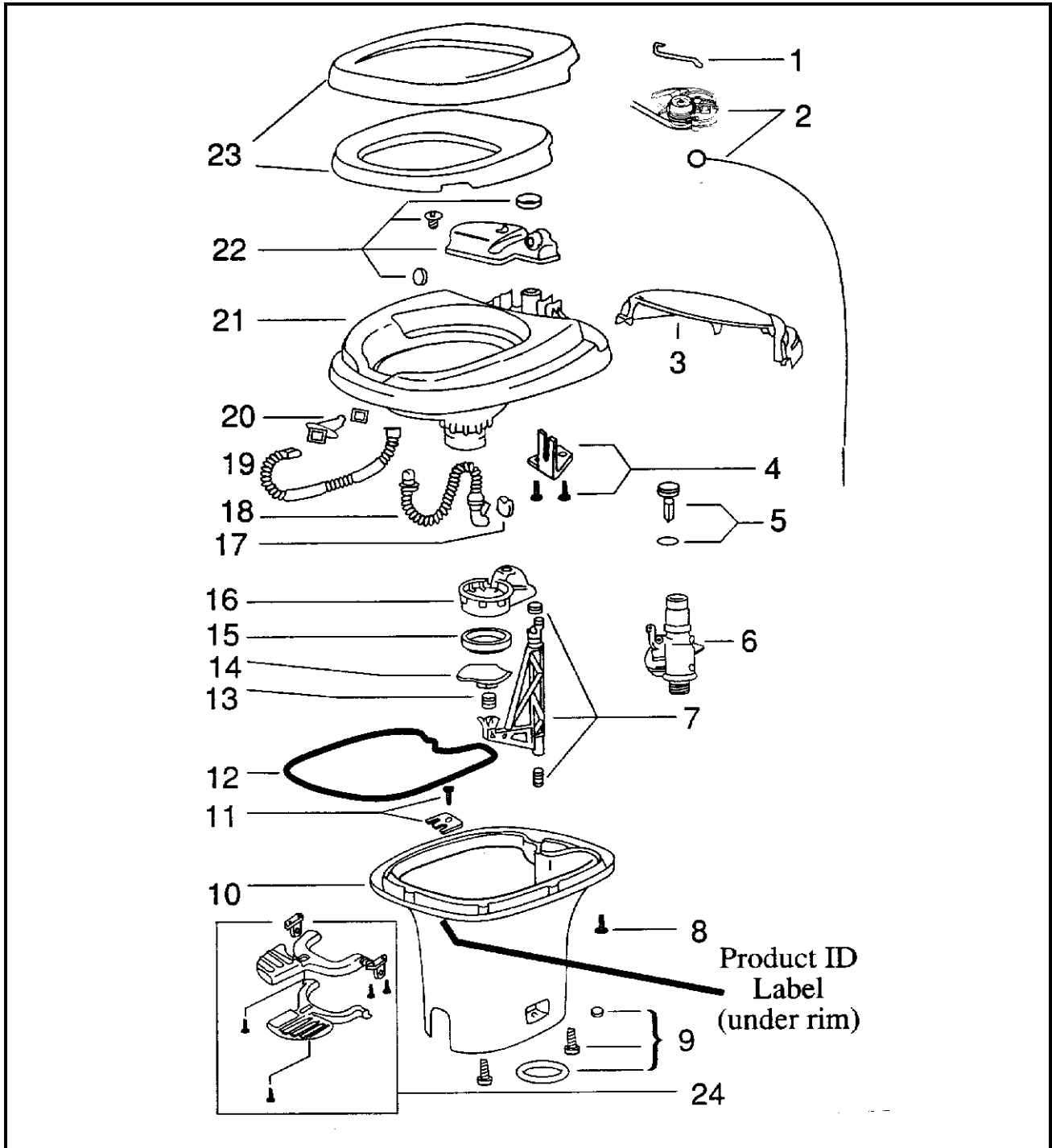

2001 SAFARI

PLUMBING

THETFORD, AQUA MAGIC IV, FOOT FLUSH, WHITE

690387	Toilet complete, Aqua Magic IV, low, 23 & 25ft.
690387-01	Toilet complete, Aqua Magic IV, high, 27ft.
1) 690387-513	Water valve link
2) 690387-571	Wire replacement package
3) 690387-562	Mechanism cover, white
4) 690387-634	Bracket assembly
5) 690387-631	Float assembly
6) 690387-168	Water valve replacement package
7) 690387-632	Actuator assembly
8) 690387-659	Screw base to bowl
9) 690387-524	Closet bolt package
10) 690387-356	Base, white, low
10a) 690387-062	Base, white, high
11) 690387-636	Retainer assembly
12) 690387-387	Sealant, base to bowl
13) 690387-519	Blade spring
14) 690387-262	Blade
15) 690387-481	Blade seal
16) 690387-520	Blade track
17) 690387-512	Flapper
18) 690387-511	Overflow tube
19) 690387-509	Flush tube
20) 690387-637	Nozzle assembly
21) 690387-726	Bowl
22) 690387-630	Reservoir tank assembly
23) 690387-162	Seat and cover assembly
24) 690387-821	Pedal package

2001 SAFARI

SAFETY EQUIPMENT

510781	Smoke detector
511309	LPG detector
600162-01	Fire extinguisher

2001 SAFARI

SEALER/GASKETS/PAINT

SEALER

6000360 Sealant, Butyl #884058
360001 Sealant, #884058
360002 Sealant, Vulkem 11.5 oz. tube
360209 Sealant, seam
360176 Sealant, Almond, kitchen and bath
360180 Sealant, Sikaflex #221
360210 Sealant, Paralastic 4334-014
360283 Sealant, silicone, Corian Bone

GASKETS



365035, Gasket
Access doorjamb



365013-01, Gasket
screen door



365232, Gasket
main door



371593-711, Glazing
Rubber, Creation
Window



371593-713, Seal
plastic, sash
Creation window



371593-712
Foam seal, sash
Creation window

381704 Seal, upper main door (goes over main seal around top of door)
381665 Gasket, D seal, window frame to shell
380226 Gasket, taillight lens
380114 Gasket, vent pip
365016 Tape, foam, double face, 1/2" wide
365001-02 Tape, vinyl foam, double face, 3/4" wide

360213 Paint, aluminum metallic
360151 Paint, gray metallic, Centari
360260 Paint, Pewter
360200-01 Hardener, Centari
360292 Stain, Saratoga Oak

2001 SAFARI

UPHOLSTERY/FOAM/MATTRESS

REAR BEDROOM

701770	Mattress, twin, 34" x 78", 25 & 27ft."A"
702705	Mattress, double, 60" x 75", 25 & 27ft."B"
702704	Mattress, double, 52" x 75", 23&25ft."C"
*702820-159	Bedsread, twin, Kodiak, 25 & 27ft."A"
*702676-159	Bedsread, double, 75", Kodiak 25 & 27ft."B"
*702541-159	Bedsread, corner double, Kodiak 23 & 25ft. "C"
702882-10	Pillow accent, sofa
701611	Pillow, 21" x 31", all models

FRONT LOUNGE

*702798-337	Sofa, jack knife, 74", Cabin Creek, all models
453368-03	Sofa legs, Flex steel
963400-01	Arm rest support, RS
963398-01	Arm rest cushion, RS
963400-02	Arm rest support, CS
963398-02	Arm rest cushion, CS

SIDE DINETTE, 25ft."C"(only)

998070-03	Cover, seat, side dinette
998071-03	Cover, backside dinette
702464-16	Foam, dinette upper back
702464-13	Foam, dinette lower back
702464-14	Foam, dinette aft seat
702464-15	Foam, dinette forward seat

*Changing the -(dash) number to:

169= Rain Forest
070= Woodland
060= Blue Galaxy

2001 SAFARI

VENTS/FANS

100341	Refrigerator, vent collar, large
101394	Cover, refrigerator vent, large
690264-03	Vent pipe cover
380114	Gasket, vent pipe
381606-01	Vent, roof, 14" x 14", non-power, white
381606-02	Trim ring, interior, roof vent, white
381153-01	Vent, Jensen #757, square
511341-01	Range hood, white
511341-05	Range hood, black
511017-11	Vent cover, exterior, range hood, gray
690266-01	Ventilator, power, bath, 25ft.
690264-03	Vent pipe
380114	Gasket, vent pipe
381606-01	Vent, roof, 14" x 14", non-power, white
381606-02	Trim ring, interior, roof vent, white
381153-01	Vent, Jensen#757, square
511341-01	Range hood
511017-11	Vent cover, exterior, range hood, gray
690266-01	Ventilator, power, bath, 25ft.

2001 SAFARI

WOOD/LAMINATES/TRIM

PLYWOOD

800506-04	Plywood, 1/2" x 4' x 8'
800976-01	Plywood, tongue and groove, 19/32'(floor)
800506-05	Plywood, 5/8" x 4' x 8'
800583	Plywood, Birch Baltes(cutting boards) 5/8x5x5
801068-06	Plywood, G2S, 3/4" x 4' x 8'

PANELING

800507-02	Panel, Lauan, 1/4" x 4' x 8', raw/raw
800507-03	Panel, Lauan, 3/8" x 4' x 8', raw/raw
800507-04	Panel, Lauan, 1/2" x 4' x 8', raw/raw
801191-004	Panel, G1S, 1/8" x 4' x 8', Oak vinyl
801261	Panel, G1S, 1/8" x 4' x 8', Antiquity Buff
801181-004	Panel, G1S, 5/32" x 4' x 8', Oak/raw
801182-004	Panel, G2S, 5/32" x 4' x 8', Oak/Oak
801283	Panel, G2S, 1/2" x 4' x 8', Antiquity Buff/Ant. Buff
801179-004	Panel, G1S, 1/2" x 4' x 8', Oak/raw
801274	Panel, G1S, 1/2" x 4' x 8', Antiquity Buff
801180-004	Panel, G2S, 1/2" x 4' x 8', Oak/Oak
801203-004	Panel, G2S, 1/2" x 4' x 8', Oak 6mil
801284-004	Panel, G2S, 1/2" x 4' x 8', Oak/Antiquity Buff
365251-01	Tape, seam, Antiquity Buff, 1 1/8" wide
365251-02	Tape, seam, Antiquity Buff, 8" wide
365251-03	Tape, seam, Antiquity Buff, 12" wide

2001 SAFARI
WOOD/LAMINATES/TRIM

LAMINATES

- 801229 Laminate, Oak, high pressure, .045-.050
801169 Laminate, Beige Pampas, .042 (galley top color)
- 801230 Pre-laminated panel, Oak, 5/8"x4x8, lauan core
801212-01 Pre-laminated panel, Beige Pampas, 5/8"x4x8
- 801184-014 Laminated lumber core, .75 x 1.5 x 8ft.
801184-034 Laminated lumber core, .75 x 2.0 x 8ft.
801184-054 Laminated lumber core, .75 x 2.5 x 8ft.

TRIM

- 800766 Trim, hardwood, .50 groove x 8', panel edging
800405 Plug, hardwood button, screw cover

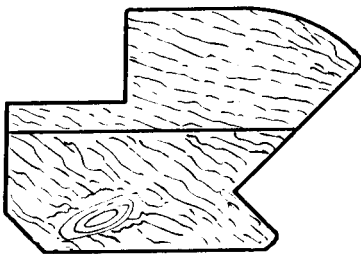

801209-004 Jamb,
Bathroom door

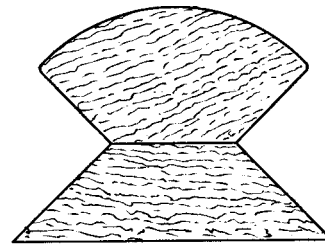

801282-004 Corner trim
1" radius

2001 SAFARI
WOOD/LAMINATES/TRIM

TRIM

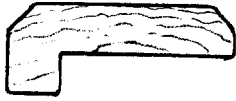

801617-014 Molding
Wainscoat, Oak

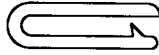

203225 Trim
lock, white



201728-03 Extrusion
plastic, ceiling trim,
White

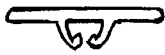

201728-01 Extrusion
Ceiling trim retainer
plastic



203159-02 Trim,
divider bar

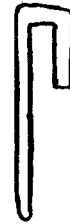

201666 Molding, "J"
trim,



203138-02
Extrusion, plastic
Panel edging, brown

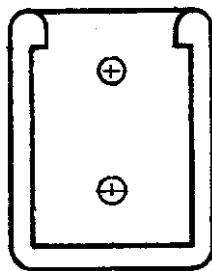

200003
End cap, header
support, brown

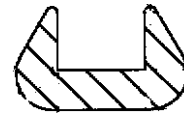

800766
Edge trim
Hardwood, Oak