

# Why AIRSTREAM?



**AIRSTREAM**<sup>®</sup>

A guide to the quality differences that  
make your experience unforgettable.



# What Makes an Airstream Travel Trailer *Different?*

If you're shopping for an RV, chances are you've wondered what makes an Airstream Travel Trailer different from other towable RVs on the market.

**If we have to answer in one word, it's *quality*.**

Airstream's commitment to quality began with our founder, Wally Byam. Way back in the 1930s, Wally started a tradition of innovation in RV design and laid the groundwork for a level of quality that meant Airstream Travel Trailers could be handed down from generation to generation. And while our world has changed a lot since Wally's time, our commitment to quality and innovative design remains just as strong.

**It takes an average of 350 hours and more than 3,000 rivets to build an iconic aluminum Airstream Travel Trailer.** Our way isn't the fastest or the easiest way to build an RV, but it is the right way. We don't believe in shortcuts, because they always leave you feeling shorted in the long run.

So, let's take a closer look at what building the right way means on our factory floor, and—more importantly—what it means to your life and your adventures to come.

[See this process in action in our \*\*video tour of the Airstream Travel Trailer plant.\*\*](#)

# Table of Contents

- 01 *Why* THE CURVED SHAPE?
- 02 *Why* BUILD THE EXTERIOR FIRST?
- 03 *Why* DO HANDCRAFTED COMPONENTS MATTER?
- 04 *Why* DO AIRSTREAMS HOLD THEIR VALUE?
- 05 *Why* DOES OUR DEALER NETWORK MATTER?
- 06 *Why* BECOME AN AIRSTREAMER?



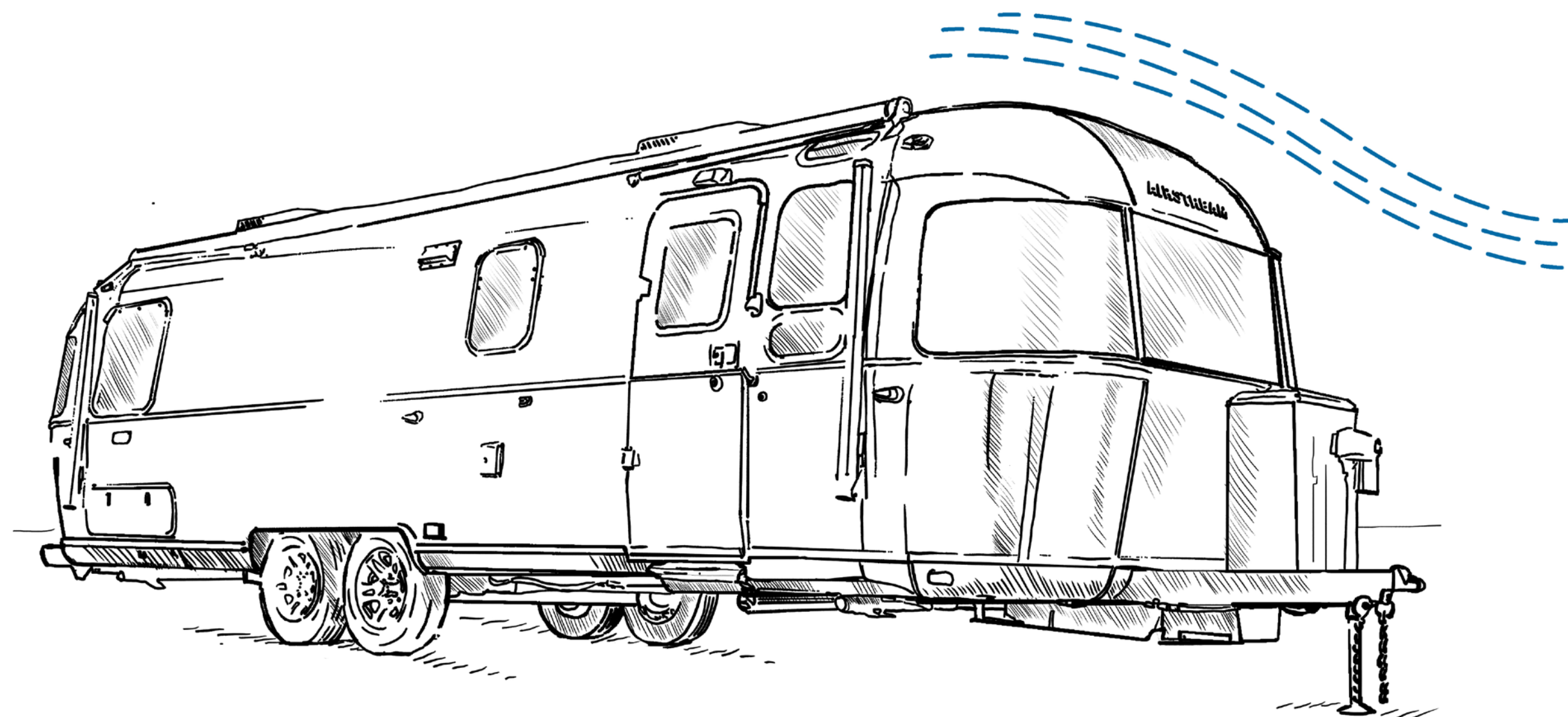
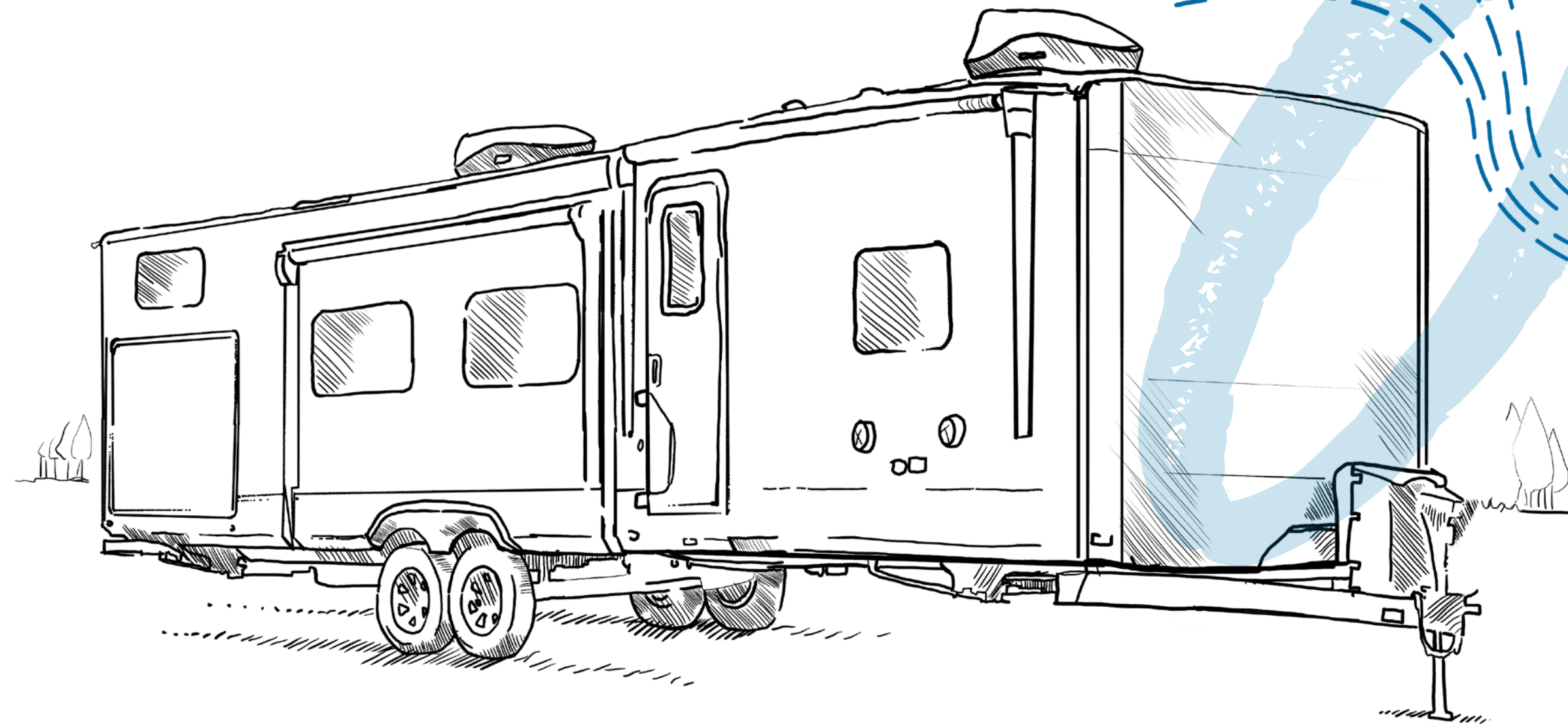

## Why the Curved *Shape?*

Most travel trailers are rectangular. Why are Airstream Travel Trailers curved?

When Wally Byam named the company Airstream, he said he wanted to design a travel trailer that would flow down the road like a stream of air. While designing his first travel trailers, Wally leaned into aerodynamic designs inspired by the architectural and design movements of the 1920s and '30s. His experience in the aircraft industry during WWII solidified Airstream's connection to the aviation world, with inspiration drawn from the aircraft of the day: lightweight enough to fly, curved to prevent wind resistance, and yet strong enough to withstand the elements.

That's why even to this day, all Airstream Travel Trailers consist of a curved aluminum outer shell for aerodynamic performance—one that we've continually improved over the years. The design is functional as well as gorgeous: Airstream's Travel Trailer designs result in less fuel consumption and longer travel in between fill-ups.

Want to see the study? [Watch our testing video and read more about results.](#)



# Why the Curved *Shape?*

So what do aerodynamics do for your experience?

Beyond the cool factor of having a travel trailer that's sure to turn heads on the highway, owning an Airstream has some very real benefits for your pocket and your travel experience.

- **More travel on less gas**

Your Airstream's aerodynamic design means fewer fill-ups and longer travel in between.

- **Reduce your carbon footprint**

An aerodynamic travel trailer means your tow vehicle is consuming less fuel while towing your Airstream, resulting in less of a carbon impact on the environment.

- **A smoother ride**

Due to its aerodynamic design, your Airstream is less susceptible to turbulence that could negatively impact your towing experience.

- **Prepared for electric vehicle towing**

We're always looking at what's next, and better aerodynamics will set you up for a smooth transition to an electric tow vehicle.

## Why Aluminum?

Another inspiration from the aircraft industry, aluminum is naturally lightweight, yet durable. That's why it's been our material of choice since the 1930s. Today's Airstream aluminum features a clear coat to inhibit UV damage and protect from yellowing, acid rain, flaking, cracks, pulverization, and mold.

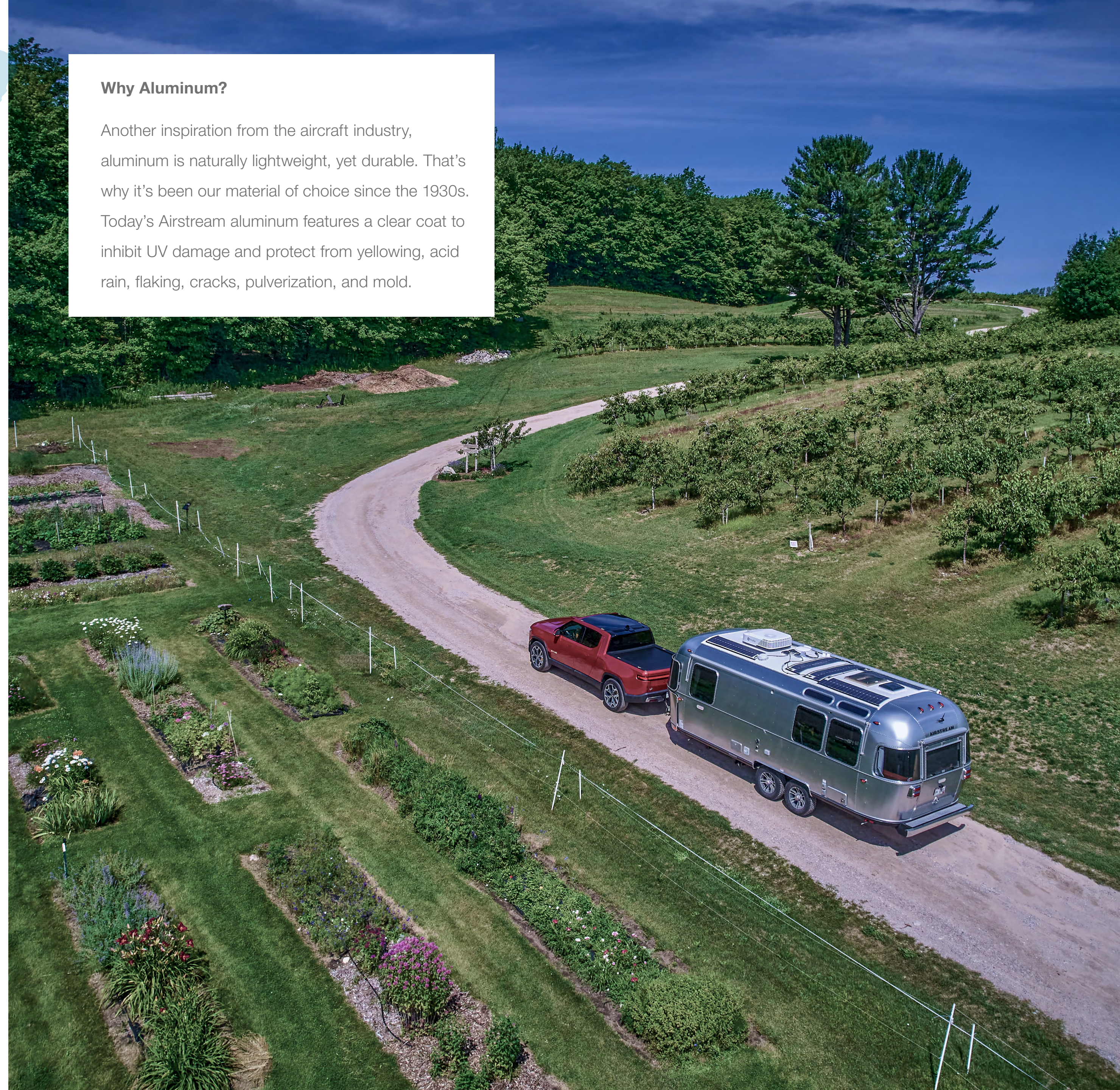

# Why Build the Exterior *First?*

Most travel trailers are built from the inside out.  
Why are Airstream Travel Trailers built from the outside in?

With other RV brands, you start with the chassis, build the floor on top, add furniture and everything that goes inside the living space, and then finish by adding the walls and ceiling. That's the opposite of how an Airstream Travel Trailer is made, and there's one key reason why: structural integrity.

WALLS BUILT FIRST

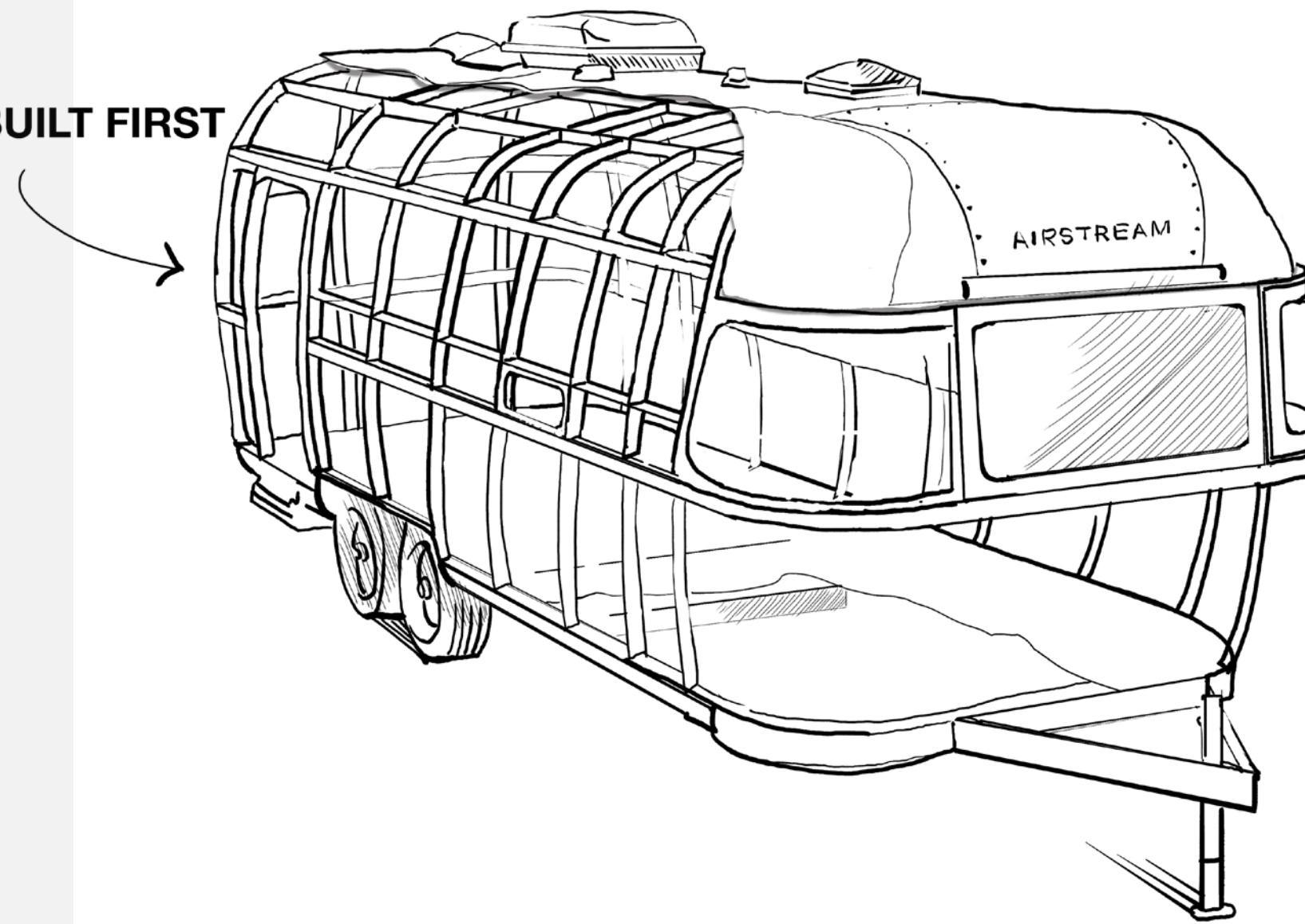

WALLS BUILT LAST

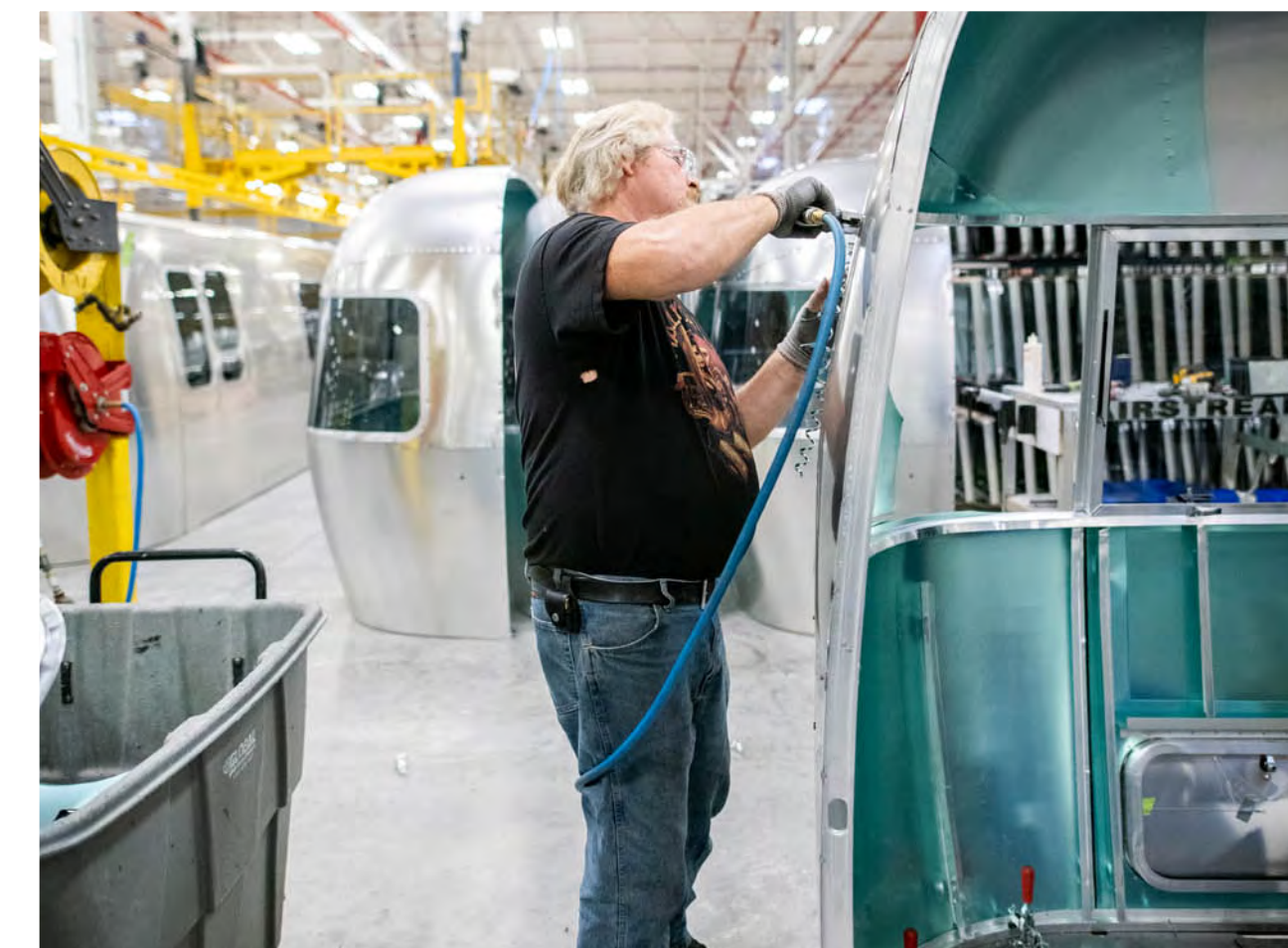
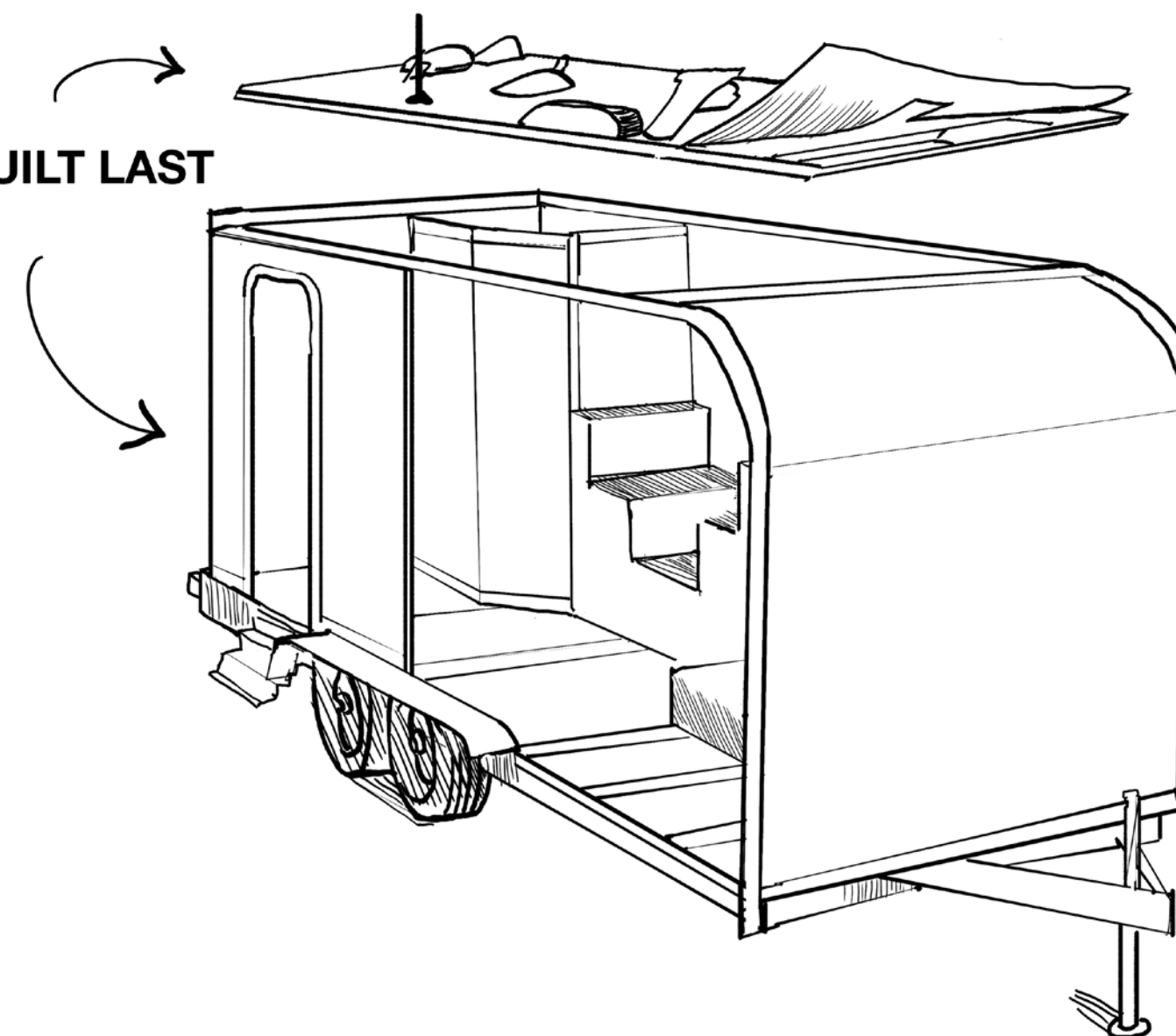

# Why Build the Exterior *First?*

The semi-monocoque superstructure

“Semi-monocoque” means combining a load-bearing shell with integral frames. Airplanes have semi-monocoque shells, which balance the need to be lightweight with the need to withstand intense forces. That’s exactly what an Airstream Travel Trailer’s aluminum shell is designed to do.

Here’s how we build it:

## 1. Start at the bottom

We start with a steel travel trailer chassis and add the water tanks, shock absorbers, stabilizer jacks, tires, wheels, and a multi-layer subfloor. This sets up the travel trailer with a low center of gravity for a smoother, easier towing experience.

## 2. Assemble the shell

While one team works on the chassis, another assembles the aluminum shell. Two riveters work together in tandem to fasten custom-shaped aluminum sheets together into one exterior load-bearing shell, attached to aluminum ribs for support.

## 3. Attach the shell to the floor

Once the shell is complete, we lift it via machine lifts in our factory; then, we pick up the entire shell and place it onto the chassis and travel trailer floor. The two pieces are attached permanently together to create the semi-monocoque superstructure.

## 4. Everything else goes in through the entry door

Once the superstructure is created, we never alter it. Every single piece of furniture and every appliance is engineered to fit through the entry door and is attached to the ultra-secure walls—instead of the other way around.

See this process in action in our [video tour of the Airstream Travel Trailer plant](#).





## Why Build the Exterior *First?*

What will a semi-monocoque superstructure do for you?

To put it simply, it lasts. Your Airstream is built for the road and all the bumps, winds, rains, and surprises that come with it.

- **Less wear and tear**

Because the furniture is attached to the superstructure, it's less likely to rattle, wobble, and come apart, even after generations on the road.

- **Protection from leaks**

Airstream aluminum seams are strategically placed, and each sheet is riveted tightly together and sealed. Before we start adding furniture, we send every Airstream through a high-pressure water test to ensure there are no leaks.

- **Better driving and towing**

Because your Airstream's center of gravity is lower than a typical box trailer, you get an inherently smoother towing experience with less sway.





## Why Do Handcrafted Components *Matter?*

Most RV companies use standard components that provide a path of least resistance. Why does Airstream create its own?

While we have outside partners for building components like our aluminum sheeting, window glass, tires, and appliances, we create as many components as possible ourselves. It's how we ensure the absolute highest quality.

Every single Airstream is assembled by hand in Jackson Center, Ohio, by hundreds of hardworking craftspeople. That includes engineering and manufacturing components you'll find in no other travel trailers on the market.

Our furniture is built in-house and assembled with dowel pins, stainless steel screws, and wood glue—not the industry-standard staples. Like our iconic aluminum shells, our furniture is built to stand the test of time and generations of adventure on the open road.

# Why Do Handcrafted Components *Matter?*

## Five Key Components We Craft Ourselves

### 1. Composite subfloor

Instead of the industry's standard plywood subfloor, we source a special state-of-the-art composite subfloor material and cut it and custom fit it ourselves. Not only does the composite naturally resist water better than plywood, but it also provides more screw retention and overall strength.

### 2. All-aluminum doors

The natural curvature of an Airstream Travel Trailer isn't the only reason we build our own entry doors from scratch. It's also because the entry door is one of the most important parts of the RV. That's why we cut, shape, weld, insulate, and assemble doors that shut like a bank vault for security.

### 3. Window frames

Once the shell is completely built upon its composite flooring, it's structurally sound enough to be hoisted via a machine lift and placed on the waiting chassis. Craftspeople bend, shape, and cut to exact measurements and clear coat each frame for long-lasting performance.

### 4. Wood furniture

While many other brands install prebuilt furniture and cabinetry, we take the time to custom-craft each cabinet, wardrobe, and seating base. Our wood shop team cuts, sands, and assembles using wood screws, dowels, and glue. We never use stapled particle board.

### 5. Custom-sewn curtains and upholstery

The custom blackout curtains in our Airstream Travel Trailers are unlike the thin fabric and minimal coverage found in some RVs. Each curtain is cut and sewn by our craftspeople, using industrial sewing machines right here in our factory. The majority of our upholstered seating is cut and sewn in-house as well.

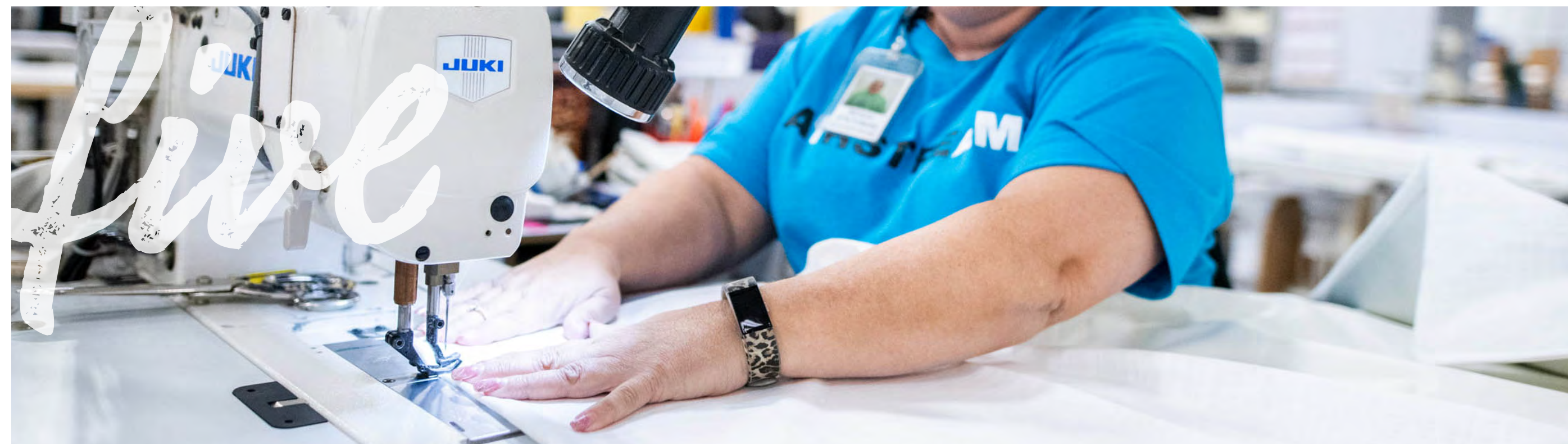

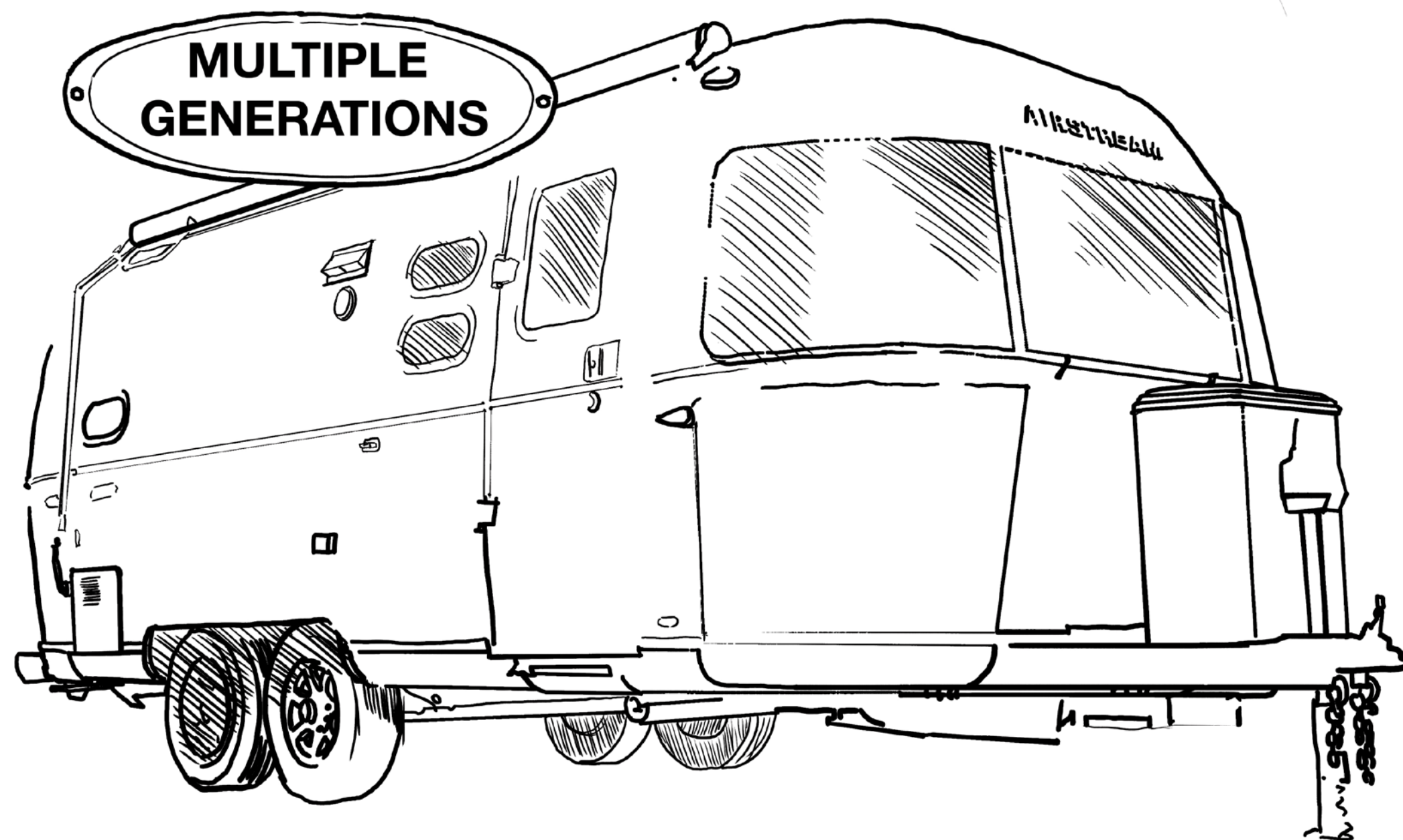
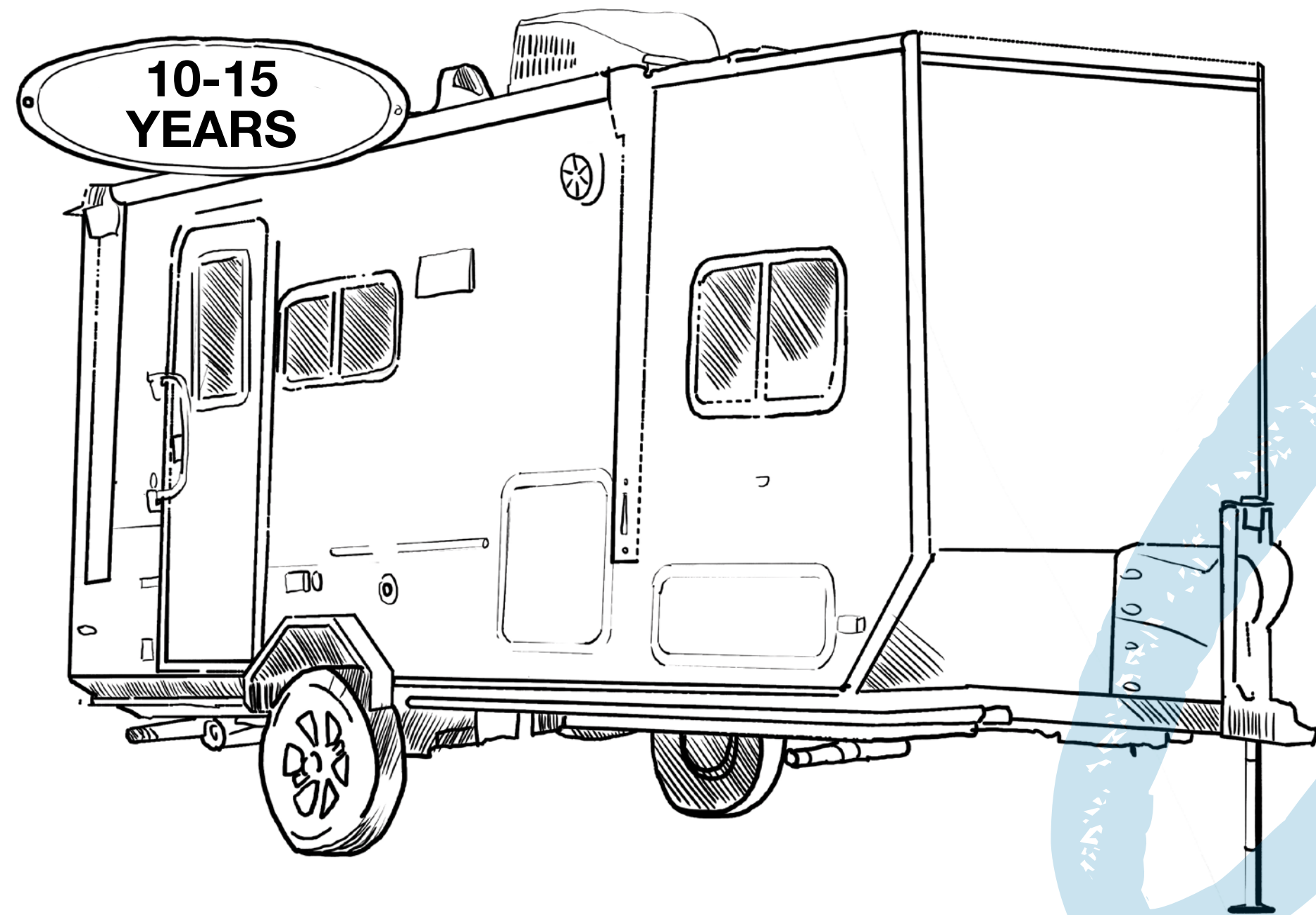

## Why Do Airstreams Hold Their *Value?*

Most travel trailers last about 15 years. Why do Airstream Travel Trailers last multiple generations?

By now, you've gotten a feel for some of the individual choices that make Airstream Travel Trailers different from other RVs on the market. **But the thing that really makes an Airstream Travel Trailer last for decades is the way all these choices come together in a complete package.** It's why—for nearly 100 years – Airstream Travel Trailers have been passed down to family members or other travelers with the same adventurous spirit.

# Why Do Airstreams Hold Their *Value?*

## 1. Quality built in

Before your Airstream Travel Trailer leaves the production line, **quality control experts confirm 1,500 points of inspection**, including testing the appliances, pressure checking the LP gas system, filling the drain system to check for plumbing leaks, and so much more. We're not just thinking about your first trip in your new Airstream when we do these checks; we're thinking about years of use. And we won't roll your Airstream off the line until it's just right.

## 2. Great resale value

The Airstream resale market is booming and has been for decades. **Pre-owned Airstreams often fetch prices as high as their original listing price**, which is a testament to just how well the quality and design withstand the tests of time.

## 3. Lower cost to own

When you amortize the purchase price over its length of service, an Airstream actually costs less to own than many other travel trailers. **That means a smart investment in quality now pays off in the long run.**





# Why Does Our Dealer Network *Matter?*

Take advantage of a dealer network that's close by, knowledgeable, and ready to give you the very best sales, service, and ownership experience available.

**Close to Where You are:** We have Airstream dealers located all across the country—no matter where you live, you're not far from the best dealer experience in the industry. And when you need regular maintenance or repair work done, close proximity means you can get back on the road on your schedule. While some RV brands have a single facility far from the action, you can trust Airstream's national dealer network to be ready to help you—no matter where you are.

**Knowledgeable in Sales and Service:** Our dealers regularly travel to our headquarters in Jackson Center, Ohio, where they learn about new models, new features, and new innovations that make Airstreams the very best RVs on the market. When it comes to service, our dealers are constantly training on the very best techniques gleaned from decades of expertise.

**The Best Experience Possible:** From friendly staff who appreciate the iconic nature and generational appeal of the Airstream Travel Trailer, to service techs who can help tackle everything from routine maintenance to bigger repairs, Airstream's nationwide dealer network is unparalleled. And when you visit one of our Five Rivet Dealers, you can rest assured that you are working with dealers who have met stringent guidelines based on feedback from customers just like you.



## Why Become an *Airstreamer?*

There are millions of RVers out there. Why become an Airstreamer?

Ever since the very first days of Airstream in the 1930s, it's been about creating not just innovative RVs, but a truly unique way of life. For nearly 100 years, Airstreamers have shared their passion for life, travel, adventure, and enduring camaraderie. It's a quality that's hard to put into words, but when you're an Airstreamer, you can feel that you're part of something bigger. Hundreds of thousands of Airstreamers set out to see what's over the next hill, and do it in absolute comfort. You'll be welcomed with open arms.

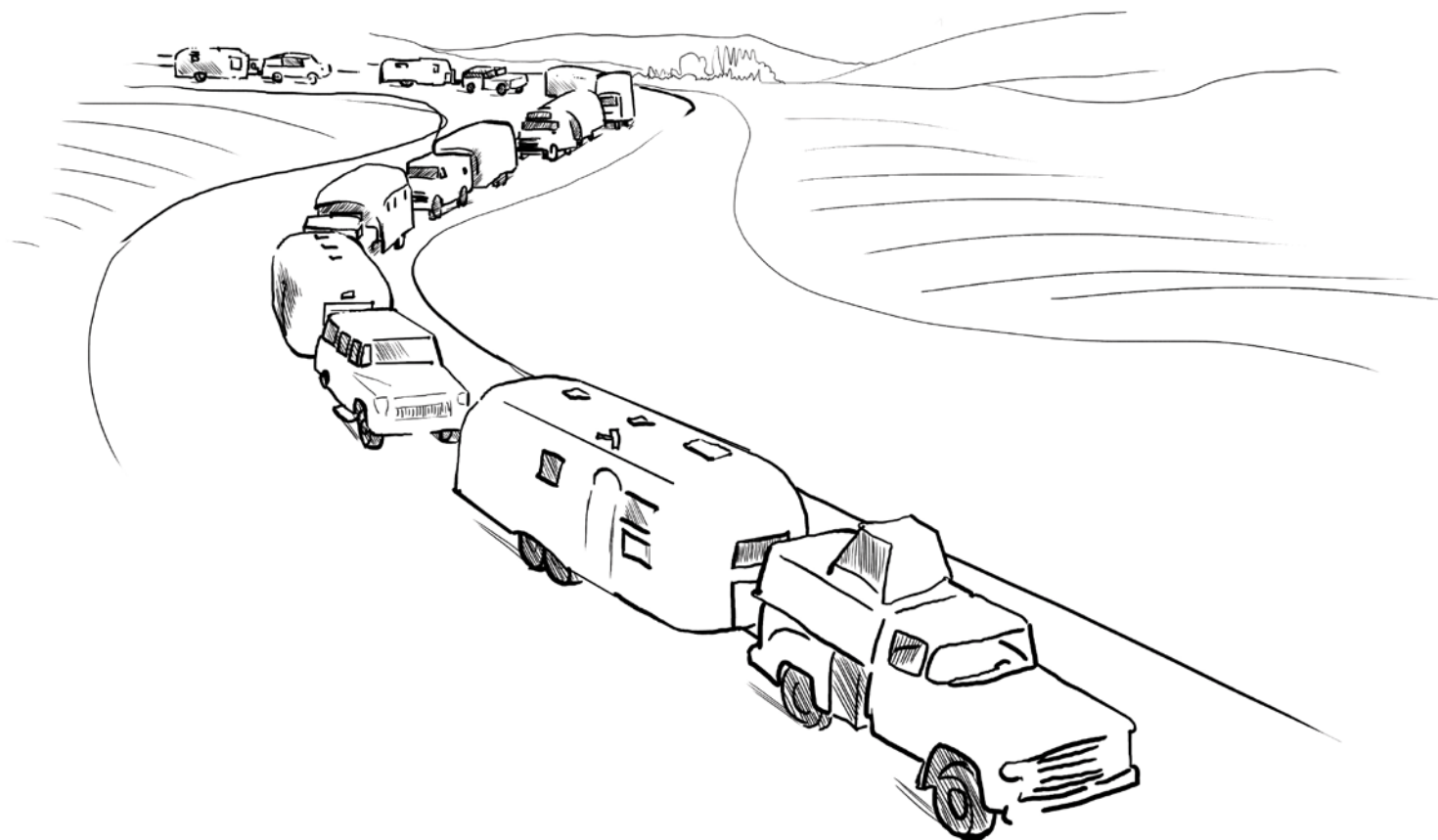

# Why Become an *Airstreamer?*

## Airstream Club International

Inspired by the first continent-spanning Airstream caravans of the 1950s and '60s, Airstream Club International hosts weekend or week-long rallies and Caravans through every corner of North America and Airstream-specific campgrounds in several states. Wherever you go, you'll be surrounded by friends who know the ins and outs of Airstreams and life on the road.



*"In the heart of these words is an entire life's dream. To those of you who find in the promise of these words your promise, I bequeath this creed... my dream belongs to you."*

**Wally Byam**

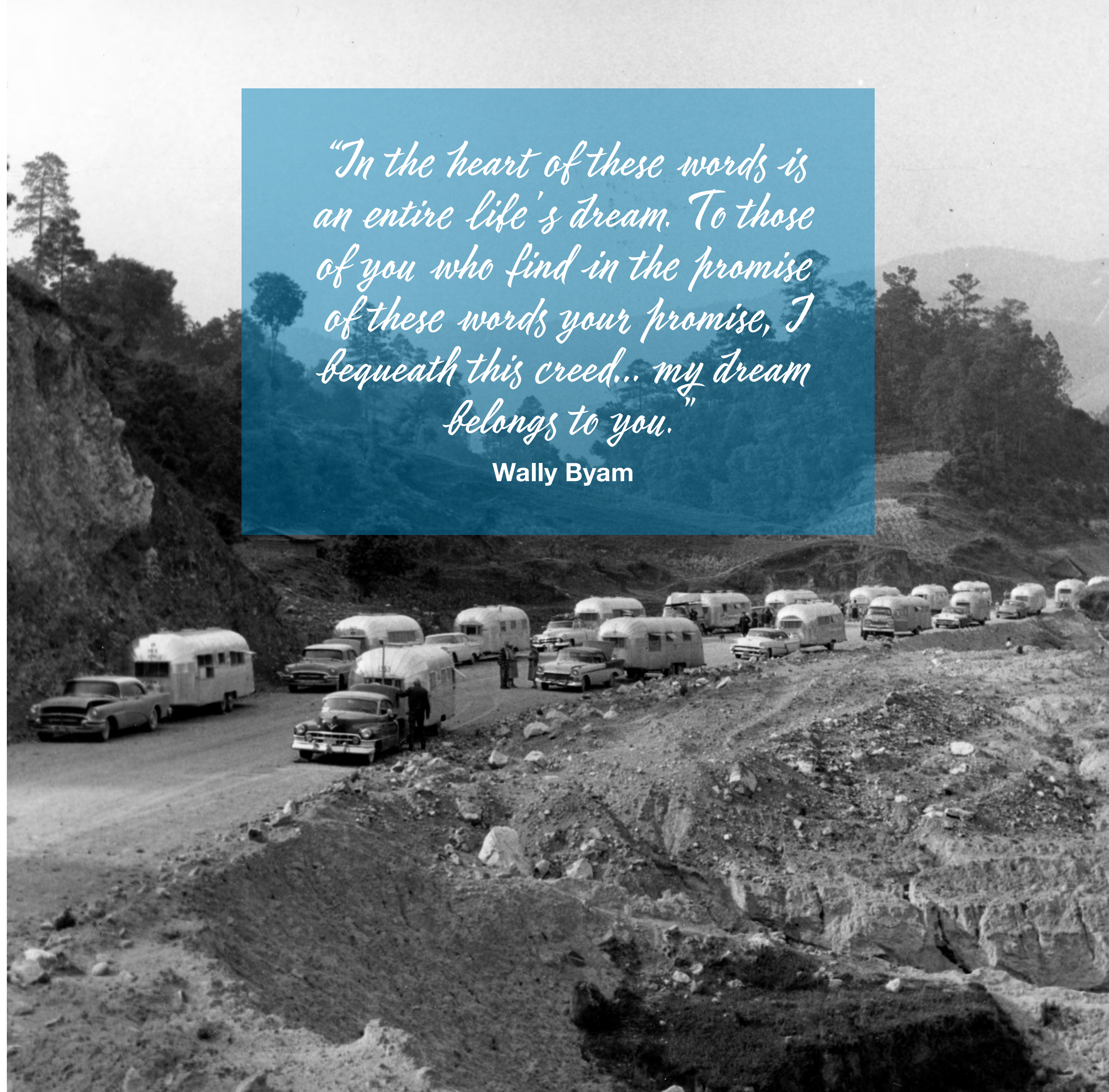

# More Questions? We Have *Answers.*

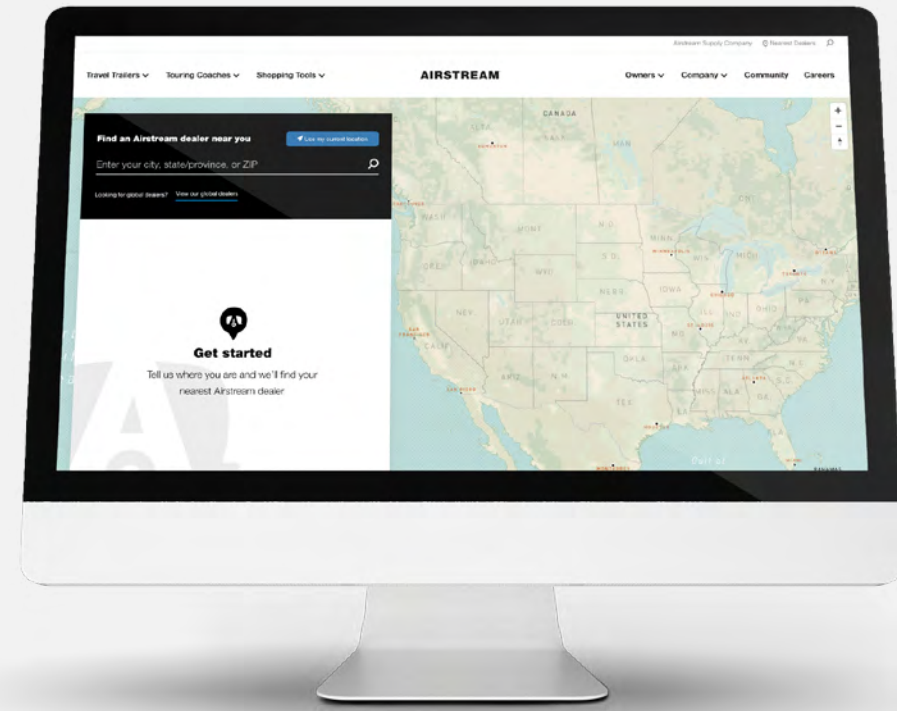

## National Dealer Network

While you're shopping, you're bound to have specific questions about certain models, features, and more. Whether you're still researching or ready to buy tomorrow, your Airstream dealer is here to help you get the answers you need. Find your dealer and take a zero-pressure walkthrough in person.

[Find Your Dealer](#)

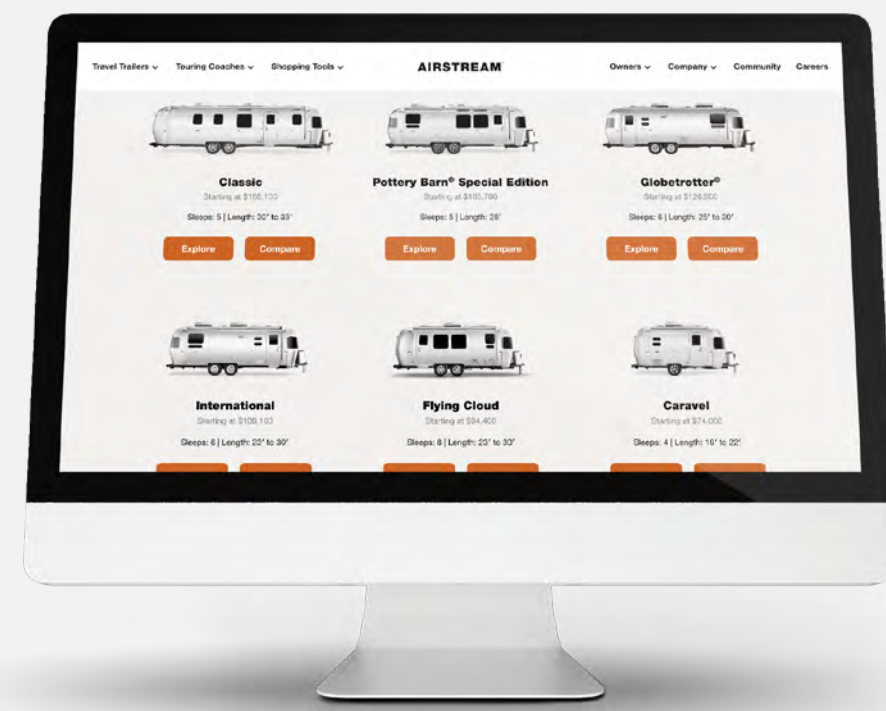

## See All Airstream Travel Trailers

Take a closer look at all the current Airstream Travel Trailer models and floor plans, and find the right one for you.

[Explore Travel Trailers](#)

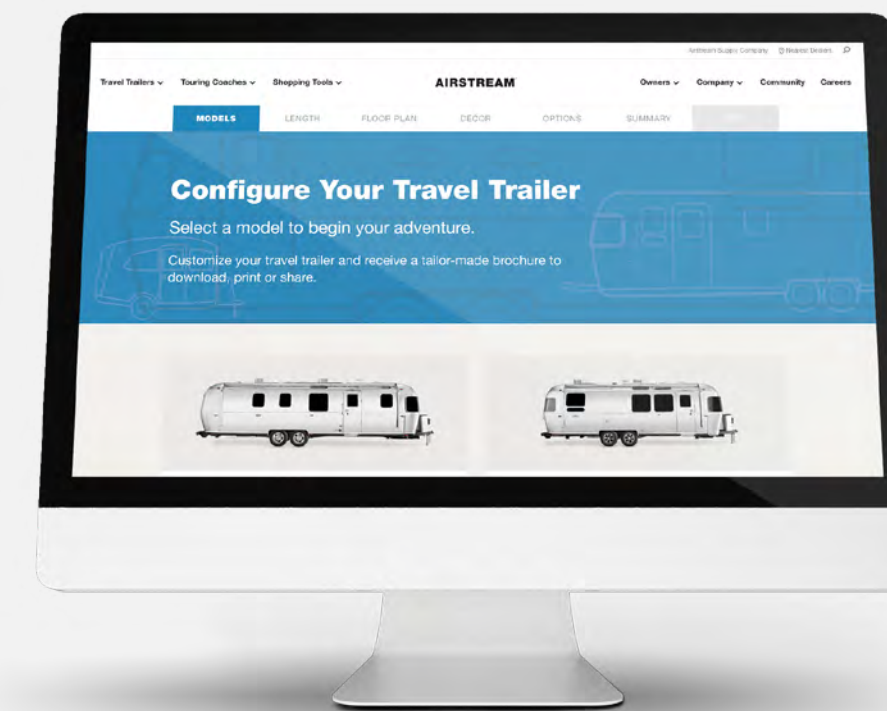

## Configure Your Perfect Airstream

Start with any model and choose a floor plan, interior décor, and additional options that feel right for you. When you're done configuring, you'll receive a tailor-made brochure to download, print, or share.

[Configure Yours](#)

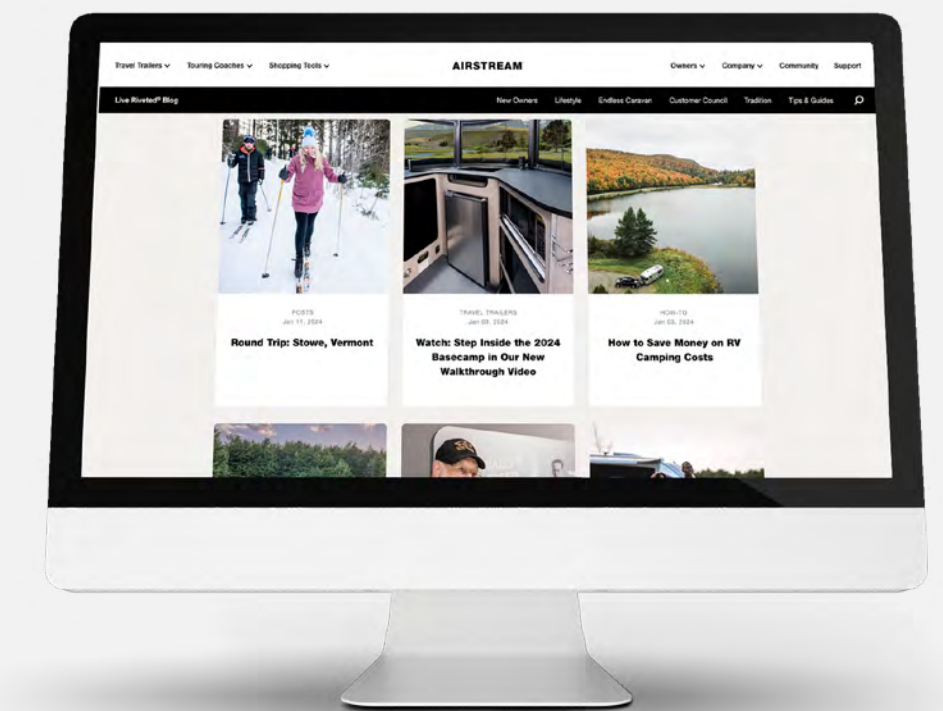

## Explore Our Blogs

Connect to our community by diving in to our blog, where you'll find compelling stories and valuable perspectives.

[Read More](#)





#LiveRiveted

Thousands of rivets hold an Airstream Travel Trailer together as it rolls down the highway. Likewise, our community of travelers, adventurers, and explorers is held together by our desire to live every moment to its fullest. So, what are you waiting for? Learn more about Airstream and discover how you can embrace the freedom and Live Riveted.

[Find your Travel Trailer at Airstream.com](https://www.airstream.com)

Share on Social

